

# BQ25600 and BQ25600D 用于高输入电压和 NVDC 电源路径管理的 I<sup>2</sup>C 控制型单节电池 3.0A 降压电池充电器

## 1 特性

- 高效 1.5 MHz 同步开关模式降压充电器
  - 在 2A 电流 (5V 输入) 下具有 92% 的充电效率
  - 针对 USB 电压输入 (5V) 进行了优化
  - 用于轻负载运行的可选低功耗脉冲频率调制 (PFM) 模式
- 支持 USB On-The-Go (OTG)
  - 具有高达 1.2A 输出的升压转换器
  - 在 1A 输出下具有 92% 的升压效率
  - 精确的恒定电流 (CC) 限制
  - 高达 500 $\mu$ F 容性负载的软启动
  - 输出短路保护
  - 低功耗 PFM 模式, 适合轻载运行
- 单个输入, 支持 USB 输入和高电压适配器
  - 支持 3.9V 至 13.5V 输入电压范围, 绝对最大输入电压额定值为 22V
  - 可编程输入电流限制 (100 mA 至 3.2A, 分辨率为 100 mA), 支持 USB 2.0、USB 3.0 标准和高压适配器 (IINDPM)
  - 通过高达 5.4V 的输入电压限制 (VINDPM) 进行最大功率跟踪
  - VINDPM 阈值自动跟踪电池电压
  - 自动检测 USB SDP、DCP 以及非标准适配器
- 高电池放电效率, 电池放电 MOSFET 为 19.5 m $\Omega$
- 窄 VDC (NVDC) 电源路径管理
  - 无需电池或深度放电的电池即可瞬时启动
  - 电池充电模式下实现理想二极管运行
- BATFET 控制, 支持运输模式、唤醒和完全系统复位
- 灵活的自主和 I<sup>2</sup>C 模式, 可实现最优系统性能
- 高集成度, 包括所有 MOSFET、电流感测和环路补偿

- 17 $\mu$ A 低电池泄漏电流
- 高精度
  - 充电电压调节范围为  $\pm 0.5\%$
  - 1.38A 充电电流调节范围为  $\pm 6\%$
  - 0.9A 输入电流调节范围为  $\pm 10\%$
  - 用于快速充电的远程电池感应

## 2 应用

- 智能手机
- 手机附件
- 医疗设备

## 3 说明

BQ25600 and BQ25600D 是高度集成的 3.0A 开关模式电池充电管理和系统电源路径管理器件, 适用于单节锂离子和锂聚合物电池。其低阻抗电源路径对开关模式运行效率进行了优化、缩短了电池充电时间并延长了放电阶段的电池使用寿命。具有充电和系统设置的 I<sup>2</sup>C 串行接口使得此器件成为一种真正灵活的解决方案。

### 器件信息

器件型号	封装 <sup>(1)</sup>	封装尺寸 (标称值)
BQ25600	WCSP (30)	2.00mm $\times$ 2.40mm
BQ25600D		

(1) 如需了解所有可用封装, 请参阅数据表末尾的可订购产品附录。

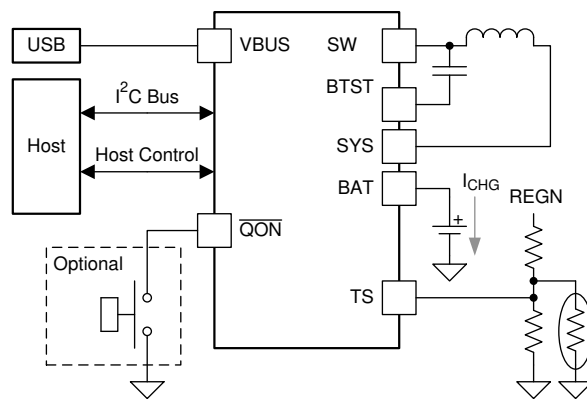

简化版应用



## Table of Contents

1 特性.....	1	8.5 Programming.....	33
2 应用.....	1	8.6 Register Maps.....	36
3 说明.....	1	<b>9 Application and Implementation.....</b>	<b>47</b>
4 Revision History.....	2	9.1 Application Information.....	47
5 说明 (续).....	4	9.2 Typical Application.....	48
6 Pin Configuration and Functions.....	5	<b>10 Power Supply Recommendations.....</b>	<b>55</b>
7 Specifications.....	8	<b>11 Layout.....</b>	<b>56</b>
7.1 Absolute Maximum Ratings.....	8	11.1 Layout Guidelines.....	56
7.2 ESD Ratings.....	8	11.2 Layout Example.....	56
7.3 Recommended Operating Conditions.....	8	<b>12 Device and Documentation Support.....</b>	<b>57</b>
7.4 Thermal Information.....	9	12.1 Device Support.....	57
7.5 Electrical Characteristics.....	9	12.2 接收文档更新通知.....	57
7.6 Timing Requirements.....	14	12.3 支持资源.....	57
7.7 Typical Characteristics.....	16	12.4 Trademarks.....	57
<b>8 Detailed Description.....</b>	<b>18</b>	12.5 Electrostatic Discharge Caution.....	57
8.1 Overview.....	18	12.6 术语表.....	57
8.2 Functional Block Diagram.....	19	<b>13 Mechanical, Packaging, and Orderable Information.....</b>	<b>58</b>
8.3 Feature Description.....	20		
8.4 Device Functional Modes.....	29		

## 4 Revision History

注：以前版本的页码可能与当前版本的页码不同

Changes from Revision A (August 2017) to Revision B (March 2022)	Page
• 删除了整个数据表中的 WEBENCH.....	1
• Deleted V <sub>REGN</sub> MAX values in Electrical Characteristics table.....	9
• Added last sentence to 节 8.3.3.5.....	22
• Changed 图 8-3.....	25
• Changed 图 8-4.....	25
• Added 图 8-5.....	25
• Changed 图 8-6.....	26
• Added 节 8.4.....	29
• Changed 图 8-7.....	29
• Changed description of exiting shipping mode from $\overline{QON}$ pin.....	31
• Added 节 8.5.....	33
• Changed BQ25600 010 to 011 in Description in 表 8-15.....	44
• Deleted $\overline{PG}$ pin in 图 9-2.....	48
• Added 表 9-1.....	49

Changes from Revision * (June 2017) to Revision A (August 2017)	Page
• 更改了数据表标题.....	1
• 从节 1 中删除了“200 nS 快速关闭”.....	1
• 更改了简化版应用原理图.....	1
• Deleted ACDRV pin references from Pin Functions table.....	5
• Changed VAC pin description in Pin Functions table.....	5
• Changed ACDRV pin references to "NC" in 节 6 section.....	5
• Deleted ACDRV pin references from 节 7.1 table.....	8
• Added Input supply current specification (I <sub>VACVBUS_HIZ</sub> ) in Electrical Characteristics table.....	9
• Changed 节 8.2.....	19
• Changed Power Up from Input Source section.....	20

---

• Deleted Power Up OVPFET section.....	20
• Deleted OVPFET Startup Control timing illustration .....	20
• Added subsection explaining D+/D - detection .....	21
• Changed Input Overvoltage (ACOV) section.....	27
• Changed Power Path Management Application schematic.....	48
• Changed BQ25600D Applications Diagram schematic .....	48

---

## 5 说明 (续)

BQ25600 and BQ25600D 支持高输入电压和快速充电功能，适用于各类智能手机、平板电脑和便携式设备。其输入电压和电流调节以及电池远程感应可以为电池提供最大的充电功率。它还集成了一个自举二极管以进行高侧栅极驱动，从而简化了系统设计。具有充电和系统设置的 I<sup>2</sup>C 串行接口使得此器件成为一个真正灵活的解决方案。

该器件支持多种输入源，包括标准 USB 主机端口、USB 充电端口以及兼容 USB 的高电压适配器。该器件根据内置 USB 接口设置默认输入电流限值。为了设置默认输入电流限值，该器件使用内置 USB 接口或者从系统检测电路（如 USB PHY 器件）中获取结果。该器件符合 USB 2.0 和 USB 3.0 电源规范，具有输入电流和电压调节功能。该器件还具有高达 1.2 A 的恒定电流限制能力，能够为 VBUS 提供 5.15V 的电压，符合 USB On-the-Go (OTG) 运行功率额定值规格。

电源路径管理将系统电压调节至稍高于电池电压的水平，但是不会下降至 3.5V 最小系统电压（可编程）以下。借助于这个特性，即使在电池电量完全耗尽或者电池被拆除时，系统也能保持运行。当达到输入电流限值或电压限值时，电源路径管理技术自动将充电电流减至 0。随着系统负载持续增加，电源路径将使电池放电，直到满足系统电源需求。这种补充模式可防止输入源过载。

此器件无需软件控制即可启动并完成一个充电周期。它可感测电池电压并分三个阶段为电池充电：预充电、恒定电流和恒定电压。在充电周期结束时，当充电电流低于预设限值并且电池电压高于再充电阈值时，充电器自动终止。如果充满电的电池降至再充电阈值以下，则充电器自动开启另一个充电周期。

此充电器提供针对电池充电和系统运行的多种安全特性，其中包括电池负温度系数热敏电阻监视、充电安全性计时器和过压/过流保护。当结温超过 110°C（可编程）时，热调节会使充电电流减小。STAT 输出报告充电状态和任何故障状况。其他安全特性包括针对充电和升压模式的电池温度感应、热调节和热关断以及输入 UVLO 和过压保护。VBUS\_GD 位指示电源是否正常。当故障发生时， $\overline{\text{INT}}$  输出会立即通知主机。

该器件还提供用于 BATFET 使能和复位控制的  $\overline{\text{QON}}$  引脚，用以退出低功耗运输模式或完全系统复位功能。

该器件系列采用 30 焊球 2.0mm × 2.4mm WCSP 封装。

## 6 Pin Configuration and Functions



图 6-1. BQ25600 YFF Package 30-Pin WCSP Top View



图 6-2. BQ25600D YFF Package 30-Pin WCSP Top View

表 6-1. Pin Functions

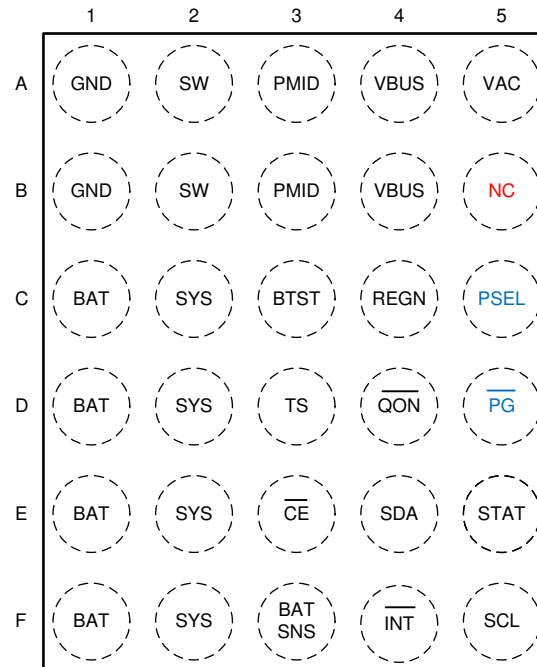
NAME	PIN		TYPE <sup>(1)</sup>	DESCRIPTION
	BQ25600	BQ25600D		
	WCSP	WCSP		
BAT	C1	C1	P	Battery connection point to the positive terminal of the battery pack. The internal current sensing resistor is connected between SYS and BAT. Connect a 10 $\mu$ F closely to the BAT pin.
	D1	D1		
	E1	E1		
	F1	F1		
BATSNS	F3	F3	AIO	Battery voltage sensing pin for charge current regulation. In order to minimize the parasitic trace resistance during charging, BATSNS pin is connected to the actual battery pack as close as possible.
BTST	C3	C3	P	PWM high side driver positive supply. Internally, the BTST is connected to the cathode of the boost-strap diode. Connect the 0.047- $\mu$ F bootstrap capacitor from SW to BTST.
CE	E3	E3	DI	Charge enable pin. When this pin is driven low, battery charging is enabled.
D+	—	C5	AIO	Positive line of the USB data line pair. D+/D- based USB host/charging port detection. The detection includes data contact detection (DCD), primary and secondary detection in BC1.2.
D-	—	D5	AIO	Negative line of the USB data line pair. D+/D- based USB host/charging port detection. The detection includes data contact detection (DCD), primary and secondary detection in BC1.2.
GND	A1	A1	P	Ground
	B1	B1		
INT	F4	F4	DO	Open-drain interrupt Output. Connect the INT to a logic rail through 10-k $\Omega$ resistor. The INT pin sends active low, 256- $\mu$ s pulse to host to report charger device status and fault.
NC	B5	B5		No connection. This pin must be floating.
PG	D5	—	DO	Open drain active low power good indicator. Connect to the pull up rail through 10 k $\Omega$ resistor. LOW indicates a good input source if the input voltage is between UVLO and ACOV, above SLEEP mode threshold, and current limit is above 30 mA.
PMID	A3	A3	DO	Connected to the drain of the reverse blocking MOSFET (RBFET) and the drain of HSFET. Given the total input capacitance, put 1 $\mu$ F on VBUS to GND, and the rest capacitance on PMID to GND.
	B3	B3		
PSEL	C5	—	DI	Power source selection input. High indicates 500 mA input current limit. Low indicates 2.4A input current limit. Once the device gets into host mode, the host can program different input current limit to IINDPM register.
QON	D4	D4	DI	BATFET enable/reset control input. When BATFET is in ship mode, a logic low of $t_{SHIPMODE}$ duration turns on BATFET to exit shipping mode. When VBUS is not plugged-in, a logic low of $t_{QON\_RST}$ (minimum 8 s) duration resets SYS (system power) by turning BATFET off for $t_{BATFET\_RST}$ (minimum 250 ms) and then re-enable BATFET to provide full system power reset. The pin contains an internal pull-up to maintain default high logic.
REGN	C4	C4	P	PWM low side driver positive supply output. Internally, REGN is connected to the anode of the boost-strap diode. Connect a 4.7- $\mu$ F (10-V rating) ceramic capacitor from REGN to analog GND. The capacitor should be placed close to the IC.
SCL	F5	F5	DI	I <sup>2</sup> C interface clock. Connect SCL to the logic rail through a 10-k $\Omega$ resistor.
SDA	E4	E4	DIO	I <sup>2</sup> C interface data. Connect SDA to the logic rail through a 10-k $\Omega$ resistor.
STAT	E5	E5	DO	Open-drain interrupt output. Connect the STAT pin to a logic rail via 10-k $\Omega$ resistor. The STAT pin indicates charger status. Charge in progress: LOW Charge complete or charger in SLEEP mode: HIGH Charge suspend (fault response): Blink at 1Hz
SW	A2	A2	P	Switching node connecting to output inductor. Internally SW is connected to the source of the n-channel HSFET and the drain of the n-channel LSFET. Connect the 0.047- $\mu$ F bootstrap capacitor from SW to BTST.
	B2	B2		
SYS	C2	C2	P	Converter output connection point. The internal current sensing resistor is connected between SYS and BAT. Connect a 20 $\mu$ F closely to the SYS pin.
	D2	D2		
	E2	E2		
	F2	F2		

**表 6-1. Pin Functions (continued)**

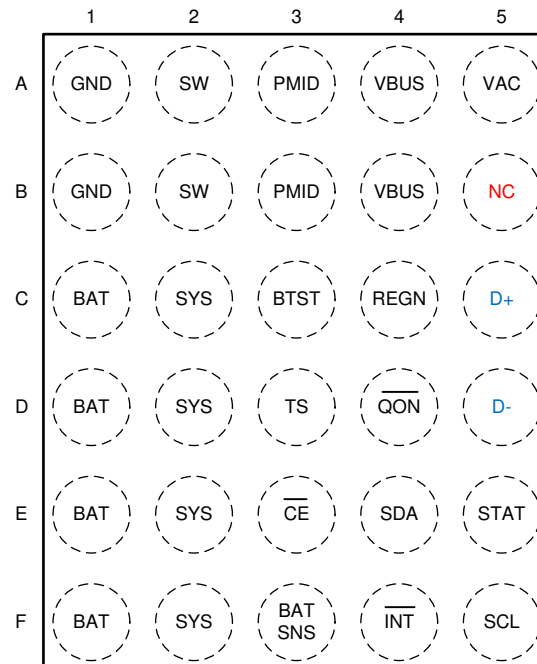
NAME	PIN		TYPE <sup>(1)</sup>	DESCRIPTION
	BQ25600	BQ25600D		
	WCSP	WCSP		
Thermal Pad	—	—	P	Ground reference for the device that is also the thermal pad used to conduct heat from the device. This connection serves two purposes. The first purpose is to provide an electrical ground connection for the device. The second purpose is to provide a low thermal-impedance path from the device die to the PCB. This pad should be tied externally to a ground plane.
TS	D3	D3	AI	Temperature qualification voltage input to support JEITA profile. Connect a negative temperature coefficient thermistor. Program temperature window with a resistor divider from REGN to TS to GND. Charge suspends when TS pin voltage is out of range. When TS pin is not used, connect a 10-k $\Omega$ resistor from REGN to TS and a 10-k $\Omega$ resistor from TS to GND. It is recommended to use a 103AT-2 thermistor.
VAC	A5	A5	AI	Input voltage sensing. This pin must be tied to VBUS.
VBUS	A4	A4	P	Charger input voltage. The internal n-channel reverse block MOSFET (RBFET) is connected between VBUS and PMID with VBUS on source. Place a 1-uF ceramic capacitor from VBUS to GND and place it as close as possible to IC.
	B4	B4		

(1) AI = Analog input, AO = Analog Output, AIO = Analog input Output, DI = Digital input, DO = Digital Output, DIO = Digital input Output, P = Power

## 7 Specifications

### 7.1 Absolute Maximum Ratings

over operating free-air temperature range (unless otherwise noted)<sup>(1)</sup>

		MIN	MAX	UNIT
Voltage Range (with respect to GND)	VAC	- 2	22	V
Voltage Range (with respect to GND)	VBUS (converter not switching) <sup>(2)</sup>	- 2	22	V
Voltage Range (with respect to GND)	BTST, PMID (converter not switching) <sup>(2)</sup>	- 0.3	22	V
Voltage Range (with respect to GND)	SW	- 2	16	V
Voltage Range (with respect to GND)	BTST to SW	- 0.3	7	V
Voltage Range (with respect to GND)	PSEL	- 0.3	7	V
Voltage Range (with respect to GND)	D+, D -	- 0.3	7	V
Voltage Range (with respect to GND)	BATSNS (converter not switching)	- 0.3	7	V
Voltage Range (with respect to GND)	REGN, TS, $\overline{CE}$ , $\overline{PG}$ , BAT, SYS (converter not switching)	- 0.3	7	V
Output Sink Current	STAT		6	mA
Voltage Range (with respect to GND)	SDA, SCL, $\overline{INT}$ , $\overline{QON}$ , STAT	- 0.3	7	V
Voltage Range (with respect to GND)	PGND to GND (QFN package only)	- 0.3	0.3	V
Output Sink Current	$\overline{INT}$		6	mA
Operating junction temperature, $T_J$		- 40	150	°C
Storage temperature, $T_{stg}$		- 65	150	°C

- (1) Stresses beyond those listed under Absolute maximum Ratings may cause permanent damage to the device. These are stress ratings only, which do not imply functional operation of the device at these or any other conditions beyond those indicated under Recommended Operating Conditions. Exposure to absolute-maximum-rated conditions for extended periods may affect device reliability. All voltage values are with respect to the network ground terminal unless otherwise noted.
- (2) VBUS is specified up to 22 V for a maximum of one hour at room temperature

### 7.2 ESD Ratings

		VALUE	UNIT
$V_{(ESD)}$	Electrostatic discharge	Human body model (HBM), per ANSI/ESDA/JEDEC JS-001, all pins <sup>(1)</sup>	V
		Charged device model (CDM), per JEDEC specification JESD22-C101, all pins <sup>(2)</sup>	

- (1) JEDEC document JEP155 states that 500-V HBM allows safe manufacturing with a standard ESD control process.
- (2) JEDEC document JEP157 states that 250-V CDM allows safe manufacturing with a standard ESD control process.

### 7.3 Recommended Operating Conditions

		MIN	NOM	MAX	UNIT
$V_{BUS}$	Input voltage	3.9		13.5 <sup>(1)</sup>	V
$I_{in}$	Input current (VBUS)			3.25	A
$I_{SWOP}$	Output current (SW)			3.25	A



### 7.3 Recommended Operating Conditions (continued)

		MIN	NOM	MAX	UNIT
V <sub>BATOP</sub>	Battery voltage			4.624	V
I <sub>BATOP</sub>	Fast charging current			3.0	A
I <sub>BATOP</sub>	Discharging current (continuous)			6	A
T <sub>A</sub>	Operating ambient temperature	- 40		85	°C

- (1) The inherent switching noise voltage spikes should not exceed the absolute maximum voltage rating on either the BTST or SW pins. A tight layout minimizes switching noise.

### 7.4 Thermal Information

THERMAL METRIC		BQ25600(D)	UNIT
		YFF (DSBGA)	
		30 Balls	
R <sub>θJA</sub>	Junction-to-ambient thermal resistance	58.8	°C/W
R <sub>θJC(top)</sub>	Junction-to-case (top) thermal resistance	0.2	°C/W
R <sub>θJB</sub>	Junction-to-board thermal resistance	8.3	°C/W
Ψ <sub>JT</sub>	Junction-to-top characterization parameter	1.4	°C/W
Ψ <sub>JB</sub>	Junction-to-board characterization parameter	8.3	°C/W
R <sub>θJC(bot)</sub>	Junction-to-case (bottom) thermal resistance	N/A	°C/W

### 7.5 Electrical Characteristics

V<sub>VAC\_UVLOZ</sub> < V<sub>VAC</sub> < V<sub>VAC\_OV</sub> and V<sub>VAC</sub> > V<sub>BAT</sub> + V<sub>SLEEP</sub>, T<sub>J</sub> = - 40°C to 125°C and T<sub>J</sub> = 25°C for typical values (unless otherwise noted)

PARAMETER	TEST CONDITIONS	MIN	TYP	MAX	UNIT
<b>QUIESCENT CURRENTS</b>					
I <sub>BAT</sub>	Battery discharge current (BAT, SW, SYS) in buck mode	V <sub>BAT</sub> = 4.5 V, V <sub>BUS</sub> < V <sub>VAC_UVLOZ</sub> , leakage between BAT and VBUS, T <sub>J</sub> < 85°C		5	μA
I <sub>BAT</sub>	Battery discharge current (BAT) in buck mode	V <sub>BAT</sub> = 4.5 V, HIZ Mode and OVPFET_DIS = 1 or No VBUS, I2C disabled, BATFET Disabled. T <sub>J</sub> < 85°C	17	33	μA
I <sub>BAT</sub>	Battery discharge current (BAT, SW, SYS)	V <sub>BAT</sub> = 4.5 V, HIZ Mode and OVPFET_DIS = 1 or No VBUS, I2C Disabled, BATFET Enabled. T <sub>J</sub> < 85°C	58	85	μA
I <sub>VAC_HIZ</sub>	Input supply current (VAC) in buck mode	V <sub>VAC</sub> = 5 V, HIZ Mode and OVPFET_DIS = 1, No battery	24	37	μA
		V <sub>VAC</sub> = 12 V, HIZ Mode and OVPFET_DIS = 1, No battery	41	61	μA
I <sub>VACVBUS_HIZ</sub>	Input supply current (VAC and VBUS short) in buck mode	V <sub>VAC</sub> = 5 V, HIZ Mode and OVPFET_DIS = 1, No battery	37	50	μA
		V <sub>VAC</sub> = 12 V, HIZ Mode and OVPFET_DIS = 1, No battery	68	90	μA
I <sub>VBUS</sub>	Input supply current (VBUS) in buck mode	V <sub>VBUS</sub> = 12 V, V <sub>VBUS</sub> > V <sub>VBAT</sub> , converter not switching	1.5	3	mA
		V <sub>VBUS</sub> > V <sub>VUVO</sub> , V <sub>VBUS</sub> > V <sub>VBAT</sub> , converter switching, V <sub>BAT</sub> = 3.8V, I <sub>SYS</sub> = 0A	3		mA
I <sub>BOOST</sub>	Battery discharge current in boost mode	V <sub>BAT</sub> = 4.2 V, boost mode, I <sub>VBUS</sub> = 0 A, converter switching	3		mA
<b>VBUS, VAC AND BAT PIN POWER-UP</b>					

## 7.5 Electrical Characteristics (continued)

$V_{VAC\_UVLOZ} < V_{VAC} < V_{VAC\_OV}$  and  $V_{VAC} > V_{BAT} + V_{SLEEP}$ ,  $T_J = -40^{\circ}\text{C}$  to  $125^{\circ}\text{C}$  and  $T_J = 25^{\circ}\text{C}$  for typical values (unless otherwise noted)

PARAMETER	TEST CONDITIONS	MIN	TYP	MAX	UNIT	
$V_{BUS\_OP}$	VBUS operating range	$V_{VBUS}$ rising	3.9	13.5	V	
$V_{VAC\_UVLOZ}$	VAC for active I <sup>2</sup> C, no battery Sense VAC pin voltage	$V_{VAC}$ rising	3.3	3.7	V	
$V_{VAC\_UVLOZ\_HYS}$	I <sup>2</sup> C active hysteresis	$V_{AC}$ falling from above $V_{VAC\_UVLOZ}$	300		mV	
$V_{VAC\_PRESENT}$	REGN turn-on threshold	$V_{VAC}$ rising	3.65	3.9	V	
$V_{VAC\_PRESENT\_HYS}$		$V_{VAC}$ falling	500		mV	
$V_{SLEEP}$	Sleep mode falling threshold	$(V_{VAC} - V_{VBAT}), V_{BUSMIN\_FALL} \leq V_{BAT} \leq V_{REG}, V_{AC}$ falling	15	60	131	mV
$V_{SLEEPZ}$	Sleep mode rising threshold	$(V_{VAC} - V_{VBAT}), V_{BUSMIN\_FALL} \leq V_{BAT} \leq V_{REG}, V_{AC}$ rising	115	220	340	mV
$V_{VAC\_OV\_RISE}$	VAC 6.5-V Overvoltage rising threshold	VAC rising; OVP (REG06[7:6]) = '01'	6.1	6.42	6.75	V
$V_{VAC\_OV\_RISE}$	VAC 10.5-V Overvoltage rising threshold	VAC rising, OVP (REG06[7:6]) = '10'	10.35	11	11.5	V
$V_{VAC\_OV\_RISE}$	VAC 14-V Overvoltage rising threshold	VAC rising, OVP (REG06[7:6]) = '11'	13.5	14.2	15	V
$V_{VAC\_OV\_HYS}$	VAC 6.5-V Overvoltage hysteresis	VAC falling, OVP (REG06[7:6]) = '01'	130			mV
$V_{VAC\_OV\_HYS}$	VAC 10.5-V Overvoltage hysteresis	VAC falling, OVP (REG06[7:6]) = '10'	250			mV
$V_{VAC\_OV\_HYS}$	VAC 14-V Overvoltage hysteresis	VAC falling, OVP (REG06[7:6]) = '11'	300			mV
$V_{BAT\_UVLOZ}$	BAT for active I <sup>2</sup> C, no adapter	$V_{BAT}$ rising	2.5			V
$V_{BAT\_DPL\_FALL}$	Battery Depletion Threshold	$V_{BAT}$ falling	2.18		2.62	V
$V_{BAT\_DPL\_RISE}$	Battery Depletion Threshold	$V_{BAT}$ rising	2.34		2.86	V
$V_{BAT\_DPL\_HYST}$	Battery Depletion rising hysteresis	$V_{BAT}$ rising		180		mV
$V_{BUSMIN\_FALL}$	Bad adapter detection falling threshold	$V_{BUS}$ falling	3.68	3.8	3.9	V
$V_{BUSMIN\_HYST}$	Bad adapter detection hysteresis			180		mV
$I_{BADSRC}$	Bad adapter detection current source	Sink current from VBUS to GND		30		mA
<b>POWER-PATH</b>						
$V_{SYS\_MIN}$	System regulation voltage	$V_{VBAT} < SYS\_MIN[2:0] = 101$ , BATFET Disabled (REG07[5] = 1)	3.5	3.68		V
$V_{SYS}$	System Regulation Voltage	$I_{SYS} = 0\text{ A}$ , $V_{VBAT} > V_{SYSMIN}$ , $V_{VBAT} = 4.400\text{ V}$ , BATFET disabled (REG07[5] = 1)		$V_{BAT} + 50\text{ mV}$		V
$V_{SYS\_MAX}$	Maximum DC system voltage output	$I_{SYS} = 0\text{ A}$ , Q4 off, $V_{VBAT} \leq 4.400\text{ V}$ , $V_{VBAT} > V_{SYSMIN} = 3.5\text{ V}$	4.4	4.45	4.48	V
$R_{ON(RBFET)}$	Top reverse blocking MOSFET on-resistance between VBUS and PMID - Q1	$-40^{\circ}\text{C} \leq T_A \leq 125^{\circ}\text{C}$		35		m $\Omega$
$R_{ON(HSFET)}$	Top switching MOSFET on-resistance between PMID and SW - Q2	$V_{REGN} = 5\text{ V}$ , $-40^{\circ}\text{C} \leq T_A \leq 125^{\circ}\text{C}$		55		m $\Omega$
$R_{ON(LSFET)}$	Bottom switching MOSFET on-resistance between SW and GND - Q3	$V_{REGN} = 5\text{ V}$ , $-40^{\circ}\text{C} \leq T_A \leq 125^{\circ}\text{C}$		60		m $\Omega$
$V_{FWD}$	BATFET forward voltage in supplement mode			30		mV

## 7.5 Electrical Characteristics (continued)

$V_{VAC\_UVLOZ} < V_{VAC} < V_{VAC\_OV}$  and  $V_{VAC} > V_{BAT} + V_{SLEEP}$ ,  $T_J = -40^{\circ}\text{C}$  to  $125^{\circ}\text{C}$  and  $T_J = 25^{\circ}\text{C}$  for typical values (unless otherwise noted)

PARAMETER		TEST CONDITIONS	MIN	TYP	MAX	UNIT
$R_{ON(BAT-SYS)}$	SYS-BAT MOSFET on-resistance	QFN package, Measured from BAT to SYS, $V_{BAT} = 4.2\text{V}$ , $T_J = -40 - 125^{\circ}\text{C}$		19.5		$\text{m}\Omega$
<b>BATTERY CHARGER</b>						
$V_{BATREG\_RANGE}$	Charge voltage program range		3.856		4.624	V
$V_{BATREG\_STEP}$	Charge voltage step			32		mV
$V_{BATREG}$	Charge voltage setting	$V_{REG}(\text{REG04}[7:3]) = 4.208\text{V}$ (01011), V, $-40 \leq T_J \leq 85^{\circ}\text{C}$	4.187	4.208	4.229	V
		$V_{REG}(\text{REG04}[7:3]) = 4.352\text{V}$ (01111), V, $-40 \leq T_J \leq 85^{\circ}\text{C}$	4.330	4.352	4.374	V
$V_{BATREG\_ACC}$	Charge voltage setting accuracy	$V_{BAT} = 4.208\text{V}$ or $V_{BAT} = 4.352\text{V}$ , $-40 \leq T_J \leq 85^{\circ}\text{C}$	-0.5%		0.5%	
$I_{CHG\_REG\_RANGE}$	Charge current regulation range		0		3000	mA
$I_{CHG\_REG\_STEP}$	Charge current regulation step			60		mA
$I_{CHG\_REG}$	Charge current regulation setting	$I_{CHG} = 240\text{mA}$ , $V_{VBAT} = 3.1\text{V}$ or $V_{VBAT} = 3.8\text{V}$	0.214	0.24	0.26	A
$I_{CHG\_REG\_ACC}$	Charge current regulation accuracy	$I_{CHG} = 240\text{mA}$ , $V_{VBAT} = 3.1\text{V}$ or $V_{VBAT} = 3.8\text{V}$	-11%		9%	
$I_{CHG\_REG}$	Charge current regulation setting	$I_{CHG} = 720\text{mA}$ , $V_{VBAT} = 3.1\text{V}$ or $V_{VBAT} = 3.8\text{V}$	0.68	0.720	0.76	A
$I_{CHG\_REG}$	Charge current regulation accuracy	$I_{CHG\_REG} = 720\text{mA}$ , $V_{BAT} = 3.1\text{V}$ or $V_{BAT} = 3.8\text{V}$	-6%		6%	
$I_{CHG\_REG}$	Charge current regulation setting	$I_{CHG} = 1.38\text{A}$ , $V_{VBAT} = 3.1\text{V}$ or $V_{VBAT} = 3.8\text{V}$	1.30	1.380	1.45	A
$I_{CHG\_REG\_ACC}$	Charge current regulation accuracy	$I_{CHG} = 720\text{mA}$ or $I_{CHG} = 1.38\text{A}$ , $V_{VBAT} = 3.1\text{V}$ or $V_{VBAT} = 3.8\text{V}$	-6%		6%	
$V_{BATLOWV\_FALL}$	Battery LOWV falling threshold	$I_{CHG} = 240\text{mA}$	2.7	2.8	2.9	V
$V_{BATLOWV\_RISE}$	Battery LOWV rising threshold	Pre-charge to fast charge	3	3.12	3.24	V
$I_{PRECHG}$	Precharge current regulation	$I_{PRECHG}[3:0] = '0010' = 180\text{mA}$	150	170	190	mA
$I_{PRECHG\_ACC}$	Precharge current regulation accuracy	$I_{PRECHG}[3:0] = '0010' = 180\text{mA}$	-15		5	%
$I_{TERM}$	Termination current regulation	$I_{CHG} > 780\text{mA}$ , $I_{TERM}[3:0] = '0010' = 180\text{mA}$ , $V_{VBAT} = 4.208\text{V}$	145	180	215	mA
$I_{TERM\_ACC}$	Termination current regulation accuracy	$I_{CHG} > 780\text{mA}$ , $I_{TERM}[3:0] = '0010' = 180\text{mA}$ , $V_{VBAT} = 4.208\text{V}$	-20%		20%	
$I_{TERM}$	Termination current regulation	$I_{CHG} \leq 780\text{mA}$ , $I_{TERM}[3:0] = '0000' = 60\text{mA}$ , $V_{VBAT} = 4.208\text{V}$	44	60	75	mA
$I_{TERM\_ACC}$	Termination current regulation accuracy	$I_{CHG} \leq 780\text{mA}$ , $I_{TERM}[3:0] = '0000' = 60\text{mA}$ , $V_{VBAT} = 4.208\text{V}$	-27%		25%	
$V_{SHORT}$	Battery short voltage	$V_{VBAT}$ falling	1.85	2	2.15	V
$V_{SHORTZ}$	Battery short voltage	$V_{VBAT}$ rising	2.15	2.25	2.35	V
$I_{SHORT}$	Battery short current	$V_{VBAT} < V_{SHORTZ}$	50	90	117	mA
$V_{RECHG}$	Recharge Threshold below $V_{BAT\_REG}$	$V_{BAT}$ falling, $\text{REG04}[0] = 0$	90	120	150	mV
$V_{RECHG}$	Recharge Threshold below $V_{BAT\_REG}$	$V_{BAT}$ falling, $\text{REG04}[0] = 1$	200	230	265	mV
$I_{SYSLOAD}$	System discharge load current	$V_{SYS} = 4.2\text{V}$		30		mA
<b>INPUT VOLTAGE AND CURRENT REGULATION</b>						
$V_{INDPM}$	Input voltage regulation limit	$V_{INDPM}(\text{REG06}[3:0] = 0000) = 3.9\text{V}$	3.78	3.95	4.1	V

## 7.5 Electrical Characteristics (continued)

$V_{VAC\_UVLOZ} < V_{VAC} < V_{VAC\_OV}$  and  $V_{VAC} > V_{BAT} + V_{SLEEP}$ ,  $T_J = -40^{\circ}\text{C}$  to  $125^{\circ}\text{C}$  and  $T_J = 25^{\circ}\text{C}$  for typical values (unless otherwise noted)

PARAMETER	TEST CONDITIONS	MIN	TYP	MAX	UNIT		
$V_{INDPM\_ACC}$	Input voltage regulation accuracy	$V_{INDPM} (REG06[3:0] = 0000) = 3.9\text{ V}$		- 4.5%	4%		
$V_{INDPM}$	Input voltage regulation limit	$V_{INDPM} (REG06[3:0] = 0110) = 4.4\text{ V}$		4.268	4.4	4.532	V
$V_{INDPM\_ACC}$	Input voltage regulation accuracy	$V_{INDPM} (REG06[3:0] = 0110) = 4.4\text{ V}$		- 3%	3%		
$V_{DPM\_VBAT}$	Input voltage regulation limit tracking VBAT	$V_{INDPM} = 3.9\text{V}$ , $V_{DPM\_VBAT\_TRACK} = 300\text{mV}$ , $V_{BAT} = 4.0\text{V}$		4.17	4.3	4.46	V
$V_{DPM\_VBAT\_ACC}$	Input voltage regulation accuracy tracking VBAT	$V_{INDPM} = 3.9\text{V}$ , $V_{DPM\_VBAT\_TRACK} = 300\text{mV}$ , $V_{BAT} = 4.0\text{V}$		- 3%		4%	
$I_{INDPM}$	USB input current regulation limit	$V_{VBUS} = 5\text{ V}$ , current pulled from SW, $I_{INDPM} (REG[4:0] = 00100) = 500\text{ mA}$ , $-40 \leq T_J \leq 85^{\circ}\text{C}$		450		500	mA
		$V_{VBUS} = 5\text{ V}$ , current pulled from SW, $I_{INDPM} (REG[4:0] = 01000) = 900\text{ mA}$ , $-40 \leq T_J \leq 85^{\circ}\text{C}$		750		900	mA
		$V_{VBUS} = 5\text{ V}$ , current pulled from SW, $I_{INDPM} (REG[4:0] = 01110) = 1.5\text{ A}$ , $-40 \leq T_J \leq 85^{\circ}\text{C}$		1.28		1.5	A
$I_{IN\_START}$	Input current limit during system start-up sequence		200			mA	
<b>BAT PIN OVERVOLTAGE PROTECTION</b>							
$V_{BATOVP\_RISE}$	Battery overvoltage threshold	$V_{BAT}$ rising, as percentage of $V_{BAT\_REG}$		103	104	105	%
$V_{BATOVP\_Fall\_HYS}$	Battery overvoltage falling hysteresis	$V_{BAT}$ falling, as percentage of $V_{BAT\_REG}$			2		%
<b>THERMAL REGULATION AND THERMAL SHUTDOWN</b>							
$T_{JUNCTION\_REG}$	Junction Temperature Regulation Threshold	Temperature Increasing, TREG (REG05[1] = 1) = $110^{\circ}\text{C}$			110		$^{\circ}\text{C}$
$T_{JUNCTION\_REG}$	Junction Temperature Regulation Threshold	Temperature Increasing, TREG (REG05[1] = 0) = $90^{\circ}\text{C}$			90		$^{\circ}\text{C}$
$T_{SHUT}$	Thermal Shutdown Rising Temperature	Temperature Increasing			160		$^{\circ}\text{C}$
$T_{SHUT\_HYST}$	Thermal Shutdown Hysteresis				30		$^{\circ}\text{C}$
<b>JEITA THERMISTOR COMPARATOR (BUCK MODE)</b>							
$V_{T1}$	T1 ( $0^{\circ}\text{C}$ ) threshold, Charge suspended T1 below this temperature.	Charger suspends charge. As Percentage to $V_{REGN}$ .		72.4%	73.3%	74.2%	
$V_{T1}$	Falling	As Percentage to $V_{REGN}$		69%	71.5%	74%	
$V_{T2}$	T2 ( $10^{\circ}\text{C}$ ) threshold, Charge back to $I_{CHG}/2$ and 4.2 V below this temperature	As percentage of $V_{REGN}$		67.2%	68%	69%	
$V_{T2}$	Falling	As Percentage to $V_{REGN}$		66%	66.8%	67.7%	
$V_{T3}$	T3 ( $45^{\circ}\text{C}$ ) threshold, charge back to $I_{CHG}$ and 4.05V above this temperature.	Charger suspends charge. As Percentage to $V_{REGN}$		43.8%	44.7%	45.8%	
$V_{T3}$	Falling	As Percentage to $V_{REGN}$		45.1%	45.7%	46.2%	
$V_{T5}$	T5 ( $60^{\circ}\text{C}$ ) threshold, charge suspended above this temperature.	As Percentage to $V_{REGN}$		33.7%	34.2%	35.1%	
$V_{T5}$	Falling	As Percentage to $V_{REGN}$		34.5%	35.3%	36.2%	
<b>COLD OR HOT THERMISTOR COMPARATOR (BOOST MODE)</b>							

## 7.5 Electrical Characteristics (continued)

$V_{VAC\_UVLOZ} < V_{VAC} < V_{VAC\_OV}$  and  $V_{VAC} > V_{BAT} + V_{SLEEP}$ ,  $T_J = -40^{\circ}\text{C}$  to  $125^{\circ}\text{C}$  and  $T_J = 25^{\circ}\text{C}$  for typical values (unless otherwise noted)

PARAMETER		TEST CONDITIONS	MIN	TYP	MAX	UNIT
$V_{BCOLD}$	Cold Temperature Threshold, TS pin Voltage Rising Threshold	As Percentage to $V_{REGN}$ (Approx. $-20^{\circ}\text{C}$ w/ 103AT), $T_J = -20^{\circ}\text{C} - 125^{\circ}\text{C}$	79.5%	80%	80.5%	
$V_{BCOLD}$	Falling	$T_J = -20^{\circ}\text{C} - 125^{\circ}\text{C}$	78.5%	79%	79.5%	
$V_{BHOT}$	Hot Temperature Threshold, TS pin Voltage falling Threshold	As Percentage to $V_{REGN}$ (Approx. $60^{\circ}\text{C}$ w/ 103AT), $T_J = -20^{\circ}\text{C} - 125^{\circ}\text{C}$	30.2%	31.2%	32.2%	
$V_{BHOT}$	Rising	$T_J = -20^{\circ}\text{C} - 125^{\circ}\text{C}$	33.8%	34.4%	34.9%	
<b>CHARGE OVERCURRENT COMPARATOR (CYCLE-BY-CYCLE)</b>						
$I_{BATFET\_OCP}$	System over load threshold		6.0			A
<b>PWM</b>						
$f_{SW}$	PWM switching frequency	Oscillator frequency, buck mode	1320	1500	1680	kHz
		Oscillator frequency, boost mode	1150	1412	1660	kHz
$D_{MAX}$	Maximum PWM duty cycle <sup>(1)</sup>			97%		
<b>BOOST MODE OPERATION</b>						
$V_{OTG\_REG}$	Boost mode regulation voltage	$V_{BAT} = 3.8\text{ V}$ , $I_{(PMID)} = 0\text{ A}$ , $BOOSTV[1:0] = '10' = 5.15\text{ V}$	4.972	5.126	5.280	V
$V_{OTG\_REG\_ACC}$	Boost mode regulation voltage accuracy	$V_{BAT} = 3.8\text{ V}$ , $I_{(PMID)} = 0\text{ A}$ , $BOOSTV[1:0] = '10' = 5.15\text{ V}$	-3		3	%
$V_{BATLOWV\_OTG}$	Battery voltage exiting boost mode	$V_{BAT}$ falling, $MIN\_V_{BAT\_SEL}$ (REG01[0]) = 0	2.6	2.8	2.9	V
		$V_{BAT}$ rising, $MIN\_V_{BAT\_SEL}$ (REG01[0]) = 0	2.9	3.0	3.15	V
		$V_{BAT}$ falling, $MIN\_V_{BAT\_SEL}$ (REG01[0]) = 1	2.4	2.5	2.6	V
		$V_{BAT}$ rising, $MIN\_V_{BAT\_SEL}$ (REG01[0]) = 1	2.7	2.8	2.9	V
$I_{OTG}$	OTG mode output current	$BOOST\_LIM$ (REG02[7]) = 1	1.16	1.4	1.6	A
$I_{OTG\_OCP\_ACC}$	Boost mode RBFET over-current protection accuracy	$BOOST\_LIM = 0.5\text{ A}$ (REG02[7] = 0)	0.5		0.73	A
$V_{OTG\_OVP}$	OTG overvoltage threshold	Rising threshold	5.55	5.8	6.15	V
$I_{OTG\_HSZCP}$	HSFET under current falling threshold			100		mA
<b>REGN LDO</b>						
$V_{REGN}$	REGN LDO output voltage	$V_{VBUS} = 9\text{V}$ , $I_{REGN} = 40\text{mA}$	5.6	6		V
$V_{REGN}$	REGN LDO output voltage	$V_{VBUS} = 5\text{V}$ , $I_{REGN} = 20\text{mA}$	4.58	4.7		V
<b>LOGIC I/O PIN CHARACTERISTICS ( <math>\overline{CE}</math>, PSEL, SCL, SDA,, INT)</b>						
$V_{ILO}$	Input low threshold $\overline{CE}$				0.4	V
$V_{IH}$	Input high threshold $\overline{CE}$		1.3			V
$I_{BIAS}$	High-level leakage current $\overline{CE}$	Pull up rail 1.8 V			1	$\mu\text{A}$
$V_{ILO}$	Input low threshold PSEL				0.4	V
$V_{IH}$	Input high threshold PSEL		1.3			V
$I_{BIAS}$	High-level leakage current PSEL	Pull up rail 1.8V			1	$\mu\text{A}$
<b>LOGIC I/O PIN CHARACTERISTICS ( PG, STAT)</b>						
$V_{OL}$	Low-level output voltage				0.4	V
<b>D+/D - DETECTION</b>						

## 7.5 Electrical Characteristics (continued)

$V_{VAC\_UVLOZ} < V_{VAC} < V_{VAC\_OV}$  and  $V_{VAC} > V_{BAT} + V_{SLEEP}$ ,  $T_J = -40^{\circ}\text{C}$  to  $125^{\circ}\text{C}$  and  $T_J = 25^{\circ}\text{C}$  for typical values (unless otherwise noted)

PARAMETER		TEST CONDITIONS	MIN	TYP	MAX	UNIT
$V_{D+\_1P2}$	D+ Threshold for Non-standard adapter (combined V1P2_VTH_LO and V1P2_VTH_HI)		1.05		1.35	V
$I_{D+\_LKG}$	Leakage current into D+	HiZ	-1		1	$\mu\text{A}$
$V_{D-\_600MVSRC}$	Voltage source (600 mV)		500	600	700	mV
$I_{D-\_100UAISNK}$	D - current sink (100 $\mu\text{A}$ )	$V_{D-} = 500$ mV,	50	100	150	$\mu\text{A}$
$R_{D-\_19K}$	D - resistor to ground (19 k $\Omega$ )	$V_{D-} = 500$ mV,	14.25		24.8	k $\Omega$
$V_{D-\_0P325}$	D - comparator threshold for primary detection	D - pin Rising	250		400	mV
$V_{D-\_2P8}$	D - Threshold for non-standard adapter (combined V2P8_VTH_LO and V2P8_VTH_HI)		2.55		2.85	V
$V_{D-\_2P0}$	D - Comparator threshold for non-standard adapter (For non-standard - same as bq2589x)		1.85		2.15	V
$V_{D-\_1P2}$	D - Threshold for non-standard adapter (combined V1P2_VTH_LO and V1P2_VTH_HI)		1.05		1.35	V
$I_{D-\_LKG}$	Leakage current into D -	HiZ	-1		1	$\mu\text{A}$

(1) Specified by design. Not production tested.

## 7.6 Timing Requirements

			MIN	NOM	MAX	UNIT
<b>VBUS/BAT POWER UP</b>						
$t_{ACOV}$	VAC OVP reaction time	VAC rising above ACOV threshold to turn off Q2		200		ns
$t_{BADSRC}$	Bad adapter detection duration			30		ms
<b>BATTERY CHARGER</b>						
$t_{TERM\_DGL}$	Deglitch time for charge termination			250		ms
$t_{RECHG\_DGL}$	Deglitch time for recharge			250		ms
$t_{SYSOVLD\_DGL}$	System over-current deglitch time to turn off Q4			100		$\mu\text{s}$
$t_{BATOVP}$	Battery over-voltage deglitch time to disable charge			1		$\mu\text{s}$
$t_{SAFETY}$	Typical Charge Safety Timer Range	CHG_TIMER = 1	8	10	12	hr
$t_{TOP\_OFF}$	Typical Top-Off Timer Range	TOP_OFF_TIMER[1:0] = 10 (30 min)	24	30	36	min
<b>QON TIMING</b>						
$t_{SHIPMODE}$	/QON low time to turn on BATFET and exit ship mode	$-10^{\circ}\text{C} \leq T_J \leq 60^{\circ}\text{C}$	0.9		1.3	s
$t_{QON\_RST\_2}$	QON low time to reset BATFET	$-10^{\circ}\text{C} \leq T_J \leq 60^{\circ}\text{C}$	8		12	s
$t_{BATFET\_RST}$	BATFET off time during full system reset	$-10^{\circ}\text{C} \leq T_J \leq 60^{\circ}\text{C}$	250		400	ms
$t_{SM\_DLY}$	Enter ship mode delay	$-10^{\circ}\text{C} \leq T_J \leq 60^{\circ}\text{C}$	10		15	s
<b>DIGITAL CLOCK AND WATCHDOG TIMER</b>						
$t_{WDT}$	REG05[4]=1	REGN LDO disabled		40		s
$f_{LPDIG}$	Digital Low Power Clock	REGN LDO disabled		30		kHz
$f_{DIG}$	Digital Clock	REGN LDO enabled		500		kHz

		MIN	NOM	MAX	UNIT
f <sub>SCL</sub>	SCL clock frequency			400	kHz

### 7.7 Typical Characteristics

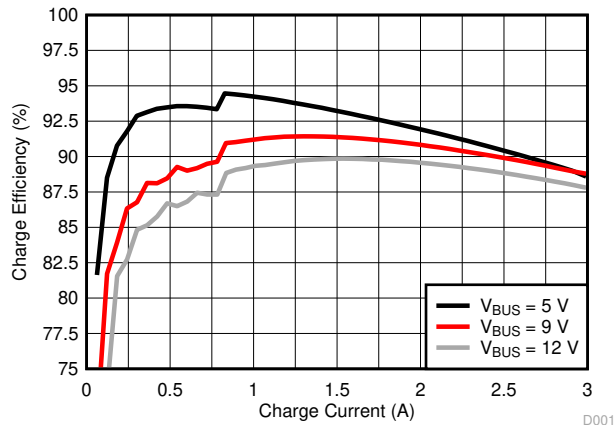

$f_{SW} = 1.5 \text{ MHz}$  inductor DCR =  $18 \text{ m}\Omega$   
 $V_{BAT} = 3.8 \text{ V}$

图 7-1. Charge Efficiency vs. Charge Current

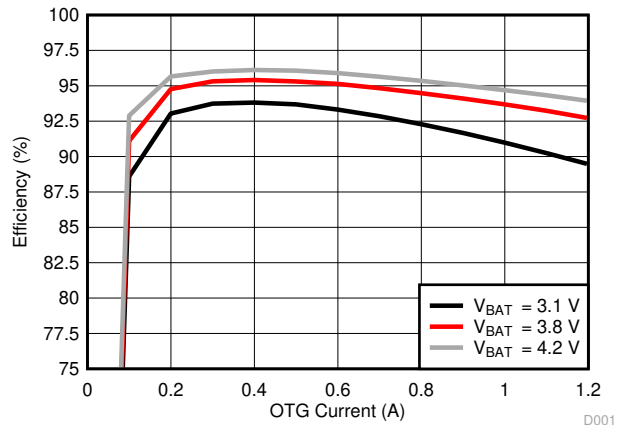

$V_{OTG} = 5.15 \text{ V}$  inductor DCR =  $18 \text{ m}\Omega$

图 7-2. Efficiency vs. OTG Current

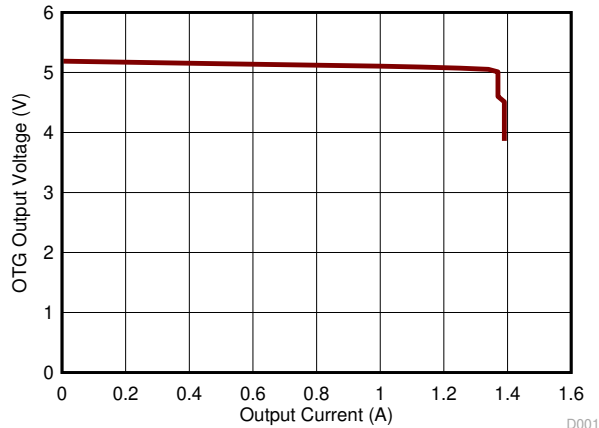

$I_{OTG} = 1.2 \text{ A}$   $V_{OTG} = 5.15 \text{ V}$   
 $V_{VBAT} = 3.8 \text{ V}$

图 7-3. OTG Output Voltage vs. Output Current



图 7-4. Charge Current Accuracy



图 7-5. SYSMIN Voltage vs. Junction Temperature

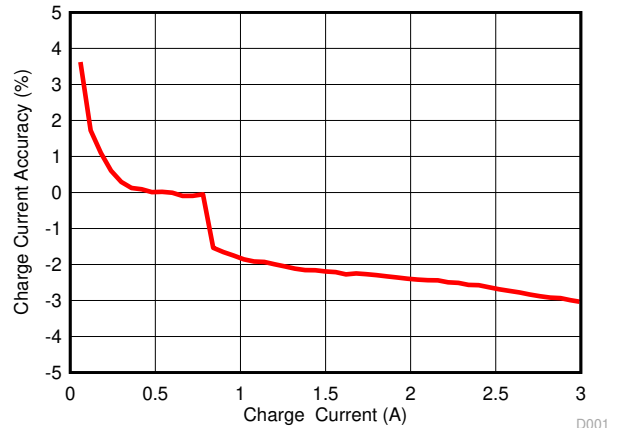

图 7-6. BATREG Charge Voltage vs. Junction Temperature



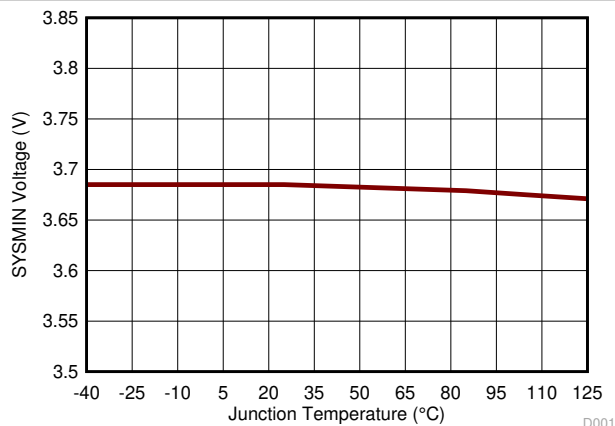

图 7-7. Input Current Limit vs. Junction Temperature

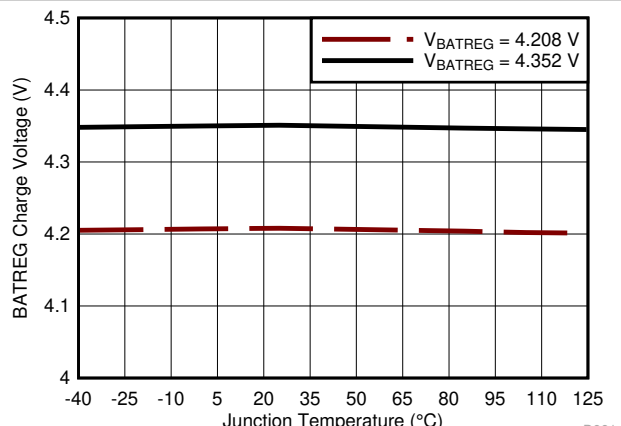

图 7-8. Charge Current vs. Junction Temperature

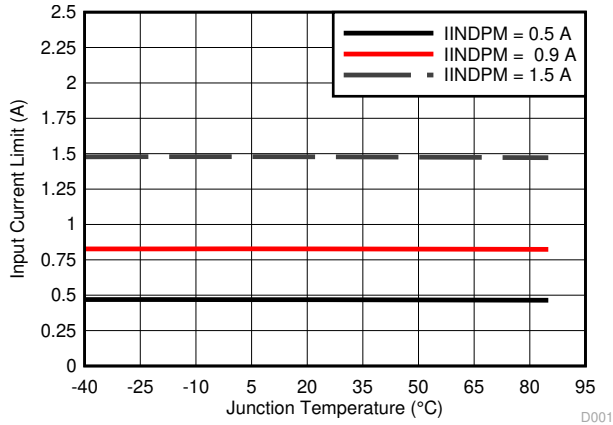

图 7-9. Charge Current vs. Junction Temperature Under Thermal Regulation

## 8 Detailed Description

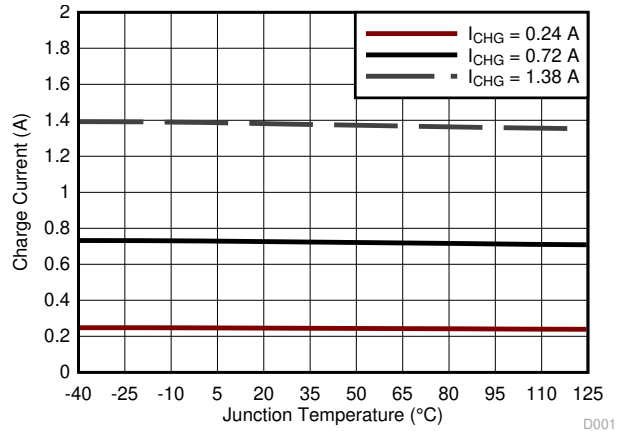
### 8.1 Overview

The BQ25600 and BQ25600D is a highly integrated 3.0-A switch-mode battery charger for single cell Li-ion and Li-polymer batteries. It includes an input reverse-blocking FET (RBFET, Q1), high-side switching FET (HSFET, Q2), low-side switching FET (LSFET, Q3), and battery FET (BATFET, Q4), and bootstrap diode for the high-side gate drive.

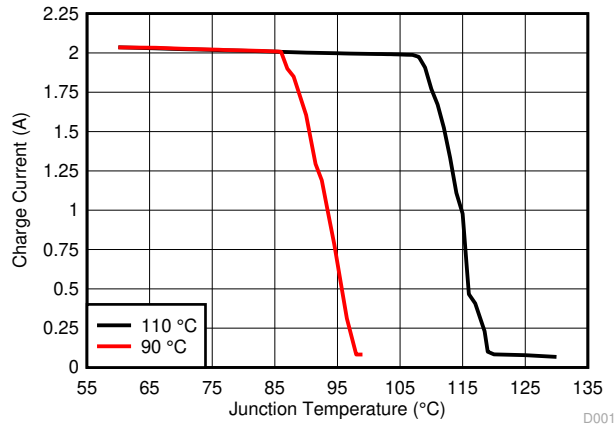
## 8.2 Functional Block Diagram

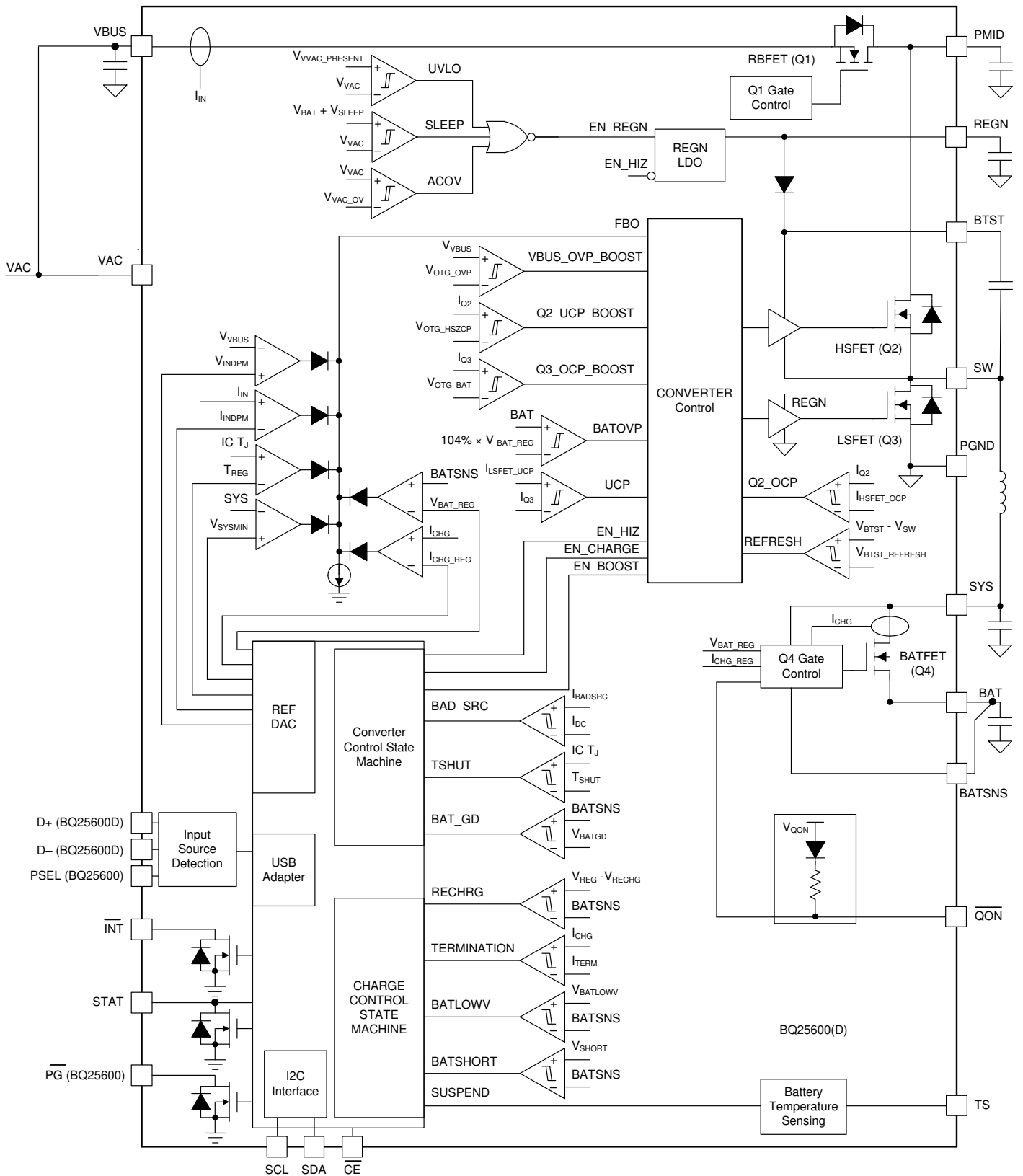

## 8.3 Feature Description

### 8.3.1 Power-On-Reset (POR)

The device powers internal bias circuits from the higher voltage of VBUS and BAT. When VBUS rises above  $V_{VBUS\_UVLOZ}$  or BAT rises above  $V_{BAT\_UVLOZ}$ , the sleep comparator, battery depletion comparator and BATFET driver are active. I<sup>2</sup>C interface is ready for communication and all the registers are reset to default value. The host can access all the registers after POR.

### 8.3.2 Device Power Up from Battery without Input Source

If only battery is present and the voltage is above depletion threshold ( $V_{BAT\_DPL\_RISE}$ ), the BATFET turns on and connects battery to system. The REGN stays off to minimize the quiescent current. The low RDSON of BATFET and the low quiescent current on BAT minimize the conduction loss and maximize the battery run time.

The device always monitors the discharge current through BATFET (Supplement Mode). When the system is overloaded or shorted ( $I_{BAT} > I_{BATFET\_OCP}$ ), the device turns off BATFET immediately and set BATFET\_DIS bit to indicate BATFET is disabled until the input source plugs in again or one of the methods described in BATFET Enable (Exit Shipping Mode) is applied to re-enable BATFET.

### 8.3.3 Power Up from Input Source

When an input source is plugged in, the device checks the input source voltage to turn on REGN LDO and all the bias circuits. It detects and sets the input current limit before the buck converter is started. The power-up sequence from input source is as listed:

1. Power up REGN LDO
2. Poor source qualification
3. Input source type detection is based on D+/D- or PSEL to set default input current limit (IINDPM) register or input source type.
4. Input voltage limit threshold setting (VINDPM threshold)
5. Converter power up

#### 8.3.3.1 Power Up REGN Regulation

The REGN LDO supplies internal bias circuits as well as the HSFET and LSFET gate drive. The REGN also provides bias rail to TS external resistors. The pull-up rail of STAT can be connected to REGN as well. The REGN is enabled when all the below conditions are valid:

- $V_{VAC}$  above  $V_{VAC\_PRESENT}$
- $V_{VAC}$  above  $V_{BAT} + V_{SLEEPZ}$  in buck mode or  $V_{BUS}$  below  $V_{BAT} + V_{SLEEP}$  in boost mode
- After 220-ms delay is completed

If any one of the above conditions is not valid, the device is in high impedance mode (HIZ) with REGN LDO off. The device draws less than  $I_{VBUS\_HIZ}$  from VBUS during HIZ state. The battery powers up the system when the device is in HIZ.

#### 8.3.3.2 Poor Source Qualification

After REGN LDO powers up, the device confirms the current capability of the input source. The input source must meet both of the following requirements in order to start the buck converter.

- VAC voltage below  $V_{VAC\_OV}$
- VBUS voltage above  $V_{VBUSMIN}$  when pulling  $I_{BADSRC}$  (typical 30 mA)

Once the input source passes all the conditions above, the status register bit VBUS\_GD is set high and the  $\overline{INT}$  pin is pulsed to signal to the host. If the device fails the poor source detection, it repeats poor source qualification every 2 seconds.

#### 8.3.3.3 Input Source Type Detection

After the VBUS\_GD bit is set and REGN LDO is powered, the device runs input source detection through D+/D- lines or the PSEL pin. The BQ25600D follows the USB Battery Charging Specification 1.2 (BC1.2) to

detect input source (SDP/ DCP) and nonstandard adapter through USB D+/D - lines. The BQ25600 sets input current limit through PSEL pins.

After input source type detection is completed, an INT pulse is asserted to the host. in addition, the following registers and pin are changed:

1. Input Current Limit (IINDPM) register is changed to set current limit
2. PG\_STAT bit is set
3. VBUS\_STAT bit is updated to indicate USB or other input source

The host can overwrite IINDPM register to change the input current limit if needed. The charger input current is always limited by the IINDPM register.

### 8.3.3.3.1 D+/D - Detection Sets Input Current Limit in BQ25600D

The BQ25600D contains a D+/D - based input source detection to set the input current limit at VBUS plug-in. The D+/D - detection includes standard USB BC1.2 and nonstandard adapter. When input source is plugged in, the device starts standard USB BC1.2 detections. The USB BC1.2 is capable to identify Standard Downstream Port (SDP) and Dedicated Charging Port (DCP). When the Data Contact Detection (DCD) timer expires, the nonstandard adapter detection is applied to set the input current limit. The nonstandard detection is used to distinguish vendor specific adapters (Apple and Samsung) based on their unique dividers on the D+/D - pins. If an adapter is detected as DCP, the input current limit is set at 2.4 A. If an adapter is detected as unknown, the input current limit is set at 500 mA

**表 8-1. Nonstandard Adapter Detection**

NONSTANDARD ADAPTER	D+ THRESHOLD	D - THRESHOLD	INPUT CURRENT LIMIT (A)
Divider 1	$V_{D+}$ within $V_{D+\_2p8}$	$V_{D-}$ within $V_{D-\_2p0}$	2.1
Divider 2	$V_{D+}$ within $V_{D+\_1p2}$	$V_{D-}$ within $V_{D-\_1p2}$	2
Divider 3	$V_{D+}$ within $V_{D+\_2p0}$	$V_{D-}$ within $V_{D-\_2p8}$	1
Divider 4	$V_{D+}$ within $V_{D+\_2p8}$	$V_{D-}$ within $V_{D-\_2p8}$	2.4

**表 8-2. Input Current Limit Setting from D+/D - Detection**

D+/D - DETECTION	INPUT CURRENT LIMIT (IILIM)
USB SDP (USB500)	500 mA
USB DCP	2.4 A
Divider 3	1 A
Divider 1	2.1 A
Divider 4	2.4 A
Divider 2	2 A
Unknown 5-V adapter	500 mA

### 8.3.3.3.2 PSEL Pins Sets Input Current Limit in BQ25600

The BQ25600 has PSEL pin for input current limit setting to interface with USB PHY. It directly takes the USB PHY device output to decide whether the input is USB host or charging port. When the device operates in host-control mode, the host needs to IINDET\_EN bit to read the PSEL value and update the IINDPM register. When the device is in default mode, PSEL value updates IINDPM in real time.

**表 8-3. Input Current Limit Setting from PSEL**

INPUT DETECTION	PSEL PIN	INPUT CURRENT LIMIT (IILIM)	VBUS_STAT
USB SDP	High	500 mA	001
Adapter	Low	2.4A	011

### 8.3.3.4 Input Voltage Limit Threshold Setting (VINDPM Threshold)

The device supports wide range of input voltage limit (3.9 V to 5.4 V) for USB. The device VINDPM is set at 4.5 V. The device supports dynamic VINDPM tracking settings which tracks the battery voltage. This function can be enabled via the VDPM\_BAT\_TRACK[1:0] register bits. When enabled, the actual input voltage limit will be the higher of the VINDPM register and VBAT + VDPM\_BAT\_TRACK offset.

### 8.3.3.5 Converter Power Up

After the input current limit is set, the converter is enabled and the HSFET and LSFET start switching. If battery charging is disabled, BATFET turns off. Otherwise, BATFET stays on to charge the battery.

The device provides soft start when system rail is ramped up. When the system rail is below 2.2 V, the input current is limited to is to the lower of 200 mA or IINDPM register setting. After the system rises above 2.2 V, the device limits input current to the value set by IINDPM register.

As a battery charger, the device deploys a highly efficient 1.5 MHz step-down switching regulator. The fixed frequency oscillator keeps tight control of the switching frequency under all conditions of input voltage, battery voltage, charge current and temperature, simplifying output filter design.

The device switches to PFM control at light load or when battery is below minimum system voltage setting or charging is disabled. The PFM\_DIS bit can be used to prevent PFM operation in either buck or boost configuration. PFM mod is only enabled when IINDPM is set  $\geq$  500 mA. When IINDPM is set  $\leq$  400 mA, PFM mode is disabled.

### 8.3.4 Boost Mode Operation From Battery

The device supports boost converter operation to deliver power from the battery to other portable devices through USB port. The boost mode output current rating meets the USB On-The-Go 500 mA output requirement. The maximum output current is up to 1.2 A. The boost operation can be enabled if the conditions are valid:

1. BAT above  $V_{OTG\_BAT}$
2. VBUS less than  $BAT + V_{SLEEP}$  (in sleep mode)
3. Boost mode operation is enabled (OTG\_CONFIG bit = 1)
4. Voltage at TS (thermistor) pin as a percentage of  $V_{REGN}$  is within acceptable range ( $V_{BHOT} < V_{TS} < V_{BCOLD}$ )
5. After 30-ms delay from boost mode enable

During boost mode, the status register VBUS\_STAT bits is set to 111, the VBUS output is 5.15 V and the output current can reach up to 1.2 A, selected through I<sup>2</sup>C (BOOST\_LIM bit). The boost output is maintained when BAT is above  $V_{OTG\_BAT}$  threshold.

When OTG is enabled, the device starts up with PFM and later transits to PWM to minimize the overshoot. The PFM\_DIS bit can be used to prevent PFM operation in either buck or boost configuration.

### 8.3.5 Host Mode and Standalone Power Management

#### 8.3.5.1 Host Mode and Default Mode in BQ25600 and BQ25600D

The BQ25600 and BQ25600D is a host controlled charger, but it can operate in default mode without host management. In default mode, the device can be used as an autonomous charger with no host or while host is in sleep mode. When the charger is in default mode, WATCHDOG\_FAULT bit is HIGH. When the charger is in host mode, WATCHDOG\_FAULT bit is LOW.

After power-on-reset, the device starts in default mode with watchdog timer expired, or default mode. All the registers are in the default settings. During default mode, any change on PSEL pin will make real time IINDPM register changes.

In default mode, the device keeps charging the battery with default 10-hour fast charging safety timer. At the end of the 10-hour, the charging is stopped and the buck converter continues to operate to supply system load.

Writing a 1 to the WD\_RST bit transitions the charger from default mode to host mode. All the device parameters can be programmed by the host. To keep the device in host mode, the host has to reset the watchdog timer by

writing 1 to WD\_RST bit before the watchdog timer expires (WATCHDOG\_FAULT bit is set), or disable watchdog timer by setting WATCHDOG bits = 00.

When the watchdog timer expires (WATCHDOG\_FAULT bit = 1), the device returns to default mode and all registers are reset to default values except IINDPM, VINDPM, BATFET\_RST\_EN, BATFET\_DLY, and BATFET\_DIS bits.



图 8-1. Watchdog Timer Flow Chart

### 8.3.6 Power Path Management

The device accommodates a wide range of input sources from USB, wall adapter, to car charger. The device provides automatic power path selection to supply the system (SYS) from input source (VBUS), battery (BAT), or both.

### 8.3.7 Battery Charging Management

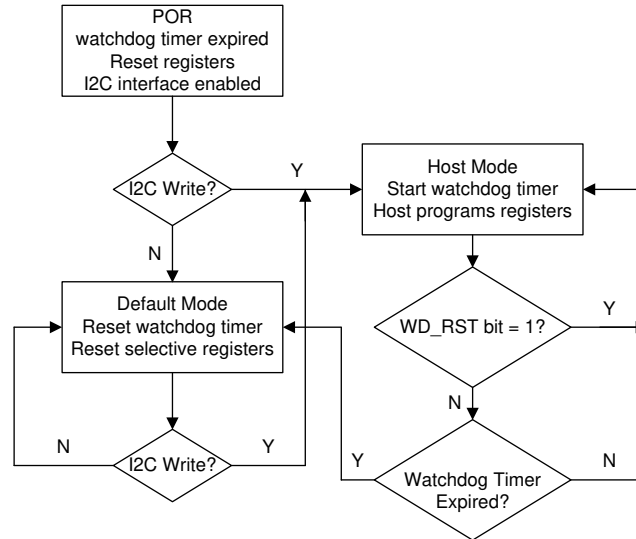
The device charges 1-cell Li-Ion battery with up to 3.0-A charge current for high capacity tablet battery. The 19.5-mΩ BATFET improves charging efficiency and minimize the voltage drop during discharging.

#### 8.3.7.1 Autonomous Charging Cycle

With battery charging enabled (CHG\_CONFIG bit = 1 and  $\overline{CE}$  pin is LOW), the device autonomously completes a charging cycle without host involvement. The device default charging parameters are listed in 表 8-4. The host can always control the charging operations and optimize the charging parameters by writing to the corresponding registers through I<sup>2</sup>C.

表 8-4. Charging Parameter Default Setting

DEFAULT MODE	BQ25600 and BQ25600D
Charging voltage	4.208V
Charging current	2.048 A
Precharge current	180 mA
Termination current	180 mA
Temperature profile	JEITA
Safety timer	10 hours

A new charge cycle starts when the following conditions are valid:

- Converter starts
- Battery charging is enabled (CHG\_CONFIG bit = 1 and I<sub>CHG</sub> register is not 0 mA and  $\overline{CE}$  is low)

- No thermistor fault on TS
- No safety timer fault
- BATFET is not forced to turn off (BATFET\_DIS bit = 0)

The charger device automatically terminates the charging cycle when the charging current is below termination threshold, battery voltage is above recharge threshold, and device not is in DPM mode or thermal regulation. When a fully charged battery is discharged below recharge threshold (selectable through VRECHG bit), the device automatically starts a new charging cycle. After the charge is done, toggle  $\overline{CE}$  pin or CHG\_CONFIG bit can initiate a new charging cycle.

The STAT output indicates the charging status: charging (LOW), charging complete or charge disable (HIGH) or charging fault (blinking). The STAT output can be disabled by setting EN\_ICHG\_MON bits = 11. In addition, the status register (CHRG\_STAT) indicates the different charging phases: 00-charging disable, 01-precharge, 10-fast charge (constant current) and constant voltage mode, 11-charging done. Once a charging cycle is completed, an INT is asserted to notify the host.

### 8.3.7.2 Battery Charging Profile

The device charges the battery in five phases: battery short, preconditioning, constant current, constant voltage and top-off trickle charging (optional). At the beginning of a charging cycle, the device checks the battery voltage and regulates current and voltage accordingly.

表 8-5. Charging Current Setting

V <sub>BAT</sub>	CHARGING CURRENT	REGISTER DEFAULT SETTING	CHRG_STAT
< 2.2 V	I <sub>SHORT</sub>	100 mA	01
2.2 V to 3 V	I <sub>PRECHG</sub>	180 mA	01
> 3 V	I <sub>CHG</sub>	2.048 A	10

If the charger device is in DPM regulation or thermal regulation during charging, the actual charging current will be less than the programmed value. In this case, termination is temporarily disabled and the charging safety timer is counted at half the clock rate.



图 8-2. Battery Charging Profile



### 8.3.7.3 Charging Termination

The device terminates a charge cycle when the battery voltage is above recharge threshold, and the current is below termination current. After the charging cycle is completed, the BATFET turns off. The converter keeps running to power the system, and BATFET can turn on again to engage Supplement Mode.

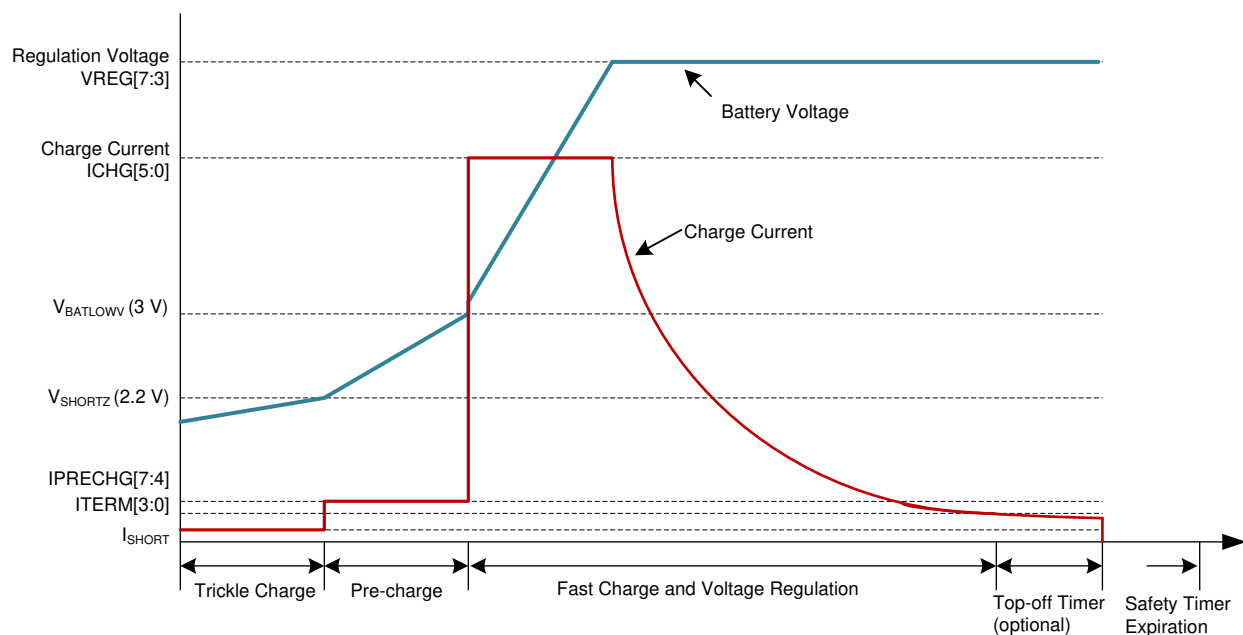
When termination occurs, the status register CHRG\_STAT is set to 11, and an INT pulse is asserted to the host. Termination is temporarily disabled when the charger device is in input current, voltage, or thermal regulation. Termination can be disabled by writing 0 to EN\_TERM bit prior to charge termination.

At low termination currents, due to the comparator offset, the actual termination current may be 10 mA-20 mA higher than the termination target. In order to compensate for comparator offset, a programmable top-off timer can be applied after termination is detected. The termination timer will follow safety timer constraints, such that if safety timer is suspended, so will the termination timer. Similarly, if safety timer is doubled, so will the termination timer. TOPOFF\_ACTIVE bit reports whether the top off timer is active or not. The host can read CHRG\_STAT and TOPOFF\_ACTIVE to find out the termination status.

Top off timer gets reset at one of the following conditions:

1. Charge disable to enable
2. Termination status low to high
3. REG\_RST register bit is set

The top-off timer settings are read in once termination is detected by the charger. Programming a top-off timer value after termination will have no effect unless a recharge cycle is initiated. An INT is asserted to the host when entering top-off timer segment as well as when top-off timer expires.

### 8.3.7.4 Thermistor Qualification

The charger device provides a single thermistor input for battery temperature monitor.

### 8.3.7.5 JEITA Guideline Compliance During Charging Mode

To improve the safety of charging Li-ion batteries, JEITA guideline was released on April 20, 2007. The guideline emphasized the importance of avoiding a high charge current and high charge voltage at certain low and high temperature ranges.

To initiate a charge cycle, the voltage on TS pin must be within the VT1 to VT5 thresholds. If TS voltage exceeds the T1-T5 range, the controller suspends charging and waits until the battery temperature is within the T1 to T5 range.

At cool temperature (T1-T2), JEITA recommends the charge current to be reduced to half of the charge current or lower. At warm temperature (T3-T5), JEITA recommends charge voltage less than 4.1 V.

The charger provides flexible voltage/current settings beyond the JEITA requirement. The voltage setting at warm temperature (T3-T5) can be VREG or 4.1V (configured by JEITA\_VSET). The current setting at cool temperature (T1-T2) can be further reduced to 20% of fast charge current (JEITA\_ISET).



图 8-3. JEITA Profile: Charging Current



图 8-4. JEITA Profile: Charging Voltage

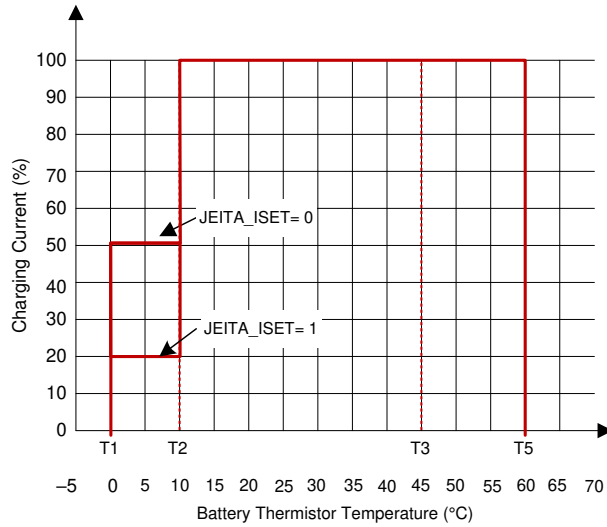

图 8-5. TS Resistor Network

方程式 1 through 方程式 2 describe updates to the resistor bias network.

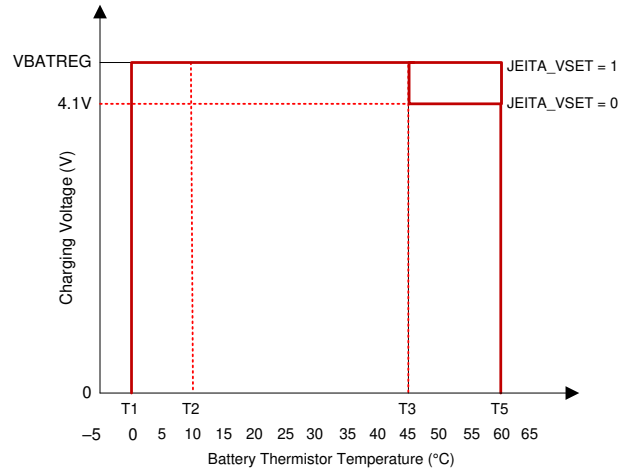
$$RT2 = \frac{V_{REGN} \times RTH_{COLD} \times RTH_{HOT} \times \left( \frac{1}{VT1} - \frac{1}{VT5} \right)}{RTH_{HOT} \times \left( \frac{V_{REGN}}{VT5} - 1 \right) - RTH_{COLD} \times \left( \frac{V_{REGN}}{VT1} - 1 \right)} \quad (1)$$

$$RT1 = \frac{\left( \left( \frac{V_{REGN}}{VT1} \right) - 1 \right)}{\left( \frac{1}{RT2} \right) + \left( \frac{1}{RTH_{COLD}} \right)} \quad (2)$$

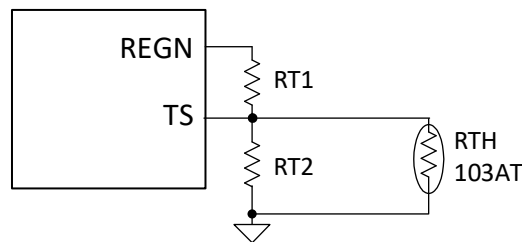
Select 0°C to 60°C range for Li-ion or Li-polymer battery:

- $RTH_{COLD} = 27.28 \text{ K}\Omega$
- $RTH_{HOT} = 3.02 \text{ K}\Omega$
- $RT1 = 5.23 \text{ K}\Omega$
- $RT2 = 30.9 \text{ K}\Omega$

### 8.3.7.6 Boost Mode Thermistor Monitor During Battery Discharge Mode

For battery protection during boost mode, the device monitors the battery temperature to be within the  $V_{BCOLD}$  to  $V_{BHOT}$  thresholds. When temperature is outside of the temperature thresholds, the boost mode is suspended. In addition,  $VBUS\_STAT$  bits are set to 000 and  $NTC\_FAULT$  is reported. Once temperature returns within thresholds, the boost mode is recovered and  $NTC\_FAULT$  is cleared.

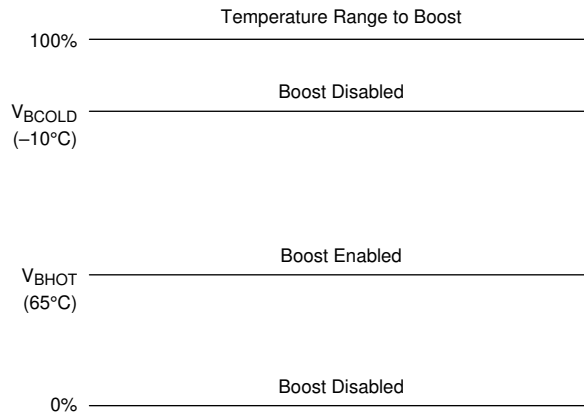

**图 8-6. TS Pin Thermistor Sense Threshold in Boost Mode**

### 8.3.7.7 Charging Safety Timer

The device has built-in safety timer to prevent extended charging cycle due to abnormal battery conditions. The safety timer is two hours when the battery is below  $V_{BATLOWV}$  threshold and 10 hours when the battery is higher than  $V_{BATLOWV}$  threshold.

The user can program fast charge safety timer through I<sup>2</sup>C (CHG\_TIMER bits). When safety timer expires, the fault register CHRG\_FAULT bits are set to 11 and an INT is asserted to the host. The safety timer feature can be disabled through I<sup>2</sup>C by setting EN\_TIMER bit.

During input voltage, current, JEITA cool or thermal regulation, the safety timer counts at half clock rate as the actual charge current is likely to be below the register setting. For example, if the charger is in input current regulation (IDPM\_STAT = 1) throughout the whole charging cycle, and the safety time is set to five hours, the safety timer will expire in 10 hours. This half clock rate feature can be disabled by writing 0 to TMR2X\_EN bit.

During the fault, timer is suspended. Once the fault goes away, the timer resumes counting. If user stops the current charging cycle, and start again, timer gets reset (toggle CE pin or CHRG\_CONFIG bit).

### 8.3.8 Protections

#### 8.3.8.1 Voltage and Current Monitoring in Converter Operation

The device closely monitors the input and system voltage, as well as internal FET currents for safe buck and boost mode operation.

##### 8.3.8.1.1 Voltage and Current Monitoring in Buck Mode

###### 8.3.8.1.1.1 Input Overvoltage (ACOV)

If VBUS voltage exceeds  $V_{VAC\_OV}$  (programmable via OVP[2:0] bits), the device stops switching immediately.

During input overvoltage event (ACOV), the fault register CHRG\_FAULT bits are set to 01. An INT pulse is asserted to the host. The device will automatically resume normal operation once the input voltage drops back below the OVP threshold.

###### 8.3.8.1.1.2 System Overvoltage Protection (SYSOVP)

The charger device clamps the system voltage during load transient so that the components connect to system would not be damaged due to high voltage. SYSOVP threshold is 350 mV above minimum system regulation voltage when the system is regulate at  $V_{SYS\_MIN}$ . Upon SYSOVP, converter stops switching immediately to clamp the overshoot. The charger provides 30-mA discharge current ( $I_{SYSLOAD}$ ) to bring down the system voltage.

### 8.3.8.2 Voltage and Current Monitoring in Boost Mode

The device closely monitors the VBUS voltage, as well as RBFET and LSFET current to ensure safe boost mode operation.

#### 8.3.8.2.1 VBUS Soft Start

When the boost function is enabled, the device soft-starts boost mode to avoid inrush current.

#### 8.3.8.2.2 VBUS Output Protection

The device monitors boost output voltage and other conditions to provide output short circuit and overvoltage protection. The boost build in accurate constant current regulation to allow OTG to adapt to various types of load. If a short circuit is detected on VBUS, boost turns off and retries 7 times. If retries are not successful, OTG is disabled with OTG\_CONFIG bit cleared. In addition, the BOOST\_FAULT bit is set and  $\overline{\text{INT}}$  pulse is generated. The BOOST\_FAULT bit can be cleared by host by reenabling boost mode

#### 8.3.8.2.3 Boost Mode Overvoltage Protection

When the VBUS voltage rises above regulation target and exceeds VOTG\_OVP, the device enters overvoltage protection which stops switching, clears OTG\_CONFIG bit and exits boost mode. At Boost overvoltage duration, the fault register bit (BOOST\_FAULT) is set high to indicate fault in boost operation. An INT is also asserted to the host.

### 8.3.8.3 Thermal Regulation and Thermal Shutdown

#### 8.3.8.3.1 Thermal Protection in Buck Mode

The BQ25600 and BQ25600D monitors the internal junction temperature  $T_j$  to avoid overheat of the chip and limits the IC surface temperature in buck mode. When the internal junction temperature exceeds thermal regulation limit (110°C), the device lowers down the charge current. During thermal regulation, the actual charging current is usually below the programmed battery charging current. Therefore, termination is disabled, the safety timer runs at half the clock rate, and the status register THERM\_STAT bit goes high.

Additionally, the device has thermal shutdown to turn off the converter and BATFET when IC surface temperature exceeds  $T_{\text{SHUT}}$ (160°C). The fault register CHRG\_FAULT is set to 1 and an  $\overline{\text{INT}}$  is asserted to the host. The BATFET and converter is enabled to recover when IC temperature is  $T_{\text{SHUT\_HYS}}$  (30°C) below  $T_{\text{SHUT}}$ (160°C).

#### 8.3.8.3.2 Thermal Protection in Boost Mode

The device monitors the internal junction temperature to provide thermal shutdown during boost mode. When IC junction temperature exceeds  $T_{\text{SHUT}}$  (160°C), the boost mode is disabled by setting OTG\_CONFIG bit low and BATFET is turned off. When IC junction temperature is below  $T_{\text{SHUT}}$ (160°C) -  $T_{\text{SHUT\_HYS}}$  (30°C), the BATFET is enabled automatically to allow system to restore and the host can re-enable OTG\_CONFIG bit to recover.

### 8.3.8.4 Battery Protection

#### 8.3.8.4.1 Battery Overvoltage Protection (BATOVP)

The battery overvoltage limit is clamped at 4% above the battery regulation voltage. When battery over voltage occurs, the charger device immediately disables charging. The fault register BAT\_FAULT bit goes high and an INT is asserted to the host.

#### 8.3.8.4.2 Battery Overdischarge Protection

When battery is discharged below  $V_{\text{BAT\_DPL\_FALL}}$ , the BATFET is turned off to protect battery from overdischarge. To recover from overdischarge latch-off, an input source plug-in is required at VBUS. The battery is charged with  $I_{\text{SHORT}}$  (typically 100 mA) current when the  $V_{\text{BAT}} < V_{\text{SHORT}}$ , or precharge current as set in IPRECHG register when the battery voltage is between  $V_{\text{SHORTZ}}$  and  $V_{\text{BAT\_LOWV}}$ .

#### 8.3.8.4.3 System Overcurrent Protection

When the system is shorted or significantly overloaded ( $I_{\text{BAT}} > I_{\text{BATOP}}$ ) and the current exceeds BATFET overcurrent limit, the BATFET latches off. Section BATFET Enable (Exit Shipping Mode) can reset the latch-off condition and turn on BATFET.

## 8.4 Device Functional Modes

### 8.4.1 Narrow VDC Architecture

The device deploys Narrow VDC architecture (NVDC) with BATFET separating system from battery. The minimum system voltage is set by SYS\_MIN bits. Even with a fully depleted battery, the system is regulated above the minimum system voltage.

When the battery is below minimum system voltage setting, the BATFET operates in linear mode (LDO mode), and the system is typically 180 mV above the minimum system voltage setting. As the battery voltage rises above the minimum system voltage, BATFET is fully on and the voltage difference between the system and battery is the  $V_{DS}$  of BATFET.

When the battery charging is disabled and above minimum system voltage setting or charging is terminated, the system is always regulated at typically 50 mV above battery voltage. The status register VSYS\_STAT bit goes high when the system is in minimum system voltage regulation.

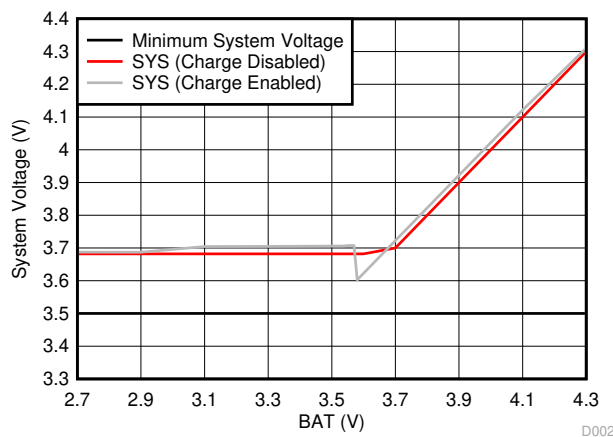

**图 8-7. System Voltage vs Battery Voltage**

### 8.4.2 Dynamic Power Management

To meet maximum current limit in USB spec and avoid over loading the adapter, the device features Dynamic Power management (DPM), which continuously monitors the input current and input voltage. When input source is over-loaded, either the current exceeds the input current limit (IINDPM) or the voltage falls below the input voltage limit (VINDPM). The device then reduces the charge current until the input current falls below the input current limit and the input voltage rises above the input voltage limit.

When the charge current is reduced to zero, but the input source is still overloaded, the system voltage starts to drop. Once the system voltage falls below the battery voltage, the device automatically enters the supplement mode where the BATFET turns on and battery starts discharging so that the system is supported from both the input source and battery.

During DPM mode, the status register bits VDPM\_STAT (VINDPM) or IDPM\_STAT (IINDPM) goes high. shows the DPM response with 9-V/1.2-A adapter, 3.2-V battery, charge current and 3.5-V minimum system voltage setting.



图 8-8. DPM Response

### 8.4.3 Supplement Mode

When the system voltage falls 180 mV ( $V_{BAT} > V_{SYS\_MIN}$ ) or 45 mV ( $V_{BAT} < V_{SYS\_MIN}$ ) below the battery voltage, the BATFET turns on and the BATFET gate is regulated the gate drive of BATFET so that the minimum BATFET  $V_{DS}$  stays at 30 mV when the current is low. This prevents oscillation from entering and exiting the supplement mode.

As the discharge current increases, the BATFET gate is regulated with a higher voltage to reduce  $R_{DS(ON)}$  until the BATFET is in full conduction. At this point onwards, the BATFET  $V_{DS}$  linearly increases with discharge current. 图 8-9 shows the V-I curve of the BATFET gate regulation operation. BATFET turns off to exit supplement mode when the battery is below battery depletion threshold.

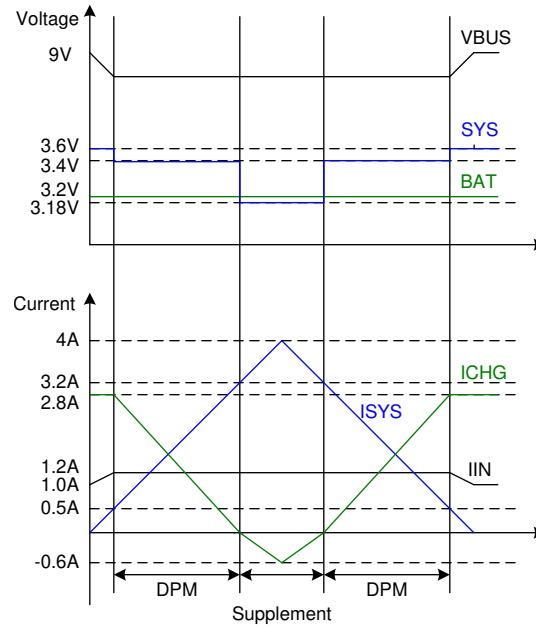

图 8-9. BATFET V-I Curve

### 8.4.4 Shipping Mode and $\overline{QON}$ Pin

#### 8.4.4.1 BATFET Disable Mode (Shipping Mode)

To extend battery life and minimize power when system is powered off during system idle, shipping, or storage, the device can turn off BATFET so that the system voltage is zero to minimize the battery leakage current. When

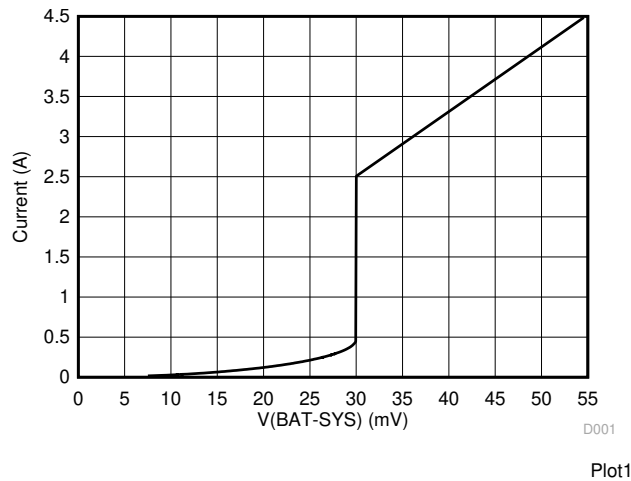
the host set BATFET\_DIS bit, the charger can turn off BATFET immediately or delay by  $t_{SM\_DLY}$  as configured by BATFET\_DLY bit.

#### 8.4.4.2 BATFET Enable (Exit Shipping Mode)

When the BATFET is disabled (in shipping mode) and indicated by setting BATFET\_DIS, one of the following events can enable BATFET to restore system power:

1. Plug in adapter
2. Clear BATFET\_DIS bit
3. Set REG\_RST bit to reset all registers including BATFET\_DIS bit to default (0)
4. A logic high to low transition on  $\overline{QON}$  pin with  $t_{SHIPMODE}$  deglitch time to enable BATFET to exit shipping mode

#### 8.4.4.3 BATFET Full System Reset

The BATFET functions as a load switch between battery and system when input source is not plugged in. By changing the state of BATFET from on to off, systems connected to SYS can be effectively forced to have a power-on-reset. The  $\overline{QON}$  pin supports push-button interface to reset system power without host by changing the state of BATFET.

When the  $\overline{QON}$  pin is driven to logic low for  $t_{QON\_RST}$  while input source is not plugged in and BATFET is enabled (BATFET\_DIS = 0), the BATFET is turned off for  $t_{BATFET\_RST}$  and then it is re-enabled to reset system power. This function can be disabled by setting BATFET\_RST\_EN bit to 0.

#### 8.4.4.4 $\overline{QON}$ Pin Operations

The  $\overline{QON}$  pin incorporates two functions to control BATFET.  $\overline{QON}$  is pulled up to  $V_{QON}$  by an internal 200-k $\Omega$  pull-up resistor.

1. BATFET Enable: A  $\overline{QON}$  logic transition from high to low with longer than  $t_{SHIPMODE}$  deglitch turns on BATFET to exit shipping mode. When exiting shipping mode, HIZ is enabled (EN\_HIZ = 1) as well. HIZ can be disabled (EN\_HIZ = 0) by the host after exiting shipping mode. OTG cannot be enabled (OTG\_CONFIG = 1) until HIZ is disabled.
2. BATFET Reset: When  $\overline{QON}$  is driven to logic low by at least  $t_{QON\_RST}$  while adapter is not plugged in (and BATFET\_DIS = 0), the BATFET is turned off for  $t_{BATFET\_RST}$ . The BATFET is re-enabled after  $t_{BATFET\_RST}$  duration. This function allows systems connected to SYS to have power-on-reset. This function can be disabled by setting BATFET\_RST\_EN bit to 0.

图 8-10 shows the sample external configurations for each.



图 8-10.  $\overline{QON}$  Timing

图 8-11.  $\overline{\text{QON}}$  Circuit

### 8.4.5 Status Outputs ( $\overline{\text{PG}}$ , STAT, INT)

#### 8.4.5.1 Power Good Indicator ( $\overline{\text{PG}}$ Pin and PG\_STAT Bit)

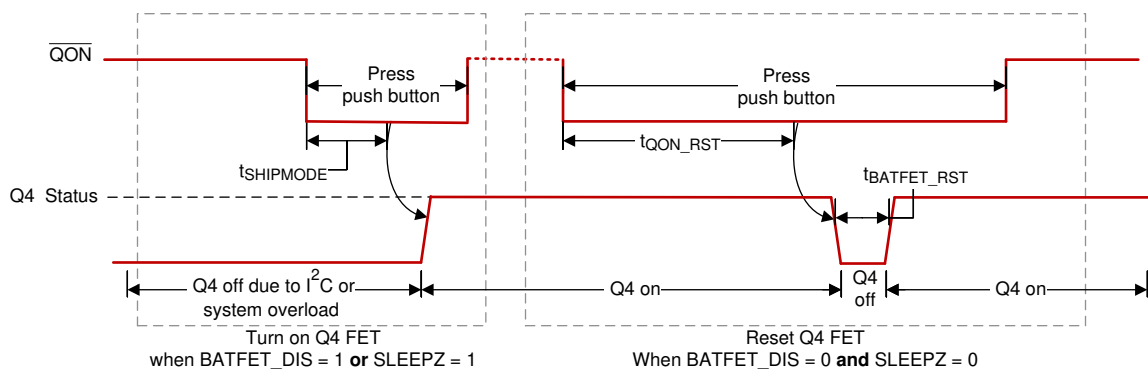
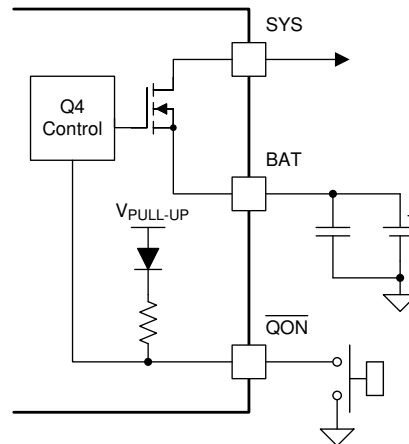
The PG\_STAT bit goes HIGH and  $\overline{\text{PG}}$  pin goes LOW to indicate a good input source when:

- VBUS above  $V_{\text{VBUS\_UVLO}}$
- VBUS above battery (not in sleep)
- VBUS below  $V_{\text{VAC\_OV}}$  threshold
- VBUS above  $V_{\text{VBUSMin}}$  (typical 3.8 V) when  $I_{\text{BADSRC}}$  (typical 30 mA) current is applied (not a poor source)
- Completed input Source Type Detection

#### 8.4.5.2 Charging Status Indicator (STAT)

The device indicates charging state on the open drain STAT pin. The STAT pin can drive LED. The STAT pin function can be disabled by setting the EN\_ICHG\_MON bits = 11.

表 8-6. STAT Pin State

CHARGING STATE	STAT INDICATOR
Charging in progress (including recharge)	LOW
Charging complete	HIGH
Sleep mode, charge disable	HIGH
Charge suspend (input overvoltage, TS fault, timer fault or system overvoltage) Boost Mode suspend (due to TS fault)	Blinking at 1 Hz

#### 8.4.5.3 Interrupt to Host ( $\overline{\text{INT}}$ )

In some applications, the host does not always monitor the charger operation. The INT pulse notifies the system on the device operation. The following events will generate 256-  $\mu$ s INT pulse.

- USB/adaptor source identified (through PSEL pin or DPDM detection)
- Good input source detected
  - VBUS above battery (not in sleep)
  - VBUS below  $V_{\text{VAC\_OV}}$  threshold
  - VBUS above  $V_{\text{VBUSMin}}$  (typical 3.8 V) when  $I_{\text{BADSRC}}$  (typical 30 mA) current is applied (not a poor source)
- Input removed
- Charge complete
- Any FAULT event in REG09
- VINDPM / IINDPM event detected (maskable)



When a fault occurs, the charger device sends out INT and keeps the fault state in REG09 until the host reads the fault register. Before the host reads REG09 and all the faults are cleared, the charger device would not send any INT upon new faults. To read the current fault status, the host has to read REG09 two times consecutively. The first read reports the pre-existing fault register status and the second read reports the current fault register status.

## 8.5 Programming

### 8.5.1 Serial Interface

The device uses I<sup>2</sup>C compatible interface for flexible charging parameter programming and instantaneous device status reporting. I<sup>2</sup>C is a bi-directional 2-wire serial interface developed by Philips Semiconductor (now NXP Semiconductors). Only two bus lines are required: a serial data line (SDA) and a serial clock line (SCL). Devices can be considered as masters or slaves when performing data transfers. A master is the device which initiates a data transfer on the bus and generates the clock signals to permit that transfer. At that time, any device addressed is considered a slave.

The device operates as a slave device with address 6BH, receiving control inputs from the master device like micro controller or a digital signal processor through REG00-REG0B. Register read beyond REG0B (0x0B) returns 0xFF. The I<sup>2</sup>C interface supports both standard mode (up to 100 kbits), and fast mode (up to 400 kbits). connecting to the positive supply voltage via a current source or pull-up resistor. When the bus is free, both lines are HIGH. The SDA and SCL pins are open drain.

#### 8.5.1.1 Data Validity

The data on the SDA line must be stable during the HIGH period of the clock. The HIGH or LOW state of the data line can only change when the clock signal on the SCL line is LOW. One clock pulse is generated for each data bit transferred.



图 8-12. Bit Transfer on the I<sup>2</sup>C Bus

#### 8.5.1.2 START and STOP Conditions

All transactions begin with a START (S) and can be terminated by a STOP (P). A HIGH to LOW transition on the SDA line while SCL is HIGH defines a START condition. A LOW to HIGH transition on the SDA line when the SCL is HIGH defines a STOP condition. START and STOP conditions are always generated by the master. The bus is considered busy after the START condition, and free after the STOP condition.

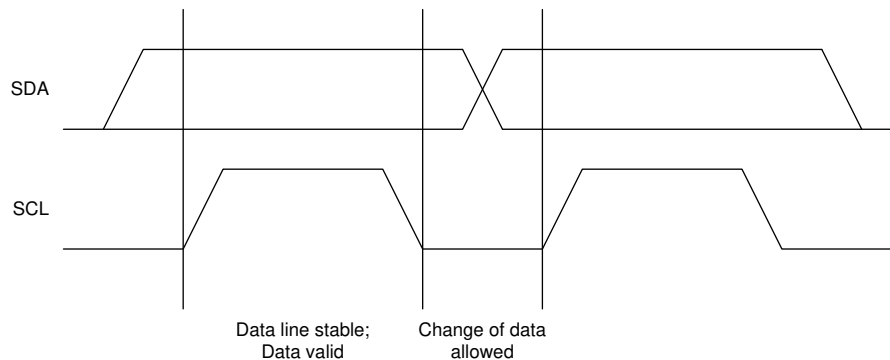

图 8-13. TS START and STOP conditions

### 8.5.1.3 Byte Format

Every byte on the SDA line must be 8 bits long. The number of bytes to be transmitted per transfer is unrestricted. Each byte has to be followed by an Acknowledge bit. Data is transferred with the Most Significant Bit (MSB) first. If a slave cannot receive or transmit another complete byte of data until it has performed some other function, it can hold the clock line SCL low to force the master into a wait state (clock stretching). Data transfer then continues when the slave is ready for another byte of data and release the clock line SCL.

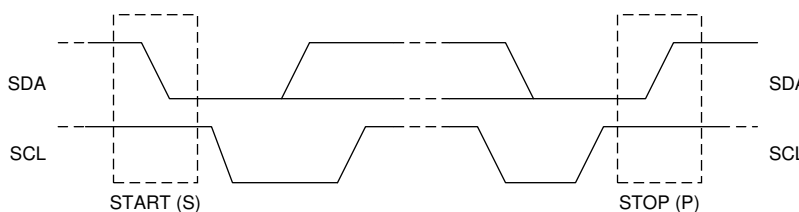

图 8-14. Data Transfer on the I<sup>2</sup>C Bus

### 8.5.1.4 Acknowledge (ACK) and Not Acknowledge (NACK)

The acknowledge takes place after every byte. The acknowledge bit allows the receiver to signal the transmitter that the byte was successfully received and another byte may be sent. All clock pulses, including the acknowledge ninth clock pulse, are generated by the master. The transmitter releases the SDA line during the acknowledge clock pulse so the receiver can pull the SDA line LOW and it remains stable LOW during the HIGH period of this clock pulse.

When SDA remains HIGH during the ninth clock pulse, this is the Not Acknowledge signal. The master can then generate either a STOP to abort the transfer or a repeated START to start a new transfer.

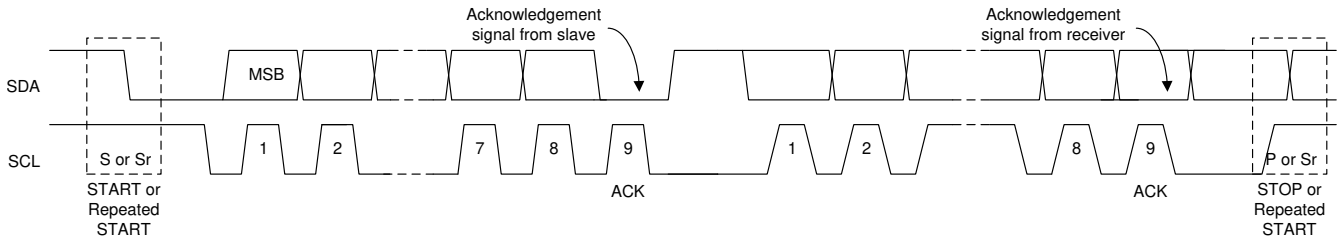
### 8.5.1.5 Slave Address and Data Direction Bit

After the START, a slave address is sent. This address is 7 bits long followed by the eighth bit as a data direction bit (bit R/W). A zero indicates a transmission (WRITE) and a one indicates a request for data (READ).



图 8-15. Complete Data Transfer

### 8.5.1.6 Single Read and Write

If the register address is not defined, the charger IC send back NACK and go back to the idle state.

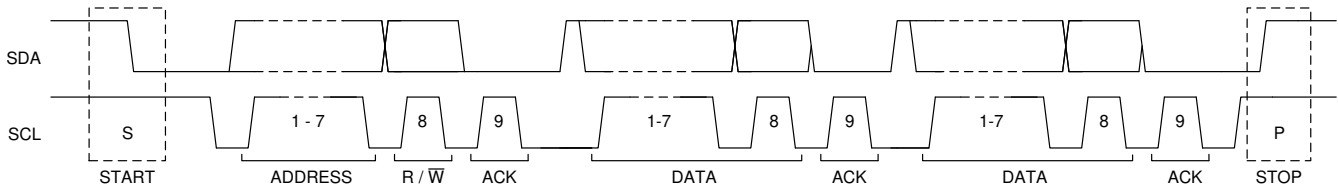

图 8-16. Single Write



图 8-17. Single Read

### 8.5.1.7 Multi-Read and Multi-Write

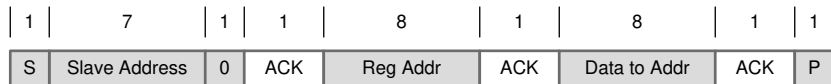
The charger device supports multi-read and multi-write on REG00 through REG0B.

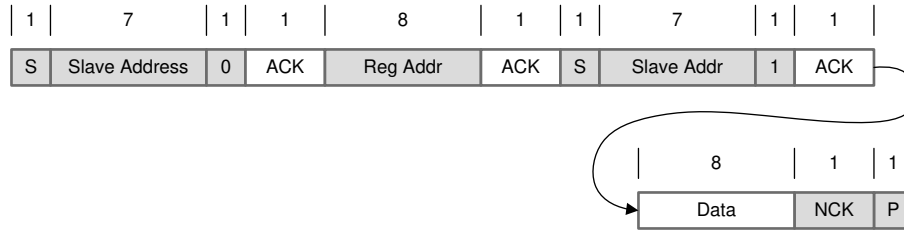

图 8-18. Multi-Write



图 8-19. Multi-Read

REG09 is a fault register. It keeps all the fault information from last read until the host issues a new read. For example, if Charge Safety Timer Expiration fault occurs but recovers later, the fault register REG09 reports the fault when it is read the first time, but returns to normal when it is read the second time. In order to get the fault information at present, the host has to read REG09 for the second time. The only exception is NTC\_FAULT which always reports the actual condition on the TS pin. In addition, REG09 does not support multi-read and multi-write.

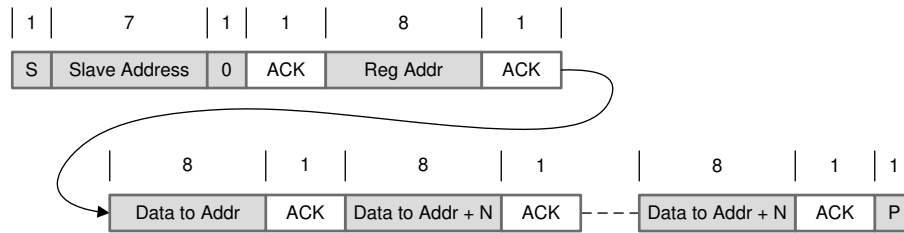
## 8.6 Register Maps

I<sup>2</sup>C Slave Address: 6BH

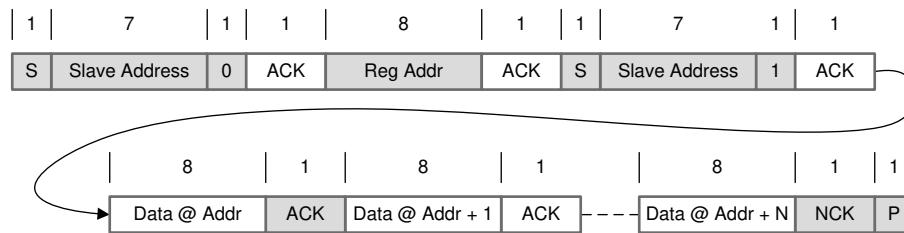
### 8.6.1 REG00

表 8-7. REG00 Field Descriptions

Bit	Field	POR	Type	Reset	Description	Comment
7	EN_HIZ	0	R/W	by REG_RST by Watchdog	0 - Disable, 1 - Enable	Enable HIZ Mode 0 - Disable (default) 1 - Enable
6	EN_ICHG_MON[1]	0	R/W	by REG_RST	00 - Enable STAT pin function (default)	
5	EN_ICHG_MON[0]	0	R/W	by REG_RST	01 - Reserved 10 - Reserved 11 - Disable STAT pin function (float pin)	
4	IINDPM[4]	1	R/W	by REG_RST	1600 mA	Input Current Limit Offset: 100 mA Range: 100 mA (000000) - 3.2 A (11111) Default: 2400 mA (10111), maximum input current limit, not typical. IINDPM bits are changed automatically after input source detection is completed BQ25600D USB SDP = 500 mA USB DCP = 2.4 A Unknown Adapter = 500 mA Non-Standard Adapter = 1 A, 2 A, 2.1 A, or 2.4 A BQ25600 PSEL = Hi = 500 mA PSEL = Lo = 2.4 A Host can over-write IINDPM register bits after input source detection is completed.
3	IINDPM[3]	0	R/W	by REG_RST	800 mA	
2	IINDPM[2]	1	R/W	by REG_RST	400 mA	
1	IINDPM[1]	1	R/W	by REG_RST	200 mA	
0	IINDPM[0]	1	R/W	by REG_RST	100 mA	

LEGEND: R/W = Read/Write; R = Read only

## 8.6.2 REG01

**表 8-8. REG01 Field Descriptions**

Bit	Field	POR	Type	Reset	Description	Comment
7	PFM_DIS	0	R/W	by REG_RST	0 - Enable PFM 1 - Disable PFM	Default: 0 - Enable
6	WD_RST	0	R/W	by REG_RST by Watchdog	I <sup>2</sup> C Watchdog Timer Reset 0 - Normal ; 1 - Reset	Default: Normal (0) Back to 0 after watchdog timer reset
5	OTG_CONFIG	0	R/W	by REG_RST by Watchdog	0 - OTG Disable 1 - OTG Enable	Default: OTG disable (0) Note: 1. OTG_CONFIG would over-ride Charge Enable Function in CHG_CONFIG
4	CHG_CONFIG	1	R/W	by REG_RST by Watchdog	0 - Charge Disable 1 - Charge Enable	Default: Charge Battery (1) Note: 1. Charge is enabled when both CE pin is pulled low AND CHG_CONFIG bit is 1.
3	SYS_MIN[2]	1	R/W	by REG_RST	System Minimum Voltage	000: 2.6 V 001: 2.8 V 010: 3 V 011: 3.2 V 100: 3.4 V 101: 3.5 V 110: 3.6 V 111: 3.7 V Default: 3.5 V (101)
2	SYS_MIN[1]	0	R/W	by REG_RST		
1	SYS_MIN[0]	1	R/W	by REG_RST		
0	MIN_VBAT_SEL	0	R/W	by REG_RST		
					0 - 2.8 V BAT falling, 1 - 2.5 V BAT falling	Minimum battery voltage for OTG mode. Default falling 2.8 V (0); Rising threshold 3.0 V (0)

LEGEND: R/W = Read/Write; R = Read only

## 8.6.3 REG02

表 8-9. REG02 Field Descriptions

Bit	Field	POR	Type	Reset	Description	Comment
7	BOOST_LIM	1	R/W	by REG_RST by Watchdog	0 - 0.5 A 1 - 1.2 A	Default: 1.2 A (1) Note: The current limit options listed are minimum current limit specs.
6	Q1_FULLON	0	R/W	by REG_RST	0 - Use higher Q1 RDSON when programmed IINDPM < 700mA (better accuracy) 1 - Use lower Q1 RDSON always (better efficiency)	In boost mode, full FET is always used and this bit has no effect
5	ICHG[5]	1	R/W	by REG_RST by Watchdog	1920 mA	Fast Charge Current Default: 2040 mA (100010) Range: 0 mA (0000000) - 3000 mA (110010) Note: I <sub>CHG</sub> = 0 mA disables charge. I <sub>CHG</sub> > 3000 mA (110010 clamped to register value 3000 mA (110010))
4	ICHG[4]	0	R/W	by REG_RST by Watchdog	960 mA	
3	ICHG[3]	0	R/W	by REG_RST by Watchdog	480 mA	
2	ICHG[2]	0	R/W	by REG_RST by Watchdog	240 mA	
1	ICHG[1]	1	R/W	by REG_RST by Watchdog	120 mA	
0	ICHG[0]	0	R/W	by REG_RST by Watchdog	60 mA	

LEGEND: R/W = Read/Write; R = Read only

### 8.6.4 REG03

表 8-10. REG03 Field Descriptions

Bit	Field	POR	Type	Reset	Description	Comment
7	IPRECHG[3]	0	R/W	by REG_RST by Watchdog	480 mA	Precharge Current Default: 180 mA (0010) Offset: 60 mA Note: IPRECHG > 780 mA clamped to 780 mA (1100)
6	IPRECHG[2]	0	R/W	by REG_RST by Watchdog	240 mA	
5	IPRECHG[1]	1	R/W	by REG_RST by Watchdog	120 mA	
4	IPRECHG[0]	0	R/W	by REG_RST by Watchdog	60 mA	
3	ITERM[3]	0	R/W	by REG_RST by Watchdog	480 mA	Termination Current Default: 180 mA (0010) Offset: 60 mA Note: ITERM > 780 mA clamped to 780 mA(1100)
2	ITERM[2]	0	R/W	by REG_RST by Watchdog	240 mA	
1	ITERM[1]	1	R/W	by REG_RST by Watchdog	120 mA	
0	ITERM[0]	0	R/W	by REG_RST by Watchdog	60 mA	

LEGEND: R/W = Read/Write; R = Read only

## 8.6.5 REG04

表 8-11. REG04 Field Descriptions

Bit	Field	POR	Type	Reset	Description	Comment
7	VREG[4]	0	R/W	by REG_RST by Watchdog	512 mV	Charge Voltage Offset: 3.856 V Range: 3.856 V to 4.624 V (11000) Default: 4.208 V (01011) Special Value: (01111): 4.352 V Note: Value above 11000 (4.624 V) is clamped to register value 11000 (4.624 V)
6	VREG[3]	1	R/W	by REG_RST by Watchdog	256 mV	
5	VREG[2]	0	R/W	by REG_RST by Watchdog	128 mV	
4	VREG[1]	1	R/W	by REG_RST by Watchdog	64 mV	
3	VREG[0]	1	R/W	by REG_RST by Watchdog	32 mV	
2	TOPOFF_TIMER[1]	0	R/W	by REG_RST by Watchdog	00 - Disabled (Default) 01 - 15 minutes	The extended time following the termination condition is met. When disabled, charge terminated when termination conditions are met
1	TOPOFF_TIMER[0]	0	R/W	by REG_RST by Watchdog	10 - 30 minutes 11 - 45 minutes	
0	VRECHG	0	R/W	by REG_RST by Watchdog	0 - 100 mV 1 - 200 mV	Recharge threshold Default: 100 mV (0)

LEGEND: R/W = Read/Write; R = Read only



## 8.6.6 REG05

表 8-12. REG05 Field Descriptions

Bit	Field	POR	Type	Reset	Description	Comment
7	EN_TERM	1	R/W	by REG_RST by Watchdog	0 - Disable 1 - Enable	Default: Enable termination (1)
6	OVPFET_DIS	0	R/W	by REG_RST by Watchdog	0 - Enable OVPFET 1 - Disable OVPFET	Default: Enable OVPFET (0) Note: This bit only takes effect when EN_HIZ bit is active
5	WATCHDOG[1]	0	R/W	by REG_RST by Watchdog	00 - Disable timer, 01 - 40 s, 10 - 80 s, 11 - 160 s	Default: 40 s (01)
4	WATCHDOG[0]	1	R/W	by REG_RST by Watchdog		
3	EN_TIMER	1	R/W	by REG_RST by Watchdog	0 - Disable 1 - Enable both fast charge and precharge timer	Default: Enable (1)
2	CHG_TIMER	1	R/W	by REG_RST by Watchdog	0 - 5 hrs 1 - 10 hrs	Default: 10 hours (1)
1	TREG	1	R/W	by REG_RST by Watchdog	Thermal Regulation Threshold: 0 - 90°C 1 - 110°C	Default: 110°C (1)
0	JEITA_ISET (0C-10C)	1	R/W	by REG_RST by Watchdog	0 - 50% of ICHG 1 - 20% of ICHG	Default: 20% (1)

LEGEND: R/W = Read/Write; R = Read only

## 8.6.7 REG06

表 8-13. REG06 Field Descriptions

Bit	Field	POR	Type	Reset	Description	Comment
7	OVP[1]	0	R/W	by REG_RST	Default: 6.5 V (01)	VAC OVP threshold: 00 - 5.5 V 01 - 6.5 V (5-V input) 10 - 10.5 V (9-V input) 11 - 14 V (12-V input)
6	OVP[0]	1	R/W	by REG_RST		
5	BOOSTV[1]	1	R/W	by REG_RST		Boost Regulation Voltage: 00 - 4.85 V 01 - 5.00 V 10 - 5.15 V 11 - 5.30 V
4	BOOSTV[0]	0	R/W	by REG_RST		
3	VINDPM[3]	0	R/W	by REG_RST	800 mV	Absolute VINDPM Threshold Offset: 3.9 V Range: 3.9 V (0000) - 5.4 V (1111) Default: 4.5 V (0110)
2	VINDPM[2]	1	R/W	by REG_RST	400 mV	
1	VINDPM[1]	1	R/W	by REG_RST	200 mV	
0	VINDPM[0]	0	R/W	by REG_RST	100 mV	

LEGEND: R/W = Read/Write; R = Read only

**8.6.8 REG07**
**表 8-14. REG07 Field Descriptions**

Bit	Field	POR	Type	Reset	Description	Comment
7	IINDET_EN	0	R/W	by REG_RST by Watchdog	0 - Not in D+/D - detection (or PSEL detection); 1 - Force D+/D - detection	Default: Not in DPDM detection (0) Note: For PSEL part, reads PSEL pin value
6	TMR2X_EN	1	R/W	by REG_RST by Watchdog	0 - Disable 1 - Safety timer slowed by 2X during input DPM (both V and I) or JEITA cool, or thermal regulation	
5	BATFET_DIS	0	R/W	by REG_RST	0 - Allow Q4 turn on, 1 - Turn off Q4 with $t_{\text{BATFET\_DLY}}$ delay time (REG07[3])	Default: Allow Q4 turn on(0)
4	JEITA_VSET (45C-60C)	0	R/W	by REG_RST by Watchdog	0 - Set Charge Voltage to 4.1V (max), 1 - Set Charge Voltage to VREG	
3	BATFET_DLY	1	R/W	by REG_RST	0 - Turn off BATFET immediately when BATFET_DIS bit is set 1 - Turn off BATFET after $t_{\text{BATFET\_DLY}}$ (typ. 10 s) when BATFET_DIS bit is set	Default: 1 Turn off BATFET after $t_{\text{BATFET\_DLY}}$ (typ. 10 s) when BATFET_DIS bit is set
2	BATFET_RST_EN	1	R/W	by REG_RST by Watchdog	0 - Disable BATFET reset function 1 - Enable BATFET reset function	Default: 1 Enable BATFET reset function
1	VDPM_BAT_TRACK[1]	0	R/W	by REG_RST	00 - Disable function (VINDPM set by register)	Sets VINDPM to track BAT voltage. Actual VINDPM is higher of register value and VBAT + VDPM_BAT_TRACK
0	VDPM_BAT_TRACK[0]	0	R/W	by REG_RST	01 - VBAT + 200 mV 10 - VBAT + 250 mV 11 - VBAT + 300 mV	

LEGEND: R/W = Read/Write; R = Read only

## 8.6.9 REG08

表 8-15. REG08 Field Descriptions

Bit	Field	POR	Type	Reset	Description
7	VBUS_STAT[2]	x	R	NA	VBUS Status register BQ25600D 000: No input 001: USB Host SDP 010: USB CDP: (1.5A) 011: USB DCP (2.4 A) 101: Unknown Adapter (500 mA) 110: Non-Standard Adapter (1A/2A/2.1A/2.4A) 111: OTG
6	VBUS_STAT[1]	x	R	NA	
5	VBUS_STAT[0]	x	R	NA	BQ25600 000 - No input 001 - USB Host SDP (500 mA) → PSEL HIGH 011 - Adapter 2.4 A → PSEL LOW 111 - OTG Software current limit is reported in IINDPM register
4	CHRG_STAT[1]	x	R	NA	Charging status: 00 - Not Charging 01 - Pre-charge ( $< V_{BATLOWV}$ ) 10 - Fast Charging 11 - Charge Termination
3	CHRG_STAT[0]	x	R	NA	
2	PG_STAT	x	R	NA	Power Good status: 0 - Power Not Good 1 - Power Good
1	THERM_STAT	x	R	NA	0 - Not in thermal regulation 1 - In thermal regulation
0	VSYS_STAT	x	R	NA	0 - Not in $V_{SYS\_MIN}$ regulation ( $BAT > V_{SYS\_MIN}$ ) 1 - In $V_{SYS\_MIN}$ regulation ( $BAT < V_{SYS\_MIN}$ )

LEGEND: R/W = Read/Write

## 8.6.10 REG09

**表 8-16. REG09 Field Descriptions**

Bit	Field	POR	Type	Reset	Description
7	WATCHDOG_FAULT	x	R	NA	0 - Normal, 1- Watchdog timer expiration
6	BOOST_FAULT	x	R	NA	0 - Normal, 1 - VBUS overloaded in OTG, or VBUS OVP, or battery is too low (any conditions that cannot start boost function)
5	CHRG_FAULT[1]	x	R	NA	00 - Normal, 01 - input fault (VAC OVP or VBAT < VBUS < 3.8 V), 10 - Thermal shutdown, 11 - Charge Safety Timer Expiration
4	CHRG_FAULT[0]	x	R	NA	
3	BAT_FAULT	x	R	NA	0 - Normal, 1 - BATOVP
2	NTC_FAULT[2]	x	R	NA	JEITA 000 - Normal, 010 - Warm, 011 - Cool, 101 - Cold, 110 - Hot (Buck mode) 000 - Normal, 101 - Cold, 110 - Hot (Boost mode)
1	NTC_FAULT[1]	x	R	NA	
0	NTC_FAULT[0]	x	R	NA	

LEGEND: R/W = Read/Write; R = Read only

## 8.6.11 REG0A

表 8-17. REG0A Field Descriptions

Bit	Field	POR	Type	Reset	Description
7	VBUS_GD	x	R	NA	0 - Not VBUS attached, 1 - VBUS Attached
6	VINDPM_STAT	x	R	NA	0 - Not in VINDPM, 1 - in VINDPM
5	IINDPM_STAT	x	R	NA	0 - Not in IINDPM, 1 - in IINDPM
4	Reserved	x	R	NA	
3	TOPOFF_ACTIVE	x	R	NA	0 - Top off timer not counting. 1 - Top off timer counting
2	ACOV_STAT	x	R	NA	0 - Device is NOT in ACOV 1 - Device is in ACOV
1	VINDPM_INT_MASK	0	R/W	by REG_RST	0 - Allow VINDPM INT pulse 1 - Mask VINDPM INT pulse
0	IINDPM_INT_MASK	0	R/W	by REG_RST	0 - Allow IINDPM INT pulse 1 - Mask IINDPM INT pulse

LEGEND: R/W = Read/Write; R = Read only

## 8.6.12 REG0B

**表 8-18. REG0B Field Descriptions**

Bit	Field	POR	Type	Reset	Description
7	REG_RST	0	R/W	NA	Register reset 0 - Keep current register setting 1 - Reset to default register value and reset safety timer Note: Bit resets to 0 after register reset is completed
6	PN[3]	x	R	NA	BQ25600: 0000 BQ25600D: 0001
5	PN[2]	x	R	NA	
4	PN[1]	x	R	NA	
3	PN[0]	x	R	NA	
2	Reserved	x	R	NA	
1	DEV_REV[1]	x	R	NA	
0	DEV_REV[0]	x	R	NA	

LEGEND: R/W = Read/Write; R = Read only

## 9 Application and Implementation

### 备注

以下应用部分中的信息不属于 TI 器件规格的范围，TI 不担保其准确性和完整性。TI 的客户应负责确定器件是否适用于其应用。客户应验证并测试其设计，以确保系统功能。

### 9.1 Application Information

A typical application consists of the device configured as an I<sup>2</sup>C controlled power path management device and a single cell battery charger for Li-Ion and Li-polymer batteries used in a wide range of Smartphone and other portable devices. It integrates an input reverse-block FET (RBFET, Q1), high-side switching FET (HSFET, Q2), low-side switching FET (LSFET, Q3), and battery FET (BATFET Q4) between the system and battery. The device also integrates a bootstrap diode for the high-side gate drive.

## 9.2 Typical Application



图 9-1. Power Path Management Application



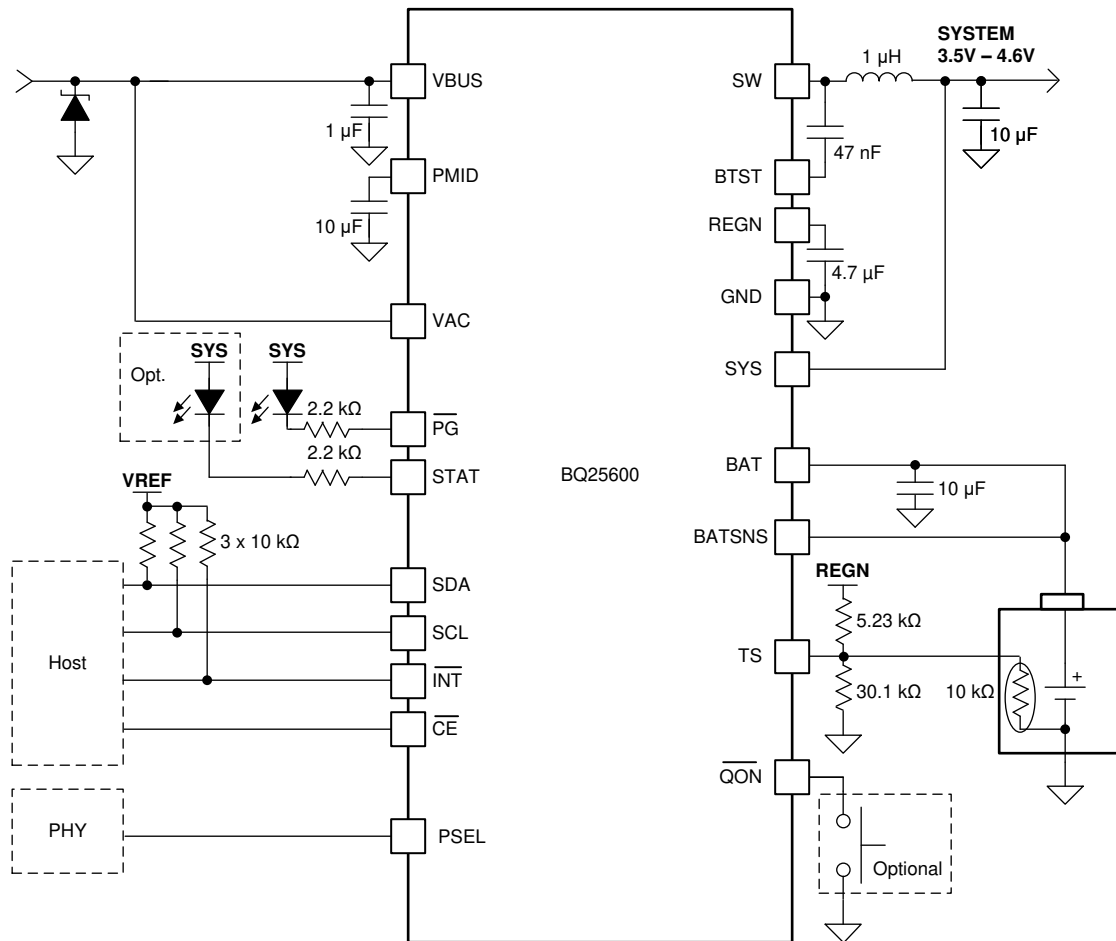

图 9-2. BQ25600D Applications Diagram

## 9.2.1 Design Requirements

表 9-1. Design Parameters

PARAMETER	VALUE
VBUS voltage range	4 V to 13.5 V
Input current limit (REG00[4:0])	3.2 A
Fast charge current limit (REG02[5:0])	2.4 A
Minimum system voltage (REG01[3:1])	3.5 V
Battery regulation voltage (REG04[7:3])	4.2 V

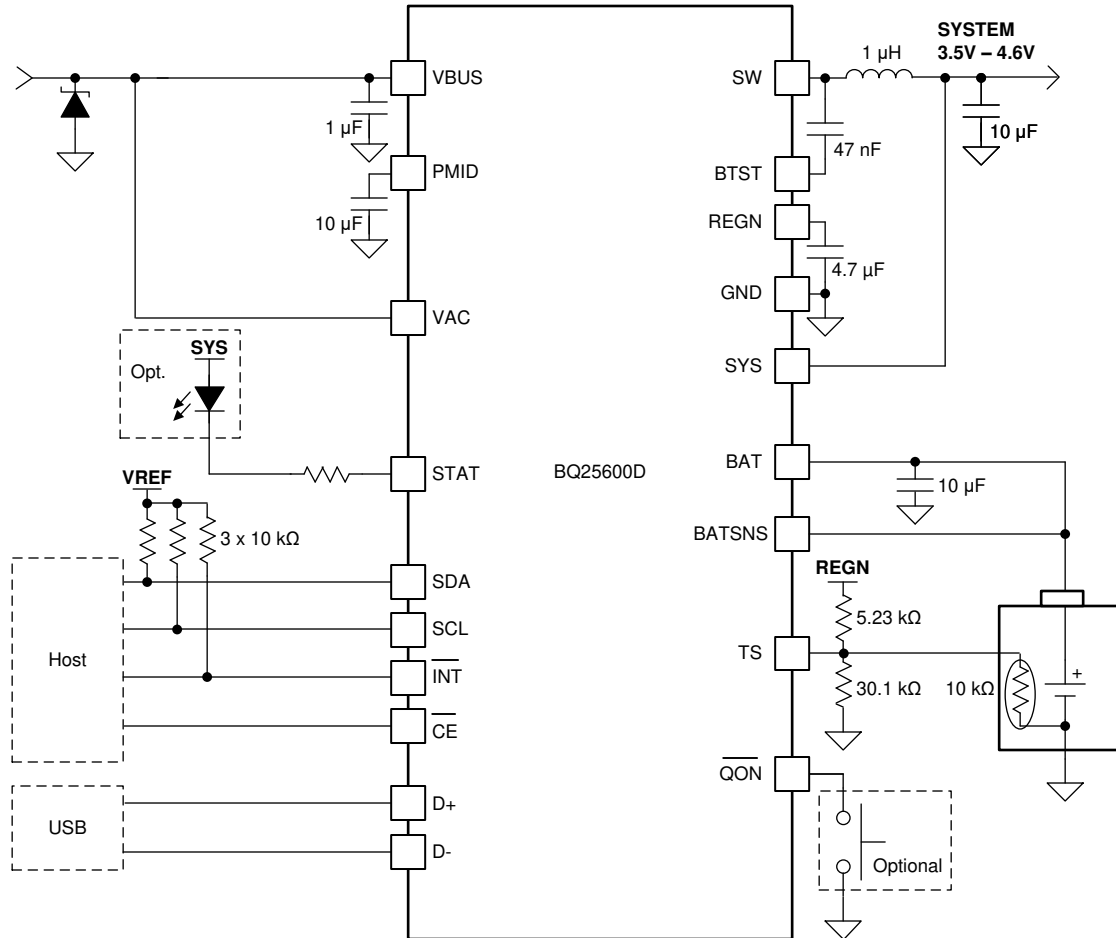
## 9.2.2 Detailed Design Procedure

### 9.2.2.1 Inductor Selection

The 1.5-MHz switching frequency allows the use of small inductor and capacitor values to maintain an inductor saturation current higher than the charging current ( $I_{CHG}$ ) plus half the ripple current ( $I_{RIPPLE}$ ):

$$I_{SAT} \geq I_{CHG} + (1/2) I_{RIPPLE} \quad (3)$$

The inductor ripple current depends on the input voltage ( $V_{VBUS}$ ), the duty cycle ( $D = V_{BAT}/V_{VBUS}$ ), the switching frequency ( $f_S$ ) and the inductance ( $L$ ).

$$I_{\text{RIPPLE}} = \frac{V_{\text{IN}} \times D \times (1 - D)}{f_s \times L} \quad (4)$$

The maximum inductor ripple current occurs when the duty cycle (D) is 0.5 or approximately 0.5. Usually inductor ripple is designed in the range between 20% and 40% maximum charging current as a trade-off between inductor size and efficiency for a practical design.

### 9.2.2.2 Input Capacitor

Design input capacitance to provide enough ripple current rating to absorb input switching ripple current. The worst case RMS ripple current is half of the charging current when duty cycle is 0.5. If the converter does not operate at 50% duty cycle, then the worst case capacitor RMS current  $I_{\text{CIN}}$  occurs where the duty cycle is closest to 50% and can be estimated using [方程式 5](#).

$$I_{\text{CIN}} = I_{\text{CHG}} \times \sqrt{D \times (1 - D)} \quad (5)$$

Low ESR ceramic capacitor such as X7R or X5R is preferred for input decoupling capacitor and should be placed to the drain of the high-side MOSFET and source of the low-side MOSFET as close as possible. Voltage rating of the capacitor must be higher than normal input voltage level. A rating of 25 V or higher capacitor is preferred for 15-V input voltage. Capacitance of 22  $\mu\text{F}$  is suggested for typical of 3-A charging current.

### 9.2.2.3 Output Capacitor

Ensure that the output capacitance has enough ripple current rating to absorb the output switching ripple current. [方程式 6](#) shows the output capacitor RMS current  $I_{\text{COUT}}$  calculation.

$$I_{\text{COUT}} = \frac{I_{\text{RIPPLE}}}{2 \times \sqrt{3}} \approx 0.29 \times I_{\text{RIPPLE}} \quad (6)$$

The output capacitor voltage ripple can be calculated as follows:

$$\Delta V_{\text{O}} = \frac{V_{\text{OUT}}}{8LCf_s^2} \left( 1 - \frac{V_{\text{OUT}}}{V_{\text{IN}}} \right) \quad (7)$$

At certain input and output voltage and switching frequency, the voltage ripple can be reduced by increasing the output filter LC.

The charger device has internal loop compensation optimized for >20- $\mu\text{F}$  ceramic output capacitance. The preferred ceramic capacitor is 10-V rating, X7R or X5R.

### 9.2.3 Application Curves

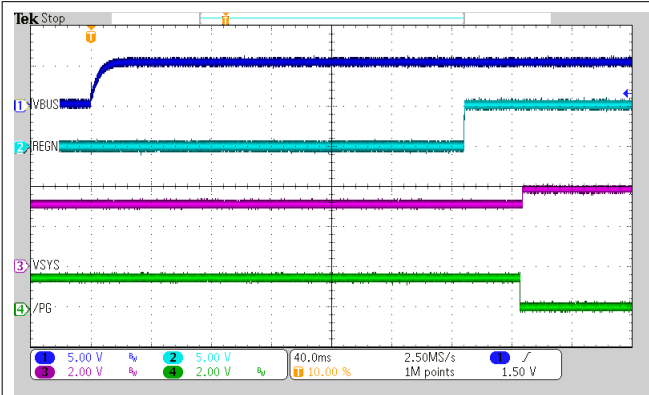

$V_{VBUS} = 5\text{ V}$   $V_{VBAT} = 3.2\text{ V}$

图 9-3. Power-Up with Charge Disabled

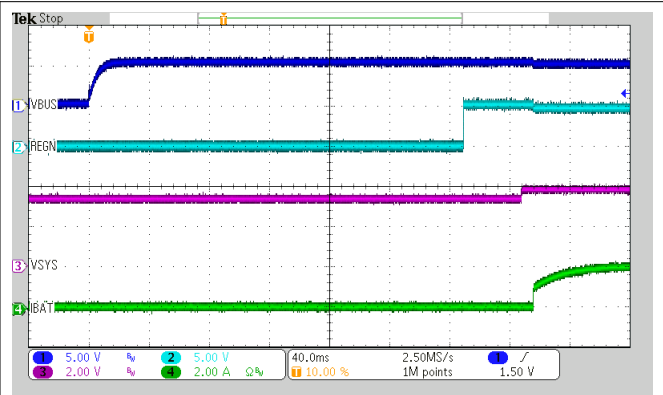

$V_{VBUS} = 5\text{ V}$   $V_{VBAT} = 3.2\text{ V}$   
 $I_{CHG} = 2\text{ A}$

图 9-4. Power-Up with Charge Enabled

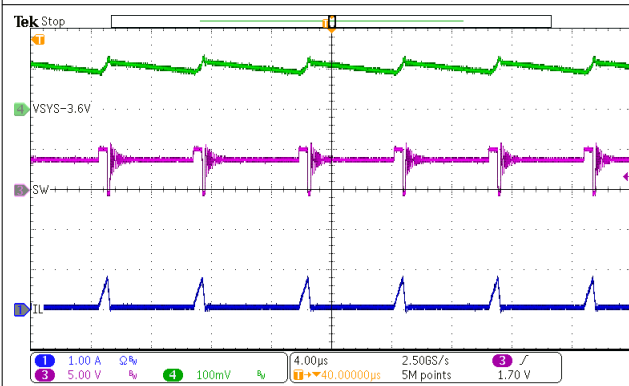

$V_{VBUS} = 5\text{ V}$   $I_{SYS} = 50\text{ mA}$  Charge Disabled

图 9-5. PFM Switching in Buck Mode

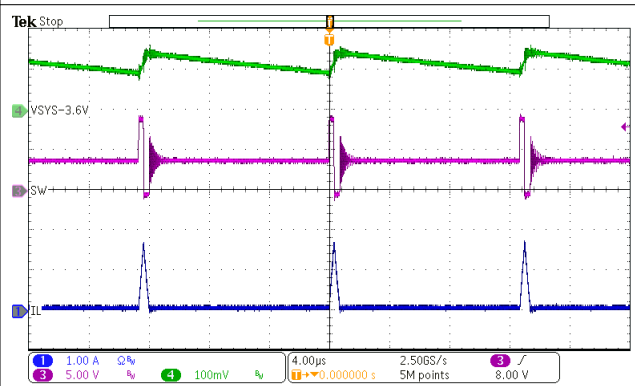

$V_{VBUS} = 9\text{ V}$   $I_{SYS} = 50\text{ mA}$  Charge Disabled

图 9-6. PFM Switching in Buck Mode

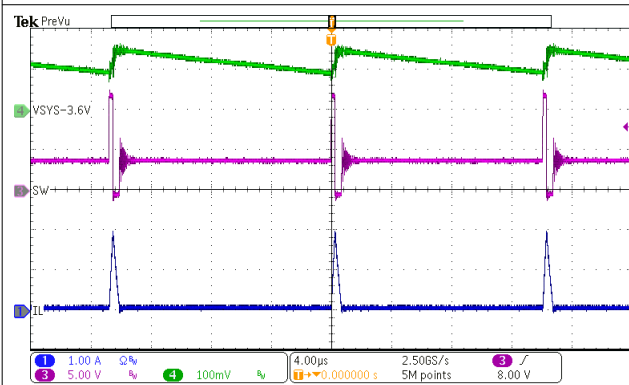

$V_{VBUS} = 12\text{ V}$   $I_{SYS} = 50\text{ mA}$  Charge Disabled

图 9-7. PFM Switching in Buck Mode

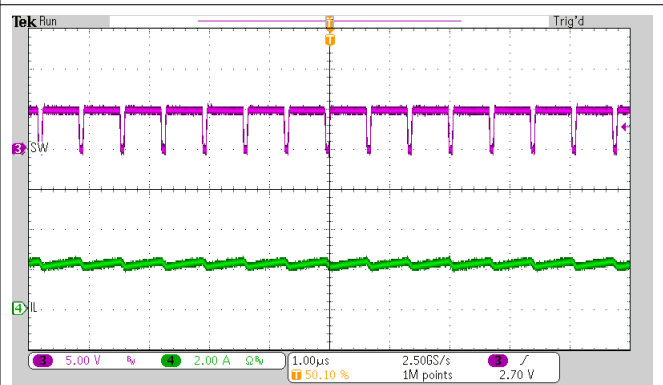

$V_{VBUS} = 5\text{ V}$   $V_{VBAT} = 3.8\text{ V}$   
 $I_{CHG} = 2\text{ A}$

图 9-8. PWM Switching in Buck Mode

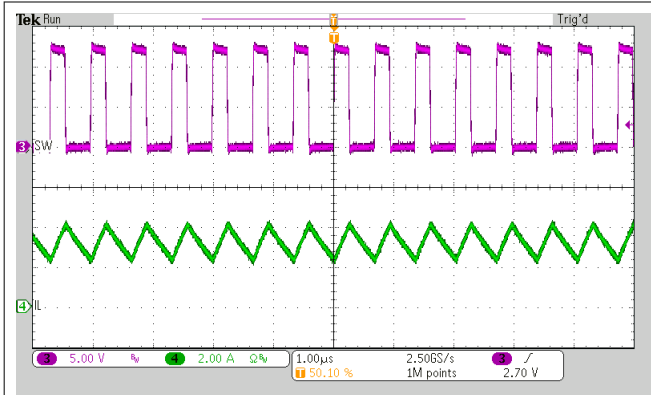

$V_{VBUS} = 12\text{ V}$                        $V_{VBAT} = 3.8\text{ V}$   
 $I_{CHG} = 2\text{ A}$

**图 9-9. PWM Switching in Buck mode**

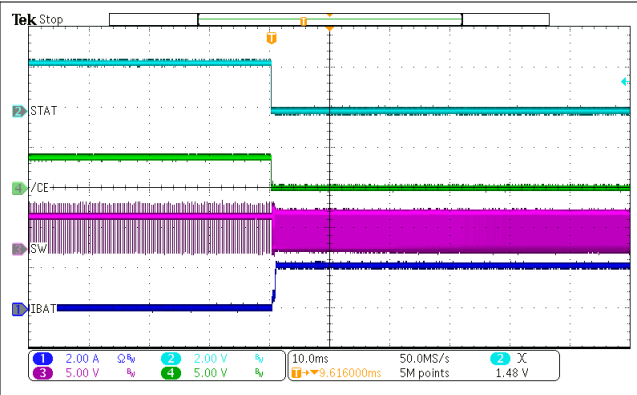

$V_{VBUS} = 5\text{ V}$                        $V_{VBAT} = 3.2\text{ V}$   
 $I_{CHG} = 2\text{ A}$

**图 9-10. Charge Enable**

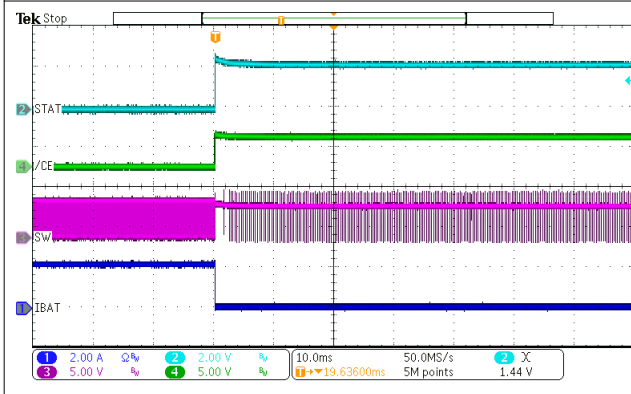

$V_{VBUS} = 5\text{ V}$                        $V_{VBAT} = 3.2\text{ V}$   
 $I_{CHG} = 2\text{ A}$

**图 9-11. Charge Disable**

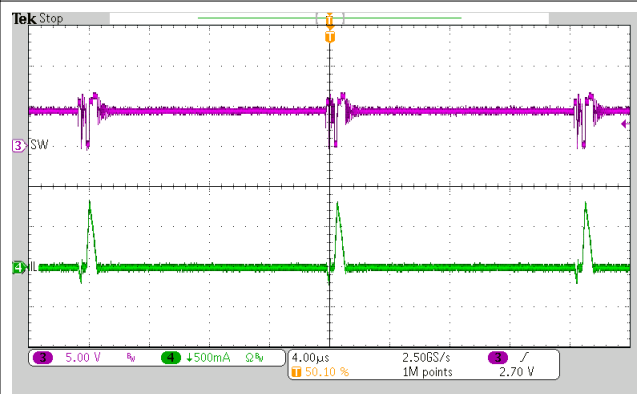

$V_{VBAT} = 4\text{ V}$                        $I_{LOAD} = 50\text{ mA}$                       PFM Enabled

**图 9-12. OTG Switching**

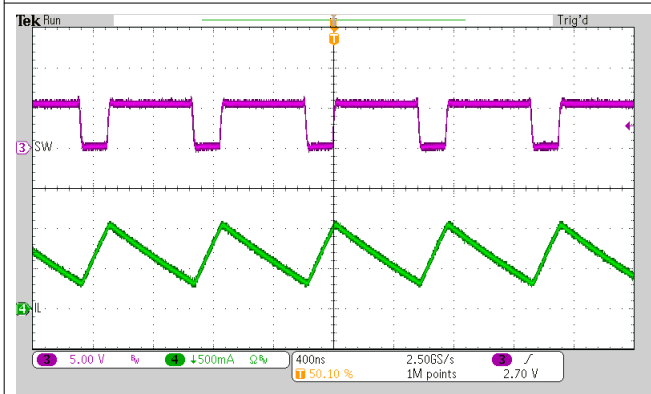

$V_{VBAT} = 4\text{ V}$                        $I_{LOAD} = 1\text{ A}$                       PFM Enabled

**图 9-13. OTG Switching**

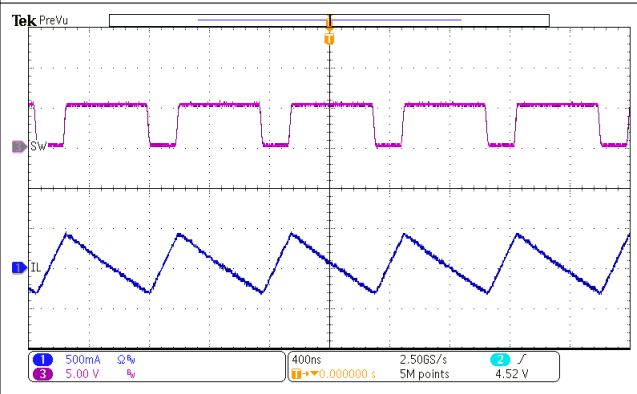

$V_{VBAT} = 4\text{ V}$                        $I_{LOAD} = 0\text{ A}$                       PFM Disabled

**图 9-14. OTG Switching**

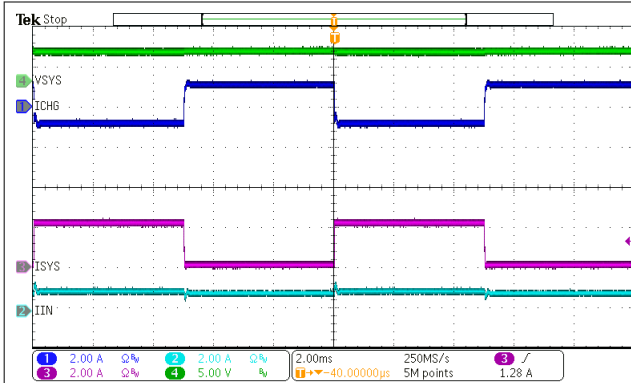

$V_{BUS} = 5\text{ V}$   
 $I_{SYS}$  from 0 A to 2 A  
 $V_{BAT} = 3.7\text{ V}$   
 $I_{INDPM} = 1\text{ A}$   
 $I_{CHG} = 1\text{ A}$

图 9-15. System Load Transient

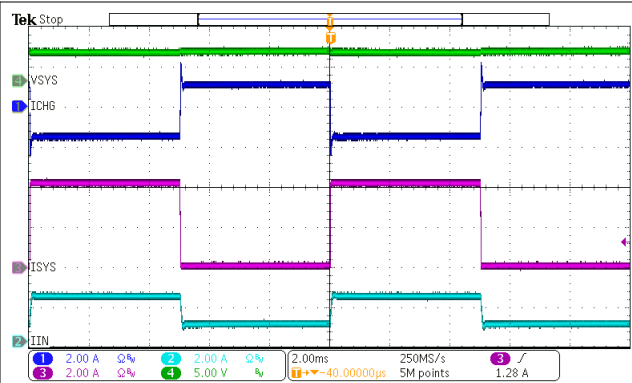

$V_{BUS} = 5\text{ V}$   
 $I_{SYS}$  from 0 A to 4 A  
 $V_{BAT} = 3.7\text{ V}$   
 $I_{INDPM} = 2\text{ A}$   
 $I_{CHG} = 1\text{ A}$

图 9-16. System Load Transient

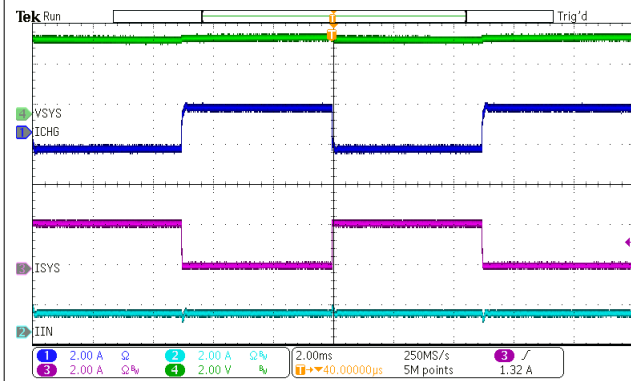

$V_{BUS} = 5\text{ V}$   
 $I_{SYS}$  from 0 A to 2 A  
 $V_{BAT} = 3.7\text{ V}$   
 $I_{INDPM} = 1\text{ A}$   
 $I_{CHG} = 2\text{ A}$

图 9-17. System Load Transient

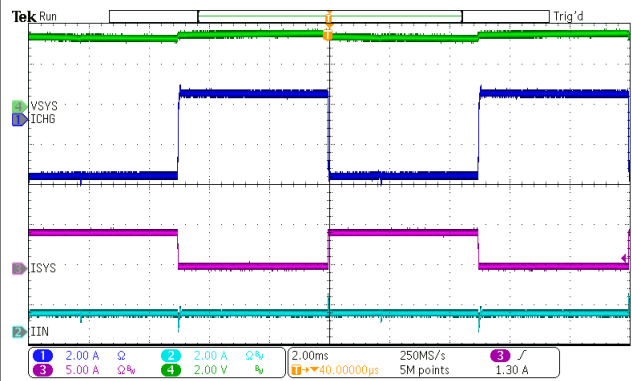

$V_{BUS} = 5\text{ V}$   
 $I_{SYS}$  from 0 A to 4 A  
 $V_{BAT} = 3.7\text{ V}$   
 $I_{INDPM} = 1\text{ A}$   
 $I_{CHG} = 2\text{ A}$

图 9-18. System Load Transient

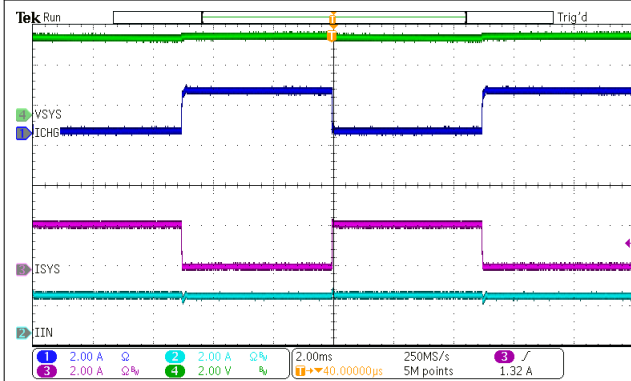

$V_{BUS} = 5\text{ V}$   
 $I_{SYS}$  from 0 A to 2 A  
 $V_{BAT} = 3.7\text{ V}$   
 $I_{INDPM} = 2\text{ A}$   
 $I_{CHG} = 2\text{ A}$

图 9-19. System Load Transient

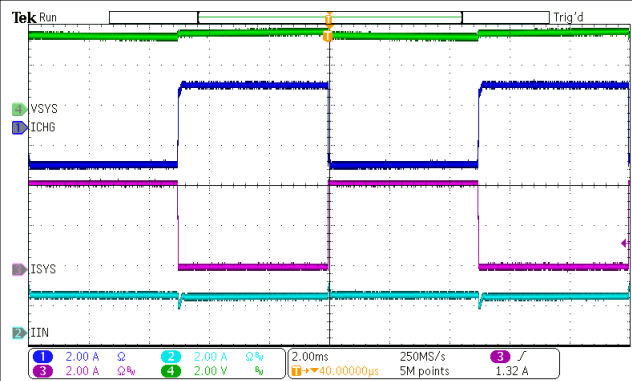

$V_{BUS} = 5\text{ V}$   
 $I_{SYS}$  from 0 A to 4 A  
 $V_{BAT} = 3.7\text{ V}$   
 $I_{INDPM} = 2\text{ A}$   
 $I_{CHG} = 2\text{ A}$

图 9-20. System Load Transient

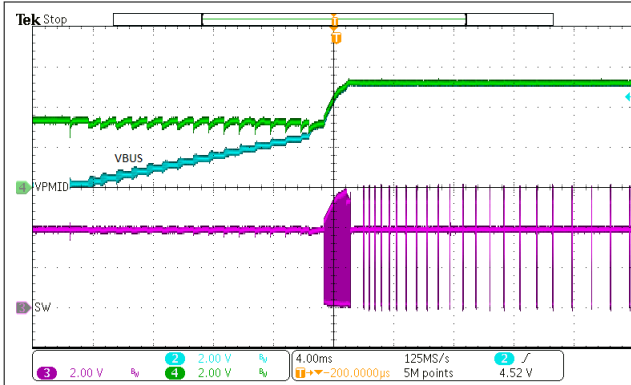

$V_{BAT} = 3.8\text{ V}$

$C_{LOAD} = 470\text{ }\mu\text{F}$

图 9-21. OTG Start-Up

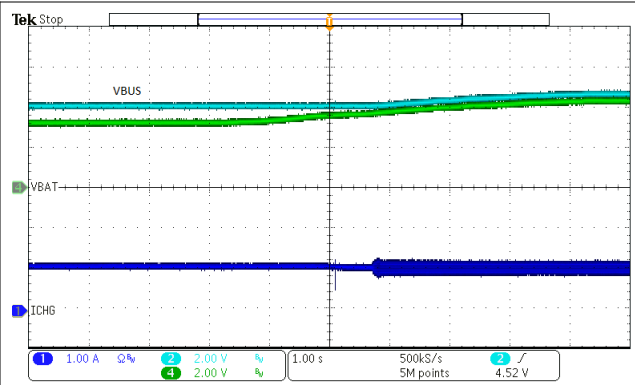

Adaptor  $I_{LIM} = 1\text{ A}$

图 9-22. VINDPM Tracking Battery Voltage

## 10 Power Supply Recommendations

In order to provide an output voltage on SYS, the BQ25600 and BQ25600D device requires a power supply between 3.9-V and 13.5-V input with at least 100-mA current rating connected to VBUS and a single-cell Li-Ion battery with voltage  $> V_{BATUVLO}$  connected to BAT. The source current rating needs to be at least 3 A in order for the buck converter of the charger to provide maximum output power to SYS.

## 11 Layout

### 11.1 Layout Guidelines

The switching node rise and fall times should be minimized for minimum switching loss. Proper layout of the components to minimize high frequency current path loop (see 图 11-1) is important to prevent electrical and magnetic field radiation and high frequency resonant problems.

#### 备注

It is essential to follow this specific layout PCB order.

1. Place input capacitor as close as possible to PMID pin and GND pin connections and use shortest copper trace connection or GND plane.
2. Put output capacitor near to the inductor and the IC.
3. Decoupling capacitors should be placed next to the IC pins and make trace connection as short as possible.
4. Place inductor input terminal to SW pin as close as possible. Minimize the copper area of this trace to lower electrical and magnetic field radiation but make the trace wide enough to carry the charging current. Do not use multiple layers in parallel for this connection. Minimize parasitic capacitance from this area to any other trace or plane.
5. It is OK to connect all grounds together to reduce PCB size and improve thermal dissipation.
6. Try to avoid ground planes in parallel with high frequency traces in other layers.

See the EVM design for the recommended component placement with trace and via locations.

### 11.2 Layout Example



图 11-1. High Frequency Current Path



## 12 Device and Documentation Support

### 12.1 Device Support

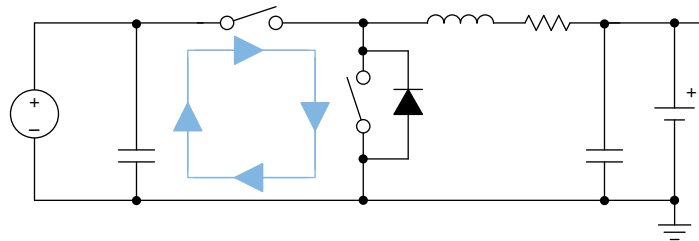
#### 12.1.1 第三方产品免责声明

TI 发布的与第三方产品或服务有关的信息，不能构成与此类产品或服务或保修的适用性有关的认可，不能构成此类产品或服务单独或与任何 TI 产品或服务一起的表示或认可。

#### 12.2 接收文档更新通知

要接收文档更新通知，请导航至 [ti.com](http://ti.com) 上的器件产品文件夹。点击 [订阅更新](#) 进行注册，即可每周接收产品信息更改摘要。有关更改的详细信息，请查看任何已修订文档中包含的修订历史记录。

#### 12.3 支持资源

[TI E2E™ 支持论坛](#) 是工程师的重要参考资料，可直接从专家获得快速、经过验证的解答和设计帮助。搜索现有解答或提出自己的问题可获得所需的快速设计帮助。

链接的内容由各个贡献者“按原样”提供。这些内容并不构成 TI 技术规范，并且不一定反映 TI 的观点；请参阅 TI 的 [《使用条款》](#)。

#### 12.4 Trademarks

TI E2E™ is a trademark of Texas Instruments.

所有商标均为其各自所有者的财产。

#### 12.5 Electrostatic Discharge Caution



This integrated circuit can be damaged by ESD. Texas Instruments recommends that all integrated circuits be handled with appropriate precautions. Failure to observe proper handling and installation procedures can cause damage.

ESD damage can range from subtle performance degradation to complete device failure. Precision integrated circuits may be more susceptible to damage because very small parametric changes could cause the device not to meet its published specifications.

#### 12.6 术语表

[TI 术语表](#) 本术语表列出并解释了术语、首字母缩略词和定义。

## 13 Mechanical, Packaging, and Orderable Information

The following pages include mechanical, packaging, and orderable information. This information is the most current data available for the designated devices. This data is subject to change without notice and revision of this document. For browser-based versions of this data sheet, refer to the left-hand navigation.

## PACKAGING INFORMATION

Orderable Device	Status (1)	Package Type	Package Drawing	Pins	Package Qty	Eco Plan (2)	Lead finish/ Ball material (6)	MSL Peak Temp (3)	Op Temp (°C)	Device Marking (4/5)	Samples
BQ25600DYFFR	ACTIVE	DSBGA	YFF	30	3000	RoHS & Green	SNAGCU	Level-1-260C-UNLIM	-40 to 85	BQ25600D	<a href="#">Samples</a>
BQ25600DYFFT	ACTIVE	DSBGA	YFF	30	250	RoHS & Green	SNAGCU	Level-1-260C-UNLIM	-40 to 85	BQ25600D	<a href="#">Samples</a>
BQ25600YFFR	ACTIVE	DSBGA	YFF	30	3000	RoHS & Green	SNAGCU	Level-1-260C-UNLIM	-40 to 85	BQ25600	<a href="#">Samples</a>
BQ25600YFFT	ACTIVE	DSBGA	YFF	30	250	RoHS & Green	SNAGCU	Level-1-260C-UNLIM	-40 to 85	BQ25600	<a href="#">Samples</a>

(1) The marketing status values are defined as follows:

**ACTIVE:** Product device recommended for new designs.

**LIFEBUY:** TI has announced that the device will be discontinued, and a lifetime-buy period is in effect.

**NRND:** Not recommended for new designs. Device is in production to support existing customers, but TI does not recommend using this part in a new design.

**PREVIEW:** Device has been announced but is not in production. Samples may or may not be available.

**OBSELETE:** TI has discontinued the production of the device.

(2) **RoHS:** TI defines "RoHS" to mean semiconductor products that are compliant with the current EU RoHS requirements for all 10 RoHS substances, including the requirement that RoHS substance do not exceed 0.1% by weight in homogeneous materials. Where designed to be soldered at high temperatures, "RoHS" products are suitable for use in specified lead-free processes. TI may reference these types of products as "Pb-Free".

**RoHS Exempt:** TI defines "RoHS Exempt" to mean products that contain lead but are compliant with EU RoHS pursuant to a specific EU RoHS exemption.

**Green:** TI defines "Green" to mean the content of Chlorine (Cl) and Bromine (Br) based flame retardants meet JS709B low halogen requirements of <=1000ppm threshold. Antimony trioxide based flame retardants must also meet the <=1000ppm threshold requirement.

(3) MSL, Peak Temp. - The Moisture Sensitivity Level rating according to the JEDEC industry standard classifications, and peak solder temperature.

(4) There may be additional marking, which relates to the logo, the lot trace code information, or the environmental category on the device.

(5) Multiple Device Markings will be inside parentheses. Only one Device Marking contained in parentheses and separated by a "-" will appear on a device. If a line is indented then it is a continuation of the previous line and the two combined represent the entire Device Marking for that device.

(6) Lead finish/Ball material - Orderable Devices may have multiple material finish options. Finish options are separated by a vertical ruled line. Lead finish/Ball material values may wrap to two lines if the finish value exceeds the maximum column width.

**Important Information and Disclaimer:**The information provided on this page represents TI's knowledge and belief as of the date that it is provided. TI bases its knowledge and belief on information provided by third parties, and makes no representation or warranty as to the accuracy of such information. Efforts are underway to better integrate information from third parties. TI has taken and

continues to take reasonable steps to provide representative and accurate information but may not have conducted destructive testing or chemical analysis on incoming materials and chemicals. TI and TI suppliers consider certain information to be proprietary, and thus CAS numbers and other limited information may not be available for release.

In no event shall TI's liability arising out of such information exceed the total purchase price of the TI part(s) at issue in this document sold by TI to Customer on an annual basis.

**TAPE AND REEL INFORMATION**

**QUADRANT ASSIGNMENTS FOR PIN 1 ORIENTATION IN TAPE**

\*All dimensions are nominal

Device	Package Type	Package Drawing	Pins	SPQ	Reel Diameter (mm)	Reel Width W1 (mm)	A0 (mm)	B0 (mm)	K0 (mm)	P1 (mm)	W (mm)	Pin1 Quadrant
BQ25600DYFFR	DSBGA	YFF	30	3000	180.0	8.4	2.09	2.59	0.78	4.0	8.0	Q1
BQ25600DYFFT	DSBGA	YFF	30	250	180.0	8.4	2.09	2.59	0.78	4.0	8.0	Q1
BQ25600YFFR	DSBGA	YFF	30	3000	180.0	8.4	2.09	2.59	0.78	4.0	8.0	Q1
BQ25600YFFT	DSBGA	YFF	30	250	180.0	8.4	2.09	2.59	0.78	4.0	8.0	Q1

## TAPE AND REEL BOX DIMENSIONS



\*All dimensions are nominal

Device	Package Type	Package Drawing	Pins	SPQ	Length (mm)	Width (mm)	Height (mm)
BQ25600DYFFR	DSBGA	YFF	30	3000	210.0	185.0	35.0
BQ25600DYFFT	DSBGA	YFF	30	250	210.0	185.0	35.0
BQ25600YFFR	DSBGA	YFF	30	3000	210.0	185.0	35.0
BQ25600YFFT	DSBGA	YFF	30	250	210.0	185.0	35.0

YFF0030

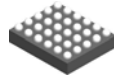

PACKAGE OUTLINE

DSBGA - 0.625 mm max height

DIE SIZE BALL GRID ARRAY

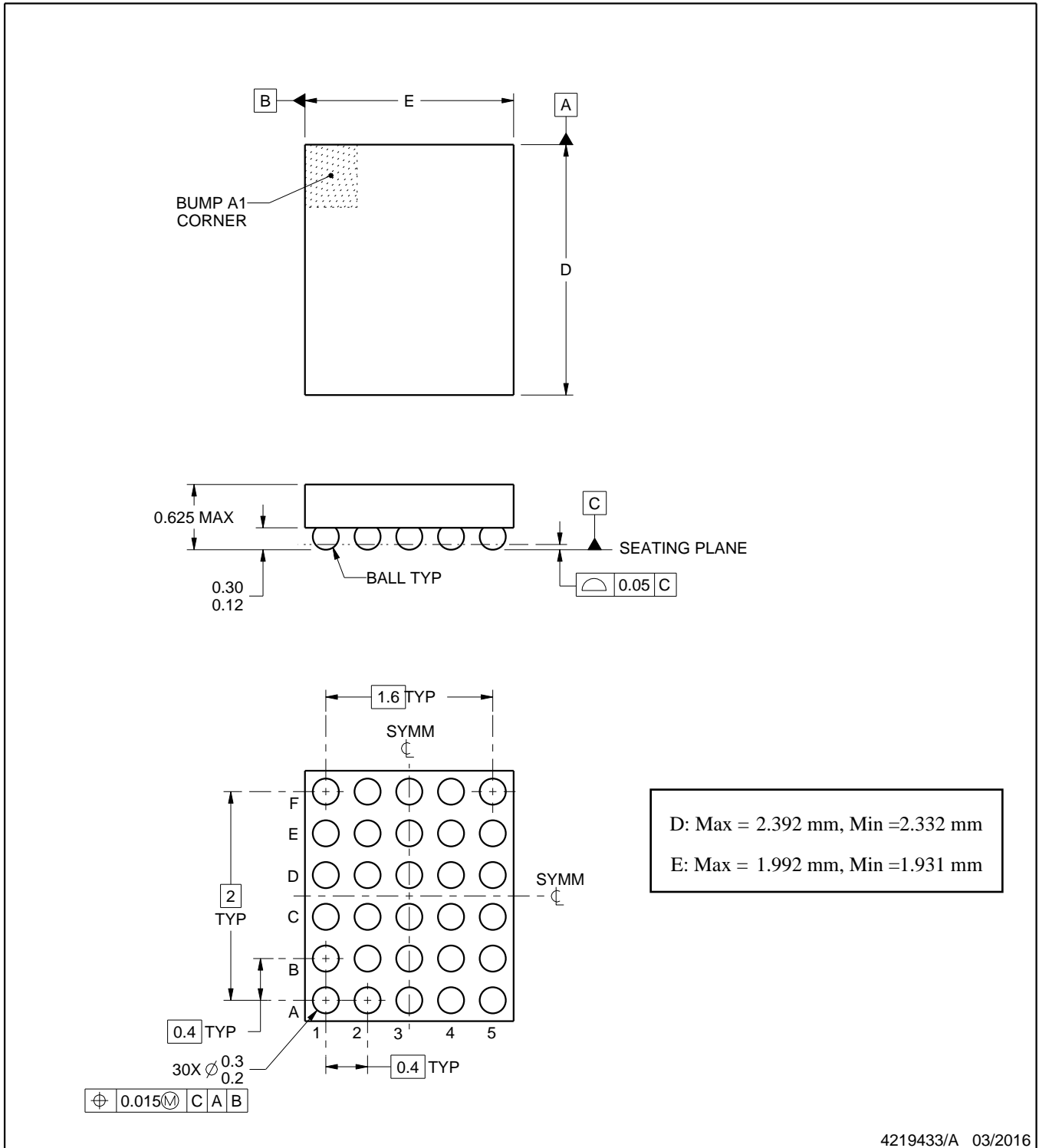

NOTES:

1. All linear dimensions are in millimeters. Any dimensions in parenthesis are for reference only. Dimensioning and tolerancing per ASME Y14.5M.
2. This drawing is subject to change without notice.

# EXAMPLE BOARD LAYOUT

YFF0030

DSBGA - 0.625 mm max height

DIE SIZE BALL GRID ARRAY

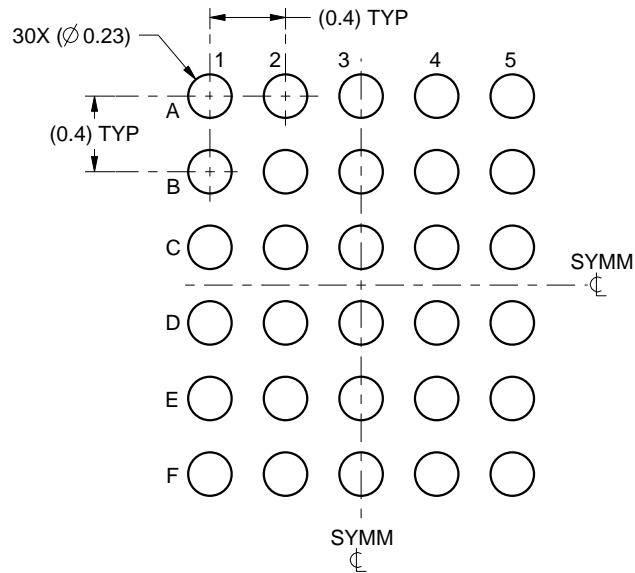

LAND PATTERN EXAMPLE  
SCALE:25X

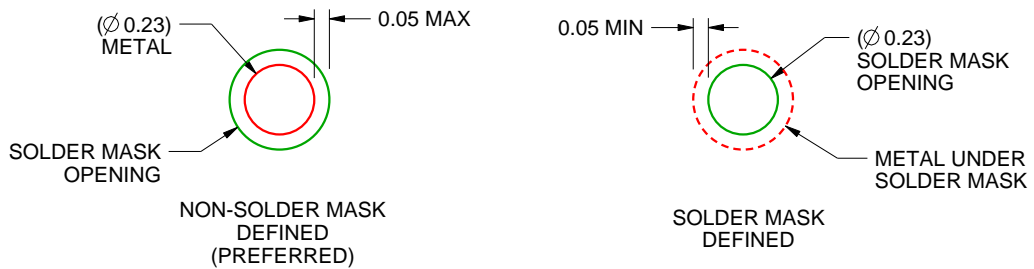

SOLDER MASK DETAILS  
NOT TO SCALE

4219433/A 03/2016

NOTES: (continued)

- Final dimensions may vary due to manufacturing tolerance considerations and also routing constraints. For more information, see Texas Instruments literature number SNVA009 ([www.ti.com/lit/snva009](http://www.ti.com/lit/snva009)).



# EXAMPLE STENCIL DESIGN

YFF0030

DSBGA - 0.625 mm max height

DIE SIZE BALL GRID ARRAY

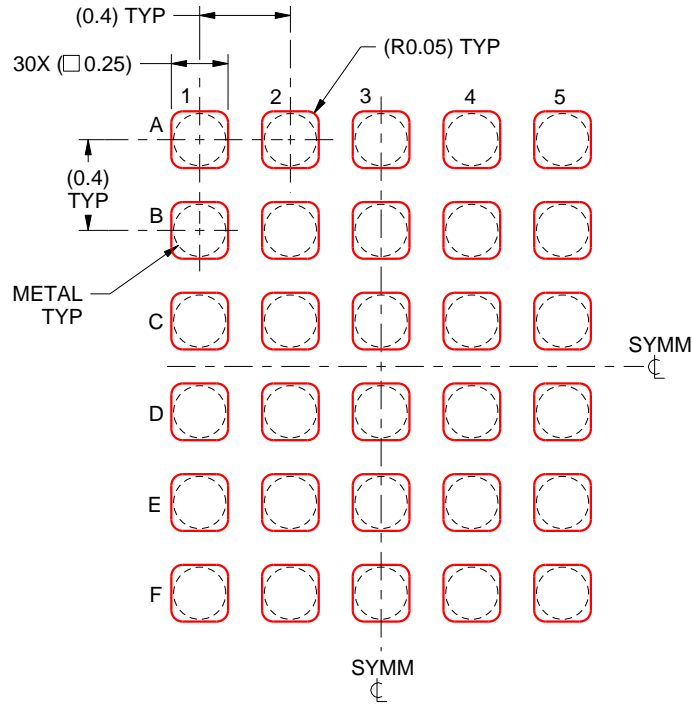

SOLDER PASTE EXAMPLE  
BASED ON 0.1 mm THICK STENCIL  
SCALE:30X

4219433/A 03/2016

NOTES: (continued)

4. Laser cutting apertures with trapezoidal walls and rounded corners may offer better paste release.

## 重要声明和免责声明

TI“按原样”提供技术和可靠性数据（包括数据表）、设计资源（包括参考设计）、应用或其他设计建议、网络工具、安全信息和其他资源，不保证没有瑕疵且不做任何明示或暗示的担保，包括但不限于对适销性、某特定用途方面的适用性或不侵犯任何第三方知识产权的暗示担保。

这些资源可供使用 TI 产品进行设计的熟练开发人员使用。您将自行承担以下全部责任：(1) 针对您的应用选择合适的 TI 产品，(2) 设计、验证并测试您的应用，(3) 确保您的应用满足相应标准以及任何其他功能安全、信息安全、监管或其他要求。

这些资源如有变更，恕不另行通知。TI 授权您仅可将这些资源用于研发本资源所述的 TI 产品的应用。严禁对这些资源进行其他复制或展示。您无权使用任何其他 TI 知识产权或任何第三方知识产权。您应全额赔偿因在这些资源的使用中对 TI 及其代表造成的任何索赔、损害、成本、损失和债务，TI 对此概不负责。

TI 提供的产品受 [TI 的销售条款](#) 或 [ti.com](#) 上其他适用条款/TI 产品随附的其他适用条款的约束。TI 提供这些资源并不会扩展或以其他方式更改 TI 针对 TI 产品发布的适用的担保或担保免责声明。

TI 反对并拒绝您可能提出的任何其他或不同的条款。

邮寄地址：Texas Instruments, Post Office Box 655303, Dallas, Texas 75265

Copyright © 2023，德州仪器 (TI) 公司