

# CSD22205L -8V P 沟道 NexFET™ 功率 MOSFET

## 1 特性

- 低电阻
- 1.2mm × 1.2mm 小尺寸封装
- 0.36mm 厚，超薄型
- 无铅
- 栅源电压钳位
- 栅极 ESD 保护
- 符合 RoHS
- 无卤素

## 2 应用

- 电池管理
- 负载开关
- 电池保护

## 3 说明

这款 -8V、8.2mΩ、1.2mm × 1.2mm 基板栅格阵列 (LGA) NexFET™ 器件设计用于在超薄且具有出色散热特性的超小外形尺寸封装内提供更低的导通电阻和栅极电荷。基板栅格阵列 (LGA) 封装是一种带有金属接触板 (而非焊球) 的器件芯片级封装。

### 产品概要

T <sub>A</sub> = 25°C		值	单位
V <sub>DS</sub>	漏源电压	-8	V
Q <sub>g</sub>	栅极电荷总量 (-4.5V)	6.5	nC
Q <sub>gd</sub>	栅极电荷 (栅极到漏极)	1.0	nC
R <sub>DS(on)</sub>	漏源导通电阻	V <sub>GS</sub> = -1.5V	30
		V <sub>GS</sub> = -1.8V	20
		V <sub>GS</sub> = -2.5V	11.5
		V <sub>GS</sub> = -4.5V	8.2
V <sub>GS(th)</sub>	阈值电压	-0.7	V

### 器件信息(1)

器件	数量	介质	封装	配送
CSD22205L	3000	7 英寸卷带	1.20mm × 1.20mm 基板栅格阵列 封装	卷带包装
CSD22205LT	250			

(1) 如需了解所有可用封装，请参阅数据表末尾的可订购产品附录。

### 绝对最大额定值

T <sub>A</sub> = 25°C		值	单位
V <sub>DS</sub>	漏源电压	-8	V
V <sub>GS</sub>	栅源电压	-6	V
I <sub>D</sub>	持续漏极电流(1)	-7.4	A
I <sub>DM</sub>	脉冲漏极电流(2)	-71	A
P <sub>D</sub>	功率耗散(1)	0.6	W
T <sub>J</sub> 、 T <sub>stg</sub>	工作结温， 贮存温度	-55 至 150	°C

(1) R<sub>θJA</sub> = 225°C/W (覆铜面积最小时的值)。

(2) 脉宽 ≤ 100 μs，占空比 ≤ 1%。

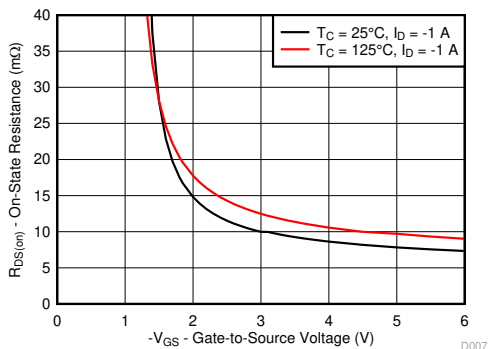

R<sub>DS(on)</sub> 与 V<sub>GS</sub> 之间的关系

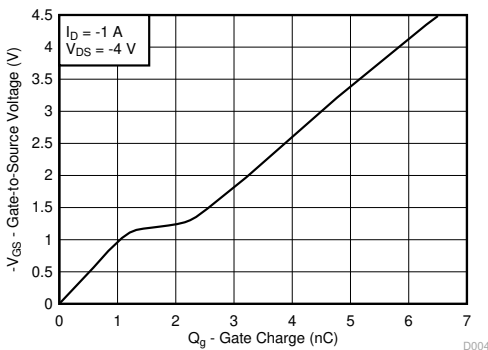

R<sub>DS(on)</sub> 与 V<sub>GS</sub> 之间的关系



图 3-1. 顶视图和电路配置



## Table of Contents

<b>1 特性</b> .....	<b>1</b>	<b>6 Device and Documentation Support</b> .....	<b>7</b>
<b>2 应用</b> .....	<b>1</b>	6.1 Receiving Notification of Documentation Updates.....	7
<b>3 说明</b> .....	<b>1</b>	6.2 Trademarks.....	7
<b>4 Revision History</b> .....	<b>2</b>	<b>7 Mechanical, Packaging, and Orderable Information</b> ....	<b>8</b>
<b>5 Specifications</b> .....	<b>3</b>	7.1 CSD22205L Package Dimensions.....	8
5.1 Electrical Characteristics.....	3	7.2 Land Pattern Recommendation.....	9
5.2 Thermal Information.....	4	7.3 Stencil Recommendation.....	9
5.3 Typical MOSFET Characteristics.....	4		

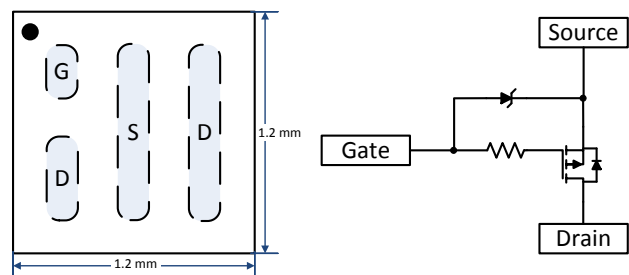
## 4 Revision History

<b>Changes from Revision A (August 2017) to Revision B (February 2022)</b>	<b>Page</b>
• 将超薄型封装要点中的厚度从 0.35mm 更改为 0.36mm.....	1
• Changed CSD22205L Package Dimensions image height from 0.35 mm to 0.36 mm.....	8

<b>Changes from Revision * (May 2017) to Revision A (August 2017)</b>	<b>Page</b>
• Changed the units for timing parameters from $\mu$ s : to ns (nanoseconds) in the <a href="#">节 5.1</a> table.....	3

## 5 Specifications

### 5.1 Electrical Characteristics

T<sub>A</sub> = 25°C (unless otherwise stated)

PARAMETER		TEST CONDITIONS	MIN	TYP	MAX	UNIT
<b>STATIC CHARACTERISTICS</b>						
B <sub>V</sub> DSS	Drain-to-source voltage	V <sub>GS</sub> = 0 V, I <sub>D</sub> = - 250 μA	- 8			V
I <sub>DSS</sub>	Drain-to-source leakage current	V <sub>GS</sub> = 0 V, V <sub>DS</sub> = - 6.4 V			- 100	nA
I <sub>GSS</sub>	Gate-to-source leakage current	V <sub>DS</sub> = 0 V, V <sub>GS</sub> = - 6 V			- 100	nA
V <sub>GS(th)</sub>	Gate-to-source threshold voltage	V <sub>DS</sub> = V <sub>GS</sub> , I <sub>D</sub> = - 250 μA	- 0.4	- 0.7	- 1.05	V
R <sub>DS(on)</sub>	Drain-to-source on-resistance	V <sub>GS</sub> = - 1.5 V, I <sub>D</sub> = - 0.2 A		30		mΩ
		V <sub>GS</sub> = - 1.8 V, I <sub>D</sub> = - 1 A		20	40	
		V <sub>GS</sub> = - 2.5 V, I <sub>D</sub> = - 1 A		11.5	15.0	
		V <sub>GS</sub> = - 4.5 V, I <sub>D</sub> = - 1 A		8.2	9.9	
g <sub>fs</sub>	Transconductance	V <sub>DS</sub> = - 0.8 V, I <sub>D</sub> = - 1 A		10.4		S
<b>DYNAMIC CHARACTERISTICS</b>						
C <sub>ISS</sub>	Input capacitance	V <sub>GS</sub> = 0 V, V <sub>DS</sub> = - 4 V, f = 1 MHz		1070	1390	pF
C <sub>OSS</sub>	Output capacitance			560	730	pF
C <sub>RSS</sub>	Reverse transfer capacitance			190	250	pF
R <sub>G</sub>	Series gate resistance			30		Ω
Q <sub>g</sub>	Gate charge total ( - 4.5 V)	V <sub>DS</sub> = - 4 V, I <sub>D</sub> = - 1 A		6.5	8.5	nC
Q <sub>gd</sub>	Gate charge gate-to-drain			1.0		nC
Q <sub>gs</sub>	Gate charge gate-to-source			1.2		nC
Q <sub>g(th)</sub>	Gate charge at V <sub>th</sub>			0.7		nC
Q <sub>OSS</sub>	Output charge	V <sub>DS</sub> = - 4 V, V <sub>GS</sub> = 0 V		4.1		nC
t <sub>d(on)</sub>	Turnon delay time	V <sub>DS</sub> = - 4 V, V <sub>GS</sub> = - 4.5 V, I <sub>D</sub> = - 1 A, R <sub>G</sub> = 0 Ω		30		ns
t <sub>r</sub>	Rise time			14		ns
t <sub>d(off)</sub>	Turnoff delay time			70		ns
t <sub>f</sub>	Fall time			32		ns
<b>DIODE CHARACTERISTICS</b>						
V <sub>SD</sub>	Diode forward voltage	I <sub>S</sub> = - 1 A, V <sub>GS</sub> = 0 V		- 0.68	- 1.0	V
Q <sub>rr</sub>	Reverse recovery charge	V <sub>DS</sub> = - 4 V, I <sub>F</sub> = - 1 A,		16		nC
t <sub>rr</sub>	Reverse recovery time	di/dt = 200 A/μs		38		ns

### 5.2 Thermal Information

T<sub>A</sub> = 25°C (unless otherwise stated)

THERMAL METRIC		MIN	TYP	MAX	UNIT
R <sub>θJA</sub>	Junction-to-ambient thermal resistance <sup>(2)</sup>		75		°C/W
	Junction-to-ambient thermal resistance <sup>(1)</sup>		225		

- (1) Device mounted on FR4 material with minimum Cu mounting area.
- (2) Device mounted on FR4 material with 1-in<sup>2</sup> (6.45-cm<sup>2</sup>), 2-oz (0.071-mm) thick Cu.

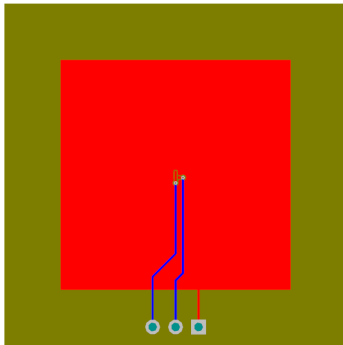

Typ R<sub>θJA</sub> = 75°C/W when mounted on 1 in<sup>2</sup> of 2-oz Cu.

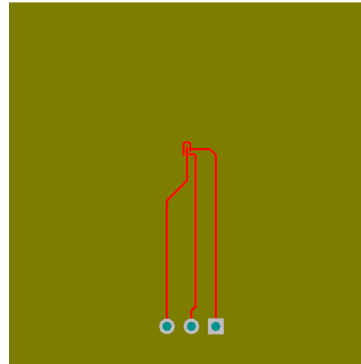

Typ R<sub>θJA</sub> = 225°C/W when mounted on minimum pad area of 2-oz Cu.

### 5.3 Typical MOSFET Characteristics

T<sub>A</sub> = 25°C (unless otherwise stated)

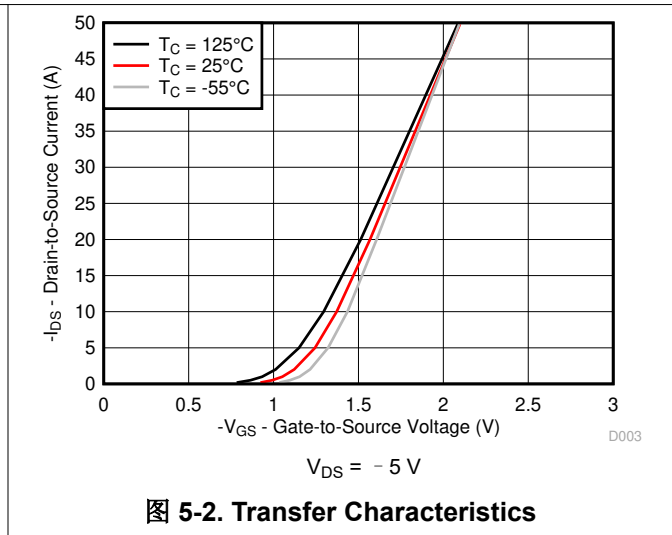
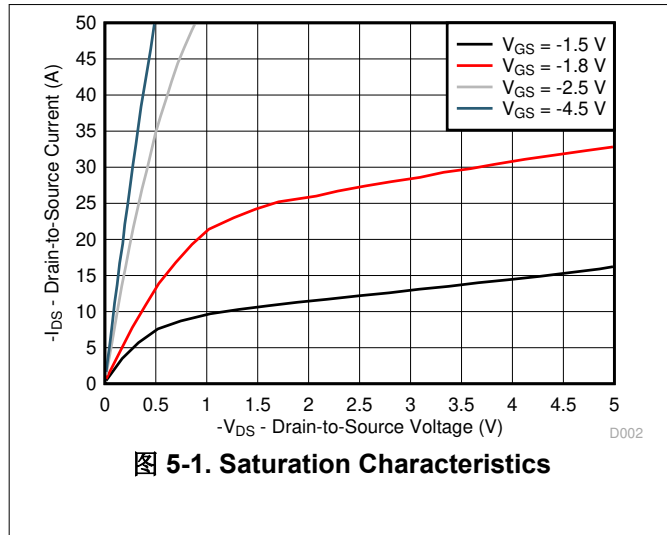



图 5-3. Maximum Drain Current vs Temperature



图 5-4. Gate Charge

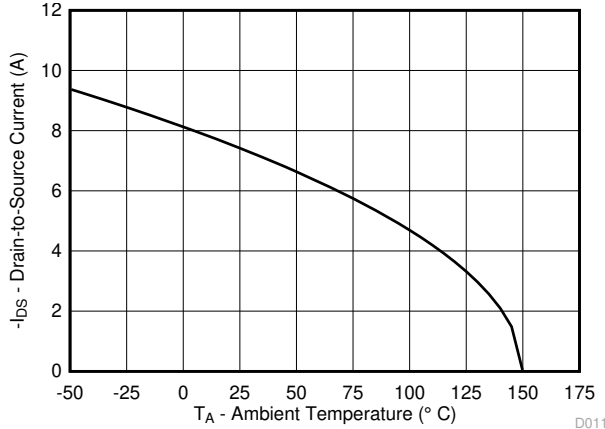

图 5-5. Capacitance

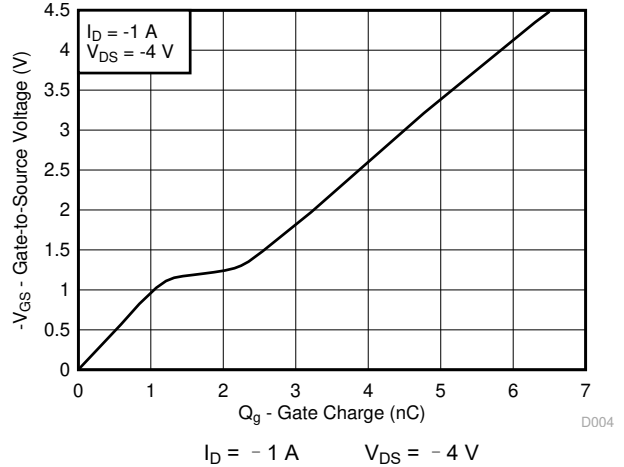

图 5-6. Threshold Voltage vs Temperature

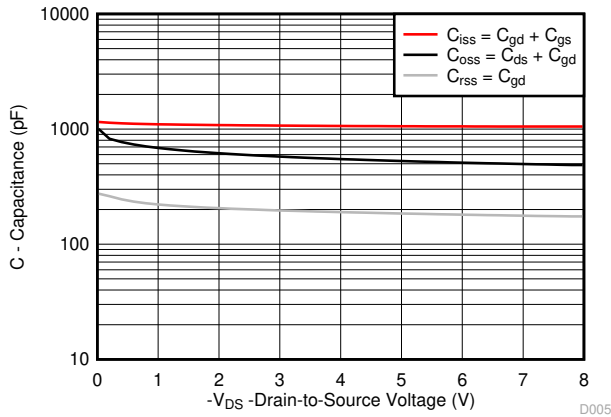

图 5-7. On-State Resistance vs Gate-to-Source Voltage

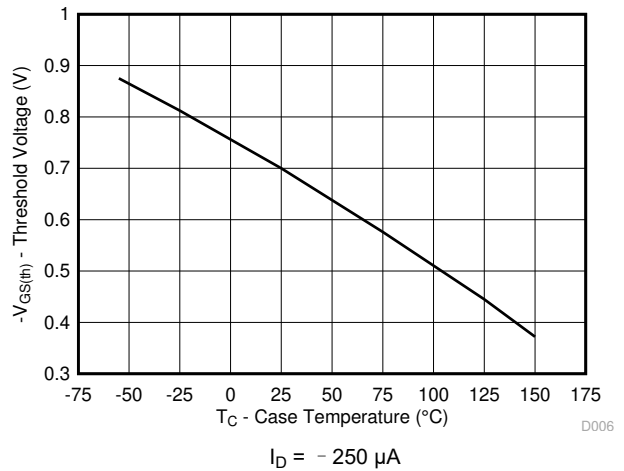

图 5-8. Normalized On-State Resistance vs Temperature

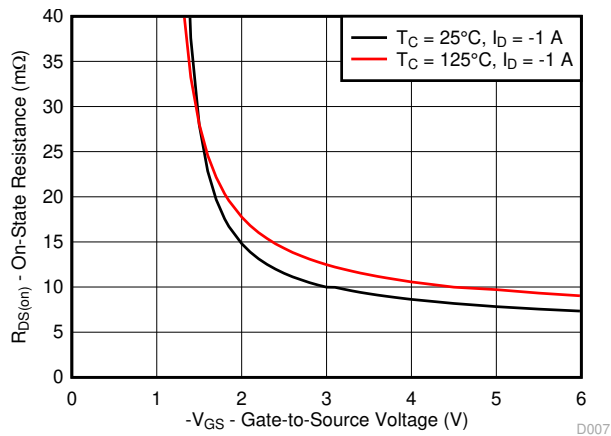

图 5-9. Typical Diode Forward Voltage

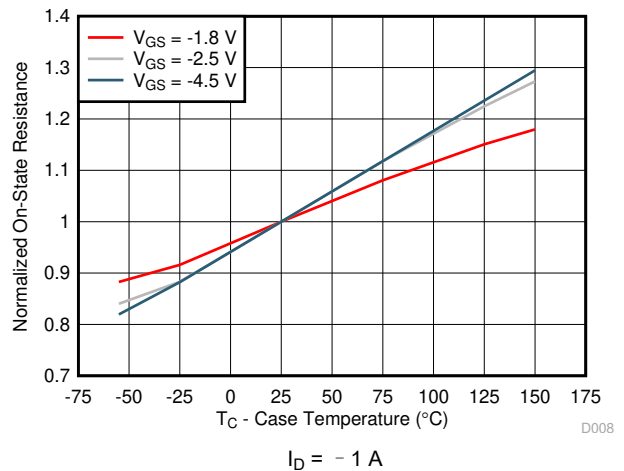

图 5-10. Maximum Safe Operating Area

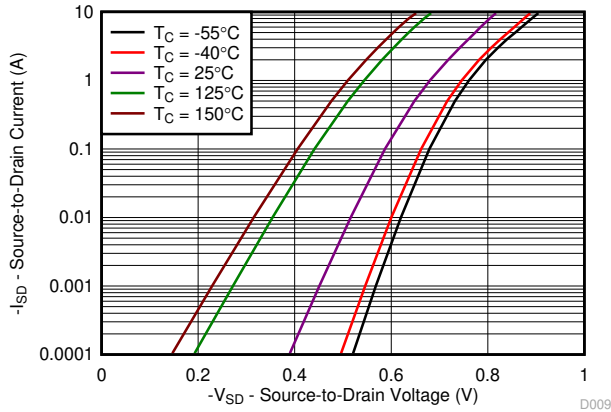

图 5-11. Transient Thermal Impedance

## 6 Device and Documentation Support

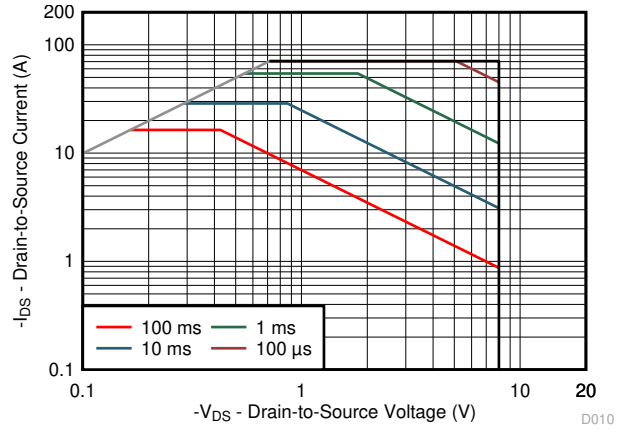
### 6.1 Receiving Notification of Documentation Updates

To receive notification of documentation updates, navigate to the device product folder on ti.com. In the upper right corner, click on *Alert me* to register and receive a weekly digest of any product information that has changed. For change details, review the revision history included in any revised document.

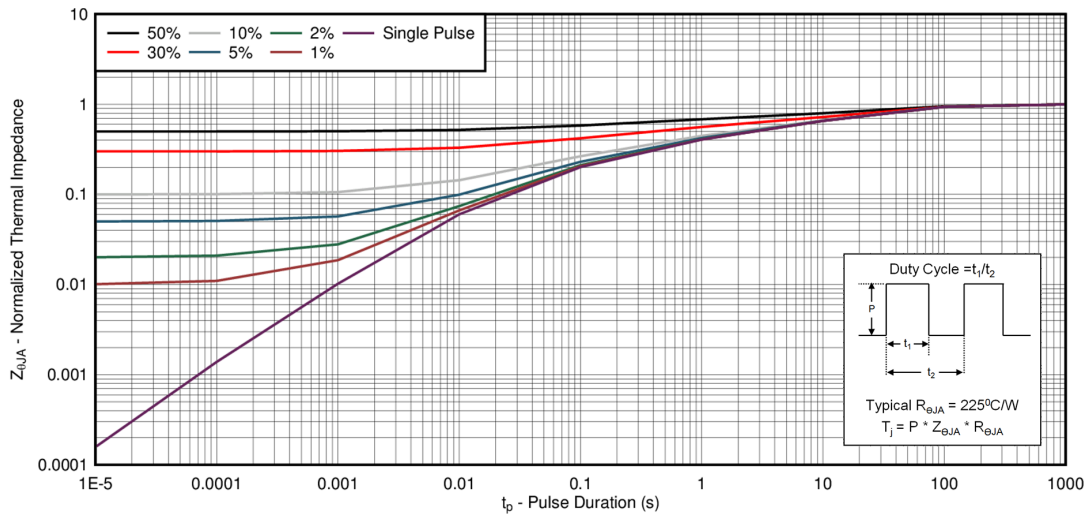
### 6.2 Trademarks

NexFET™ is a trademark of Texas Instruments.

所有商标均为其各自所有者的财产。

## 7 Mechanical, Packaging, and Orderable Information

The following pages include mechanical, packaging, and orderable information. This information is the most current data available for the designated devices. This data is subject to change without notice and revision of this document. For browser-based versions of this data sheet, refer to the left-hand navigation.

### 7.1 CSD22205L Package Dimensions

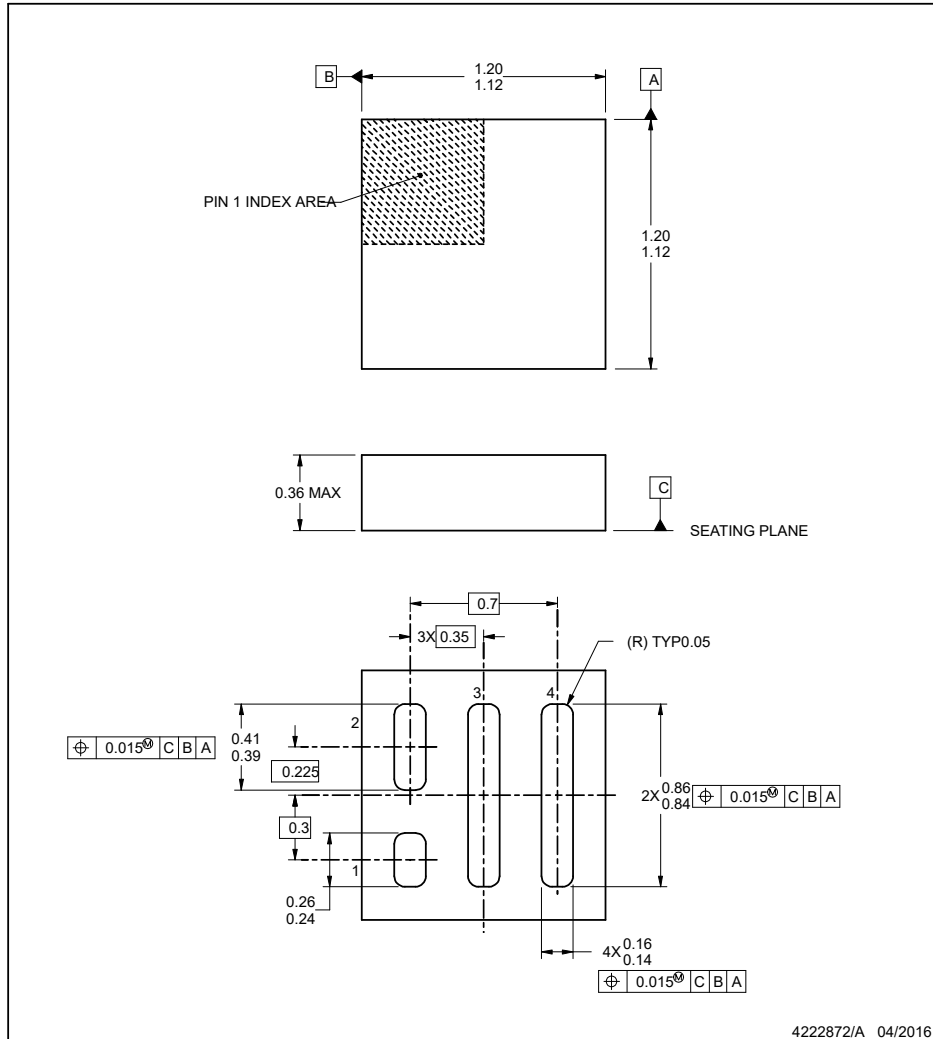

1. All linear dimensions are in millimeters. Any dimensions in parenthesis are for reference only. Dimensioning and tolerancing per ASME Y14.5M.
2. This drawing is subject to change without notice.
3. This package is a lead-free bump design. Bump finish may vary. To determine the exact finish, refer to the device data sheet or contact a local TI representative.

表 7-1. Pin Configuration Table

POSITION	DESIGNATION
1	Gate
2	Drain
3	Source
4	Drain



## 7.2 Land Pattern Recommendation

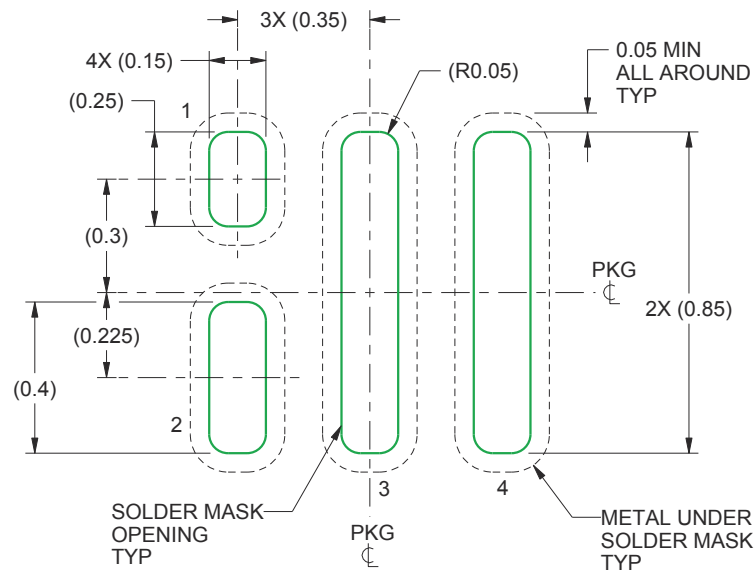

## 7.3 Stencil Recommendation

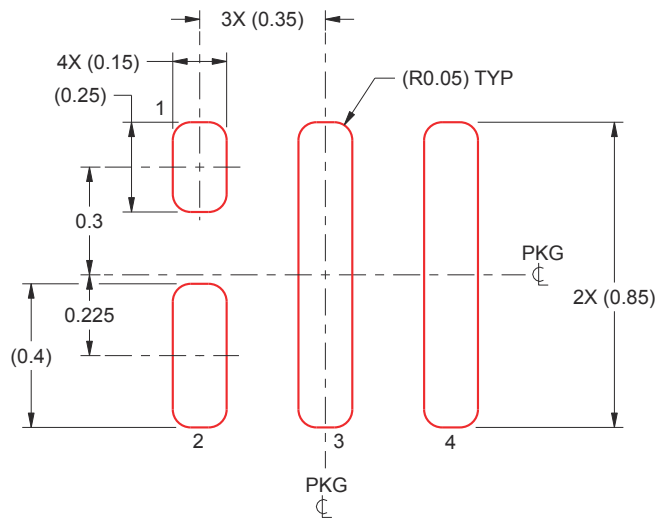

- A. Laser cutting apertures with trapezoidal walls and rounded corners may offer better paste release. IPC-7525 may have alternate design recommendations.

**PACKAGING INFORMATION**

Orderable Device	Status (1)	Package Type	Package Drawing	Pins	Package Qty	Eco Plan (2)	Lead finish/ Ball material (6)	MSL Peak Temp (3)	Op Temp (°C)	Device Marking (4/5)	Samples
CSD22205L	ACTIVE	PICOSTAR	YMG	4	3000	RoHS & Green	NIAU	Level-1-260C-UNLIM	-55 to 150	205	<a href="#">Samples</a>
CSD22205LT	ACTIVE	PICOSTAR	YMG	4	250	RoHS & Green	NIAU	Level-1-260C-UNLIM	-55 to 150	205	<a href="#">Samples</a>

(1) The marketing status values are defined as follows:

**ACTIVE:** Product device recommended for new designs.

**LIFEBUY:** TI has announced that the device will be discontinued, and a lifetime-buy period is in effect.

**NRND:** Not recommended for new designs. Device is in production to support existing customers, but TI does not recommend using this part in a new design.

**PREVIEW:** Device has been announced but is not in production. Samples may or may not be available.

**OBSOLETE:** TI has discontinued the production of the device.

(2) **RoHS:** TI defines "RoHS" to mean semiconductor products that are compliant with the current EU RoHS requirements for all 10 RoHS substances, including the requirement that RoHS substance do not exceed 0.1% by weight in homogeneous materials. Where designed to be soldered at high temperatures, "RoHS" products are suitable for use in specified lead-free processes. TI may reference these types of products as "Pb-Free".

**RoHS Exempt:** TI defines "RoHS Exempt" to mean products that contain lead but are compliant with EU RoHS pursuant to a specific EU RoHS exemption.

**Green:** TI defines "Green" to mean the content of Chlorine (Cl) and Bromine (Br) based flame retardants meet JS709B low halogen requirements of <=1000ppm threshold. Antimony trioxide based flame retardants must also meet the <=1000ppm threshold requirement.

(3) MSL, Peak Temp. - The Moisture Sensitivity Level rating according to the JEDEC industry standard classifications, and peak solder temperature.

(4) There may be additional marking, which relates to the logo, the lot trace code information, or the environmental category on the device.

(5) Multiple Device Markings will be inside parentheses. Only one Device Marking contained in parentheses and separated by a "~" will appear on a device. If a line is indented then it is a continuation of the previous line and the two combined represent the entire Device Marking for that device.

(6) Lead finish/Ball material - Orderable Devices may have multiple material finish options. Finish options are separated by a vertical ruled line. Lead finish/Ball material values may wrap to two lines if the finish value exceeds the maximum column width.

**Important Information and Disclaimer:**The information provided on this page represents TI's knowledge and belief as of the date that it is provided. TI bases its knowledge and belief on information provided by third parties, and makes no representation or warranty as to the accuracy of such information. Efforts are underway to better integrate information from third parties. TI has taken and continues to take reasonable steps to provide representative and accurate information but may not have conducted destructive testing or chemical analysis on incoming materials and chemicals. TI and TI suppliers consider certain information to be proprietary, and thus CAS numbers and other limited information may not be available for release.

In no event shall TI's liability arising out of such information exceed the total purchase price of the TI part(s) at issue in this document sold by TI to Customer on an annual basis.



**TAPE AND REEL INFORMATION**

**QUADRANT ASSIGNMENTS FOR PIN 1 ORIENTATION IN TAPE**

\*All dimensions are nominal

Device	Package Type	Package Drawing	Pins	SPQ	Reel Diameter (mm)	Reel Width W1 (mm)	A0 (mm)	B0 (mm)	K0 (mm)	P1 (mm)	W (mm)	Pin1 Quadrant
CSD22205L	PICOST AR	YMG	4	3000	180.0	8.4	1.26	1.26	0.42	4.0	8.0	Q1
CSD22205LT	PICOST AR	YMG	4	250	180.0	8.4	1.26	1.26	0.42	4.0	8.0	Q1

**TAPE AND REEL BOX DIMENSIONS**

\*All dimensions are nominal

Device	Package Type	Package Drawing	Pins	SPQ	Length (mm)	Width (mm)	Height (mm)
CSD22205L	PICOSTAR	YMG	4	3000	182.0	182.0	20.0
CSD22205LT	PICOSTAR	YMG	4	250	182.0	182.0	20.0

## 重要声明和免责声明

TI“按原样”提供技术和可靠性数据（包括数据表）、设计资源（包括参考设计）、应用或其他设计建议、网络工具、安全信息和其他资源，不保证没有瑕疵且不做任何明示或暗示的担保，包括但不限于对适销性、某特定用途方面的适用性或不侵犯任何第三方知识产权的暗示担保。

这些资源可供使用 TI 产品进行设计的熟练开发人员使用。您将自行承担以下全部责任：(1) 针对您的应用选择合适的 TI 产品，(2) 设计、验证并测试您的应用，(3) 确保您的应用满足相应标准以及任何其他功能安全、信息安全、监管或其他要求。

这些资源如有变更，恕不另行通知。TI 授权您仅可将这些资源用于研发本资源所述的 TI 产品的应用。严禁对这些资源进行其他复制或展示。您无权使用任何其他 TI 知识产权或任何第三方知识产权。您应全额赔偿因在这些资源的使用中对 TI 及其代表造成的任何索赔、损害、成本、损失和债务，TI 对此概不负责。

TI 提供的产品受 [TI 的销售条款](#) 或 [ti.com](#) 上其他适用条款/TI 产品随附的其他适用条款的约束。TI 提供这些资源并不会扩展或以其他方式更改 TI 针对 TI 产品发布的适用的担保或担保免责声明。

TI 反对并拒绝您可能提出的任何其他或不同的条款。

邮寄地址：Texas Instruments, Post Office Box 655303, Dallas, Texas 75265

Copyright © 2022，德州仪器 (TI) 公司