

LM34936 30V 宽输入电压同步 4 开关降压/升压控制器

1 特性

- 单电感降压/升压控制器，用于升压/降压直流/直流转换
- 宽 V_{IN} ：4.2V (2.5V 偏置) 至 30V (42V 最大输入电压)
- 灵活的 V_{OUT} ：0.8 V 至 30 V
- 输出电压短路保护
- 高效降压/升压转换
- 可调开关频率
- 可选频率同步和抖动
- 集成 2A MOSFET 栅极驱动器
- 逐周期电流限制和可选断续模式
- 可选输入或输出平均电流限制
- 可编程输入 UVLO 和软启动
- 电源正常和输出过压保护
- 采用 QFN-28 封装
- 使用 LM34936 并借助 [WEBENCH Power Designer](#) 创建定制设计

2 应用

- 工业 PC 电源
- [USB 电力输送](#)
- 电池供电型系统
- [LED 照明](#)

3 说明

LM34936 是一款同步 4 开关降压/升压直流/直流控制器，能够将输出电压稳定在等于、高于或低于输入电压的某一电压值上。LM34936 在 4.2V 至 30V (最大绝对值为 42V) 的宽输入电压范围内工作，可支持各种不同的应用。

LM34936 在降压和升压工作模式下均采用电流模式控制，以提供出色的负载调节率和线性调节率。开关频率可通过外部电阻进行编程，并且可与外部时钟信号同步。

该器件还具有可编程的软启动功能，并且提供诸如逐周期电流限制、输入欠压闭锁 (UVLO)、输出过压保护 (OVP) 和热关断等各类保护特性。此外，LM34936 具有平均输入或输出电流限制、用于减少峰值 EMI 的展频以及持续过载情况下的断续模式保护等选项。

器件信息

订货编号	封装 ⁽¹⁾	封装尺寸
LM34936RHF	QFN-28	4.0mm x 5.0mm

- (1) 如需了解所有可用封装，请参阅数据表末尾的可订购产品附录。

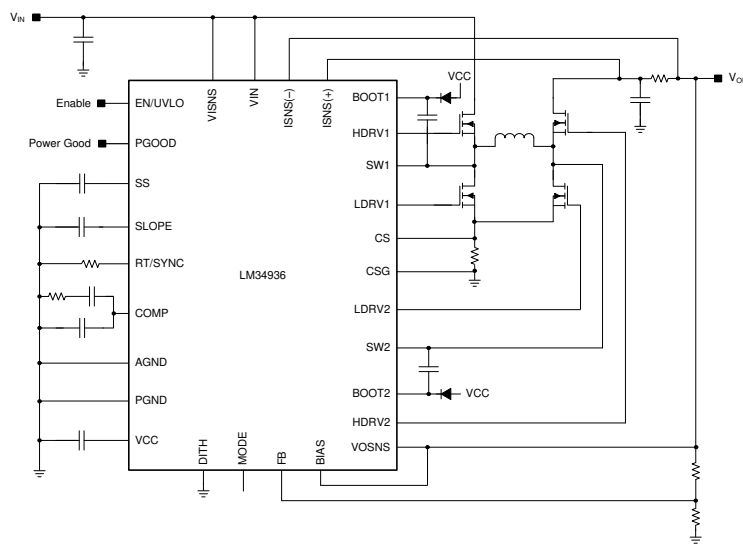

Copyright © 2018, Texas Instruments Incorporated

简化版原理图



Table of Contents

1 特性	1	8 Application and Implementation	21
2 应用	1	8.1 Application Information.....	21
3 说明	1	8.2 Typical Application.....	21
4 Revision History	2	9 Power Supply Recommendations	29
5 Pin Configuration and Functions	3	10 Layout	30
6 Specifications	5	10.1 Layout Guidelines.....	30
6.1 Absolute Maximum Ratings.....	5	10.2 Layout Example.....	31
6.2 ESD Ratings.....	5	11 Device and Documentation Support	32
6.3 Recommended Operating Conditions.....	5	11.1 Device Support.....	32
6.4 Thermal Information.....	6	11.2 Documentation Support.....	32
6.5 Electrical Characteristics.....	6	11.3 接收文档更新通知.....	32
6.6 Typical Characteristics.....	9	11.4 支持资源.....	32
7 Detailed Description	13	11.5 Trademarks.....	32
7.1 Overview.....	13	11.6 Electrostatic Discharge Caution.....	32
7.2 Functional Block Diagram.....	14	11.7 术语表.....	33
7.3 Feature Description.....	14	12 Mechanical, Packaging, and Orderable Information	33
7.4 Device Functional Modes.....	20		

4 Revision History

注：以前版本的页码可能与当前版本的页码不同

Changes from Revision * (September 2018) to Revision A (August 2021)	Page
• 更新了整个文档中的表格、图和交叉参考的编号格式.....	1
• Corrected WEBENCH link.....	22

5 Pin Configuration and Functions



图 5-1. QFN-28 RHF Package Top View

表 5-1. Pin Functions

PIN		DESCRIPTION
NO.	NAME	
1	MODE	1.38 V < MODE < 2.22 V : CCM, Hiccup Enabled (Set R _{MODE} resistor to AGND = 93.1 kΩ). 2.6 V < MODE < VCC: CCM, Hiccup Disabled (Set R _{MODE} resistor to AGND = 200 kΩ or connect to VCC)
2	DITH	A capacitor connected between the DITH pin and AGND is charged and discharged with a current source. As the voltage on the DITH pin ramps up and down the oscillator frequency is modulated by 10% of the nominal frequency set by the RT resistor. Grounding the DITH pin will disable the dithering feature. In the external Sync mode, the DITH pin voltage is ignored.
3	RT/SYNC	Switching frequency programming pin. An external resistor is connected to the RT/SYNC pin and AGND to set the switching frequency. This pin can also be used to synchronize the PWM controller to an external clock.
4	SLOPE	A capacitor connected between the SLOPE pin and AGND provides the slope compensation ramp for stable current mode operation in both buck and boost mode.
5	SS	Soft-start programming pin. A capacitor between the SS pin and AGND pin programs soft-start time.
6	COMP	Output of the error amplifier. An external RC network connected between COMP and AGND compensates the regulator feedback loop.
7	AGND	Analog ground of the IC.
8	FB	Feedback pin for output voltage regulation. Connect a resistor divider network from the output of the converter to the FB pin.
9	VOSNS	V _{OUT} sense input. Connect to the power stage output rail.
10 11	ISNS(-) ISNS(+)	Input or Output Current Sense Amplifier inputs. An optional current sense resistor connected between ISNS(+) and ISNS(-) can be located either on the input side or on the output side of the converter. If the sensed voltage across the ISNS(+) and ISNS(-) pins reaches 50 mV, a slow Constant Current (CC) control loop becomes active and starts discharging the soft-start capacitor to regulate the drop across ISNS(+) and ISNS(-) to 50 mV. Short ISNS(+) and ISNS(-) together to disable this feature.

表 5-1. Pin Functions (continued)

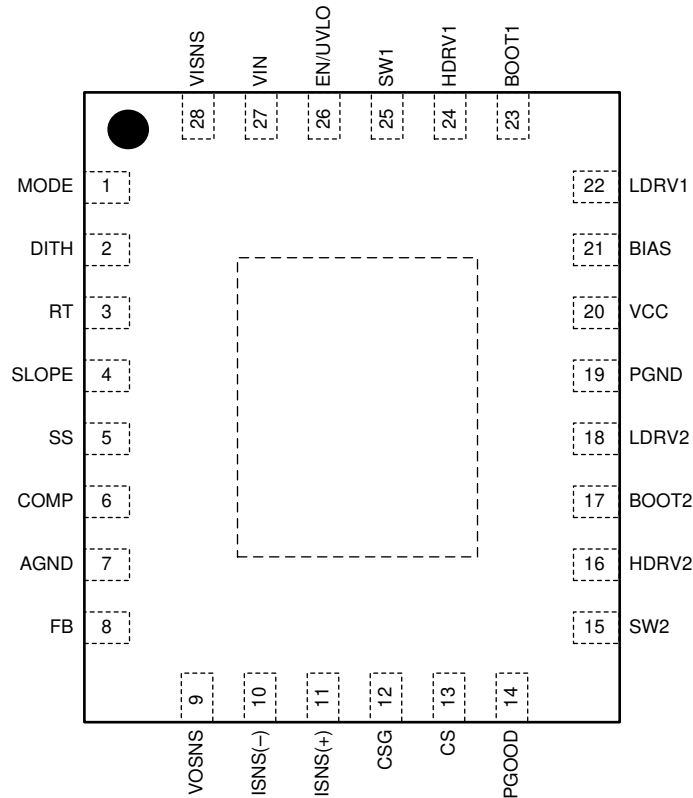
PIN		DESCRIPTION
NO.	NAME	
12	CSG	The negative or ground input to the PWM current sense amplifier. Connect directly to the low-side (ground) of the current sense resistor.
13	CS	The positive input to the PWM current sense amplifier.
14	PGOOD	Power Good open drain output. PGOOD is pulled low when FB is outside a -9%/+10% regulation window around the 0.8-V V_{REF} .
15 25	SW2 SW1	The boost and the buck side switching nodes respectively.
16 24	HDRV2 HDRV1	Output of the high-side gate drivers. Connect directly to the gates of the high-side MOSFETs.
17 23	BOOT2 BOOT1	An external capacitor is required between the BOOT1, BOOT2 pins and the SW1, SW2 pins respectively to provide bias to the high-side MOSFET gate drivers.
18 22	LDRV2 LDRV1	Output of the low-side gate drivers. Connect directly to the gates of the low-side MOSFETs.
19	PGND	Power ground of the IC. The high current ground connection to the low-side gate drivers.
20	VCC	Output of the VCC bias regulator. Connect capacitor to ground.
21	BIAS	Optional input to the VCC bias regulator. Powering VCC from an external supply instead of V_{IN} can reduce power loss at high V_{IN} . For $V_{BIAS} > 8$ V, the VCC regulator draws power from the BIAS pin.
26	EN/UVLO	Enable pin. For $EN/UVLO < 0.4$ V, the LM34936 is in a low current shutdown mode. For $EN/UVLO > 1.22$ V, the PWM function is enabled, provided VCC exceeds the VCC UV threshold.
27	VIN	The input supply pin to the IC. Connect V_{IN} to a supply voltage between 4.2 V and 30 V.
28	VISNS	V_{IN} sense input. Connect to power stage input rail.
-	PowerPAD™	The PowerPAD should be soldered to the analog ground. If possible, use thermal vias to connect to a PCB ground plane for improved power dissipation.

6 Specifications

6.1 Absolute Maximum Ratings

	MIN ⁽¹⁾	MAX	UNIT
VIN, EN/UVLO, VISNS, VOSNS, ISNS(+), ISNS(-)	- 0.3	42	V
BIAS	- 0.3	40	
FB, SS, DITH, RT/SYNC, SLOPE, COMP	- 0.3	3.6	
SW1, SW2	- 1	42	
SW1, SW2 (20 ns transient)	- 5.0	47	
VCC, MODE, PGOOD	- 0.3	8.5	
LDRV1, LDRV2	- 0.3	8.5	
BOOT1, HDRV1 with respect to SW1	- 0.3	8.5	
BOOT2, HDRV2 with respect to SW2	- 0.3	8.5	
ISNS(+) with respect to ISNS(-)	-0.3	0.3	
CS, CSG	- 0.3	0.3	
Operating junction temperature	- 40	125	°C
Storage temperature, T _{stg}	- 65	150	

- (1) Stresses beyond those listed under *Absolute Maximum Ratings* may cause permanent damage to the device. These are stress ratings only, which do not imply functional operation of the device at these or any other conditions beyond those indicated under *Recommended Operating Conditions*. Exposure to absolute-maximum-rated conditions for extended periods may affect device reliability.

6.2 ESD Ratings

		VALUE	UNIT
V _{ESD} ⁽¹⁾	Human body model (HBM) ESD stress voltage ⁽²⁾	±2000	V
	Charged device model (CDM) ESD stress voltage ⁽³⁾	±250	

- (1) Electrostatic discharge (ESD) to measure device sensitivity and immunity to damage caused by assembly line electrostatic discharges into the device.
- (2) Level listed above is the passing level per ANSI/ESDA/JEDEC JS-001. JEDEC document JEP155 states that 500 V HBM allows safe manufacturing with a standard ESD control process.
- (3) Level listed above is the passing level per EIA-JEDEC JESD22-C101. JEDEC document JEP157 states that 250 V CDM allows safe manufacturing with a standard ESD control process. Pins listed as ±250 V may actually have higher performance.

6.3 Recommended Operating Conditions

over operating free-air temperature range (unless otherwise noted)⁽¹⁾

		MIN	NOM	MAX	UNIT
VIN	Input bias voltage	4.2		30	V
VISNS	Input power stage voltage with external bias (BIAS ≥ 5 V or VIN ≥ 4.5 V)	2.5		30	
BIAS	Bias supply voltage range (when VCC in regulation)	8		30	
VOSNS	Output voltage range	0.8		30	
EN/UVLO	Enable voltage range	0		30	
ISNS(+), ISNS(-)	Average current sense common mode range	0		30	
T _J	Operating temperature range ⁽²⁾	- 40		125	°C
F _{sw}	Operating frequency range	100		600	kHz

- (1) *Recommended Operating Conditions* are conditions under the device is intended to be functional. For specifications and test conditions, see ¶ 6.5.
- (2) High junction temperatures degrade operating lifetimes. Operating lifetime is de-rated for junction temperatures greater than 125°C.

6.4 Thermal Information

THERMAL METRIC ⁽¹⁾		LM34936	UNIT
		RHF (QFN)	
		28 PINS	
$R_{\theta JA}$	Junction-to-ambient thermal resistance	34.7	°C/W
$R_{\theta JC(top)}$	Junction-to-case (top) thermal resistance	26.6	
$R_{\theta JB}$	Junction-to-board thermal resistance	6.3	
ψ_{JT}	Junction-to-top characterization parameter	0.3	
ψ_{JB}	Junction-to-board characterization parameter	6.2	
$R_{\theta JC(bot)}$	Junction-to-case (bottom) thermal resistance	2.0	

(1) For more information about traditional and new thermal metrics, see the [Semiconductor and IC Package Thermal Metrics](#) application report.

6.5 Electrical Characteristics

Typical values correspond to $T_J = 25^\circ\text{C}$. Minimum and maximum limits apply over the -40°C to 125°C junction temperature range unless otherwise stated. $V_{IN} = 24\text{ V}$ unless otherwise stated.⁽¹⁾

PARAMETER		TEST CONDITION	MIN	TYP	MAX	UNIT
SUPPLY VOLTAGE (V_{IN})						
I_Q	V_{IN} shutdown current	$V_{EN/UVLO} = 0\text{ V}$		2.6	10	μA
	V_{IN} operating current	$V_{EN/UVLO} = 2\text{ V}, V_{FB} = 0.9\text{ V}$		2	4	mA
VCC						
$V_{VCC(VIN)}$	Regulation voltage	$V_{BIAS} = 0\text{ V}, \text{VCC open}$	6.95	7.35	7.88	V
$V_{UV(VCC)}$	VCC Undervoltage lockout	VCC increasing	3.11	3.27	3.43	
	Undervoltage hysteresis			176		mV
I_{VCC}	VCC current limit	$V_{VCC} = 0\text{ V}$	65			mA
$R_{OUT(VCC)}$	VCC regulator output impedance	$I_{VCC} = 30\text{ mA}, V_{IN} = 4\text{ V}$		8	16	Ω
BIAS						
$V_{BIAS(SW)}$	BIAS switchover voltage	$V_{IN} = 24\text{ V}$	7.25	8	8.75	V
EN/UVLO						
$V_{EN(STBY)}$	Standby threshold	EN/UVLO rising	0.55	0.82	0.97	V
$I_{EN(STBY)}$	Standby source current	$V_{EN/UVLO} = 1.1\text{ V}$	1	2	3	μA
$V_{EN(OP)}$	Operating threshold	EN/UVLO rising	1.17	1.22	1.29	V
$\Delta I_{HYS(OP)}$	Operating hysteresis current	$V_{EN/UVLO} = 1.5\text{ V}$	2.15	3.15	4.25	μA
SS						
I_{SS}	Soft-start pull up current	$V_{SS} = 0\text{ V}$	3.75	5	6.35	μA
$V_{SS(CL)}$	SS clamp voltage	SS open		1.21		V
$V_{FB} - V_{SS}$	FB to SS offset	$V_{SS} = 0\text{ V}$		-18		mV
EA (ERROR AMPLIFIER)						
V_{REF}	Feedback reference voltage	FB = COMP	0.788	0.800	0.812	V
g_{mEA}	Error amplifier gm			1.31		mS
I_{SINK}/I_{SOURCE}	COMP sink/source current	$V_{FB} = V_{REF} \pm 300\text{ mV}$		280		μA
R_{OUT}	Amplifier output resistance			20		$\text{M}\Omega$
BW	Unity gain bandwidth			2		MHz
$I_{BIAS(FB)}$	Feedback pin input bias current	FB in regulation			25	nA
FREQUENCY						
$f_{SW(1)}$	Switching Frequency 1	RT = 40 $\text{k}\Omega$	175	200	225	kHz
$f_{SW(2)}$	Switching Frequency 2	RT = 20 $\text{k}\Omega$	350	390	430	

Typical values correspond to $T_J = 25^\circ\text{C}$. Minimum and maximum limits apply over the -40°C to 125°C junction temperature range unless otherwise stated. $V_{IN} = 24\text{ V}$ unless otherwise stated.⁽¹⁾

PARAMETER		TEST CONDITION	MIN	TYP	MAX	UNIT
DITHER						
I_{DITHER}	Dither source/sink current			11		μA
V_{DITHER}	Dither high threshold			1.27		V
	Dither low threshold			1.16		
SYNC						
V_{SYNC}	Sync input high threshold		2.1			V
	Sync input low threshold				1.2	
PW_{SYNC}	Minimum sync input pulse width		50			ns
CURRENT LIMIT						
$V_{CS(BUCK)}$	Buck current limit threshold (Valley)	$V_{IN} = V_{VISNS} = 24\text{ V}$, $V_{VOSNS} = 12\text{ V}$, $V_{SLOPE} = 0\text{ V}$	60	80	94	mV
$V_{CS(BOOST)}$	Boost current limit threshold (Peak)	$V_{IN} = V_{VISNS} = 12\text{ V}$, $V_{VOSNS} = 18\text{ V}$, $V_{SLOPE} = 0\text{ V}$	96	120	140	
$I_{BIAS(CS/CSG)}$	CS/CSG pin bias current	$V_{CS} = V_{CSG} = 0\text{ V}$		-80		μA
$I_{OFFSET(CS/CSG)}$	CSG pin bias current	$V_{CS} = V_{CSG} = 0\text{ V}$			19	
CONSTANT CURRENT LOOP						
V_{SNS}	Average current loop regulation target	$V_{ISNS(-)} = 24\text{ V}$, sweep $ISNS(+)$, $V_{SS} = 0.8\text{ V}$	43	50	57	mV
I_{SNS}	$ISNS(+)$ / $ISNS(-)$ pin bias currents	$V_{ISNS(+)} = V_{ISNS(-)} = V_{IN} = 24\text{ V}$		3		μA
Gm	gm of soft-start pull down amplifier	$V_{ISNS(+)} - V_{ISNS(-)} = 55\text{ mV}$, $V_{SS} = 0.5\text{ V}$		1		mS
SLOPE						
I_{SLOPE}	Buck adaptive slope current	$V_{IN} = V_{VISNS} = 24\text{ V}$, $V_{VOSNS} = 12\text{ V}$, $V_{SLOPE} = 0\text{ V}$	24	30	35	μA
	Boost adaptive slope current	$V_{IN} = V_{VISNS} = 12\text{ V}$, $V_{VOSNS} = 18\text{ V}$, $V_{SLOPE} = 0\text{ V}$	13	17	21	
gm_{SLOPE}	Slope compensation amplifier gm			2		μS
MODE						
I_{MODE}	Source current out of MODE pin		17	20	23	μA
V_{CCM_HIC}	CCM with hiccup threshold		1.18	1.28	1.38	V
V_{CCM}	CCM no hiccup threshold		2.22	2.4	2.6	V

LM34936

ZHCSIQ5A - SEPTEMBER 2018 - REVISED AUGUST 2021

Typical values correspond to $T_J = 25^\circ\text{C}$. Minimum and maximum limits apply over the -40°C to 125°C junction temperature range unless otherwise stated. $V_{IN} = 24\text{ V}$ unless otherwise stated.⁽¹⁾

PARAMETER		TEST CONDITION	MIN	TYP	MAX	UNIT
PGOOD						
V_{PGD}	PGOOD trip threshold for falling FB	Measured with respect to V_{REF}		- 9		%
	PGOOD trip threshold for rising FB	Measured with respect to V_{REF}		10		%
	Hysteresis			2.5		%
$I_{LEAK(PGD)}$	PGOOD leakage current				100	nA
$I_{SINK(PGD)}$	PGOOD sink current	$V_{PGOOD} = 0.4\text{ V}$	2	4.2	6.5	mA
OUTPUT OVP						
V_{OVP}	Output overvoltage threshold at FB pin	Measured with respect to V_{REF}		10		%
	Hysteresis			2.5		%
NMOS DRIVERS						
$I_{HDRV1,2}$	Driver peak source current	$V_{BOOT} - V_{SW} = 7\text{ V}$		1.8		A
	Driver peak sink current	$V_{BOOT} - V_{SW} = 7\text{ V}$		2.2		
$I_{LDRV1,2}$	Driver peak source current			1.8		
	Driver peak sink current			2.2		
$R_{HDRV1,2}$	Driver pull up resistance	$V_{BOOT} - V_{SW} = 7\text{ V}$		1.8		Ω
	Driver pull down resistance	$V_{BOOT} - V_{SW} = 7\text{ V}$		1.1		
$V_{UV(BOOT1,2)}$	BOOT1,2 to SW1,2 UVLO threshold	HDRV1,2 shut off		3.4		V
	BOOT1,2 to SW1,2 UVLO hysteresis	HDRV1,2 start switching		150		mV
$R_{LDRV1,2}$	Driver pull up resistance			1.7		Ω
	Driver pull down resistance			1.3		
t_{DT1}	Dead time HDRV1,2 off to LDRV1,2 on			45		ns
t_{DT2}	Dead time LDRV1,2 off to HDRV1,2 on			45		
THERMAL SHUTDOWN						
T_{SD}	Thermal shutdown temperature			165		$^\circ\text{C}$
$T_{SD(HYS)}$	Thermal shutdown hysteresis			15		

- (1) All minimum and maximum limits are specified by correlating the electrical characteristics to process and temperature variations and applying statistical process control.

6.6 Typical Characteristics

At $T_A = 25^\circ\text{C}$, unless otherwise stated.

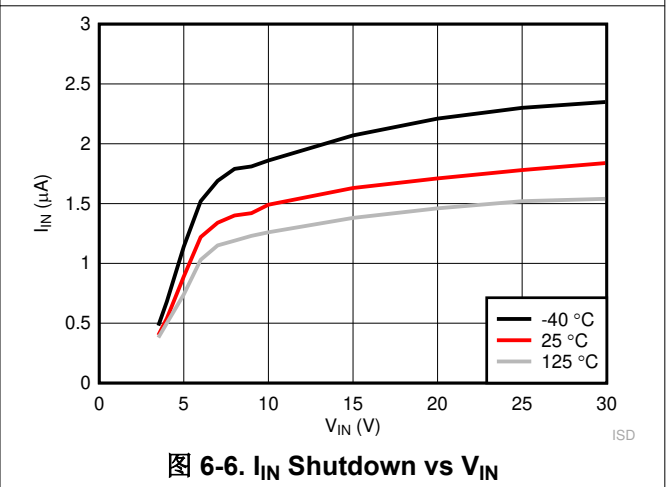
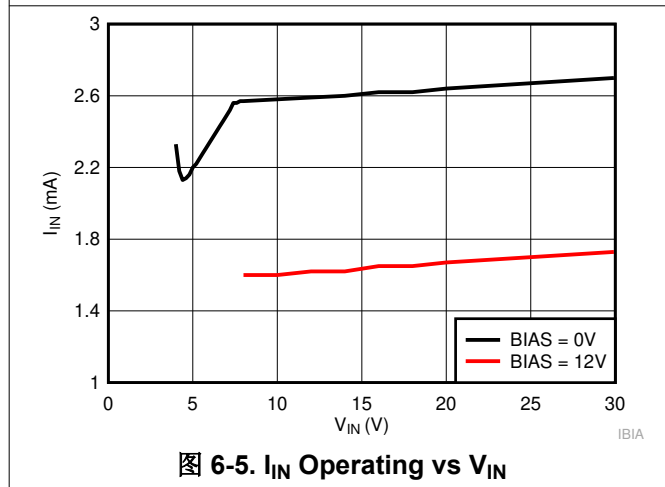
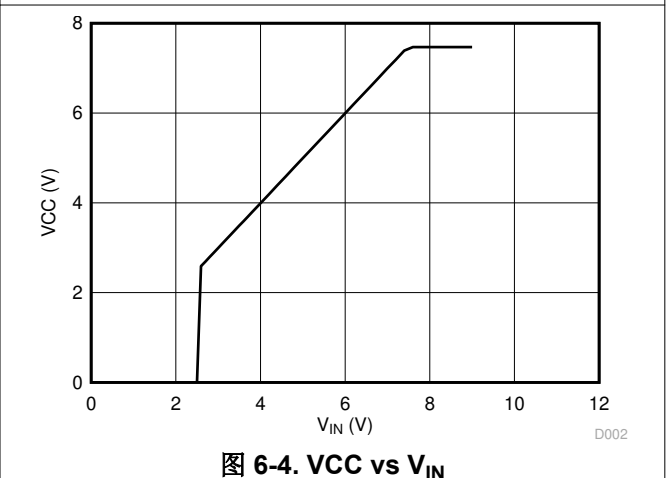
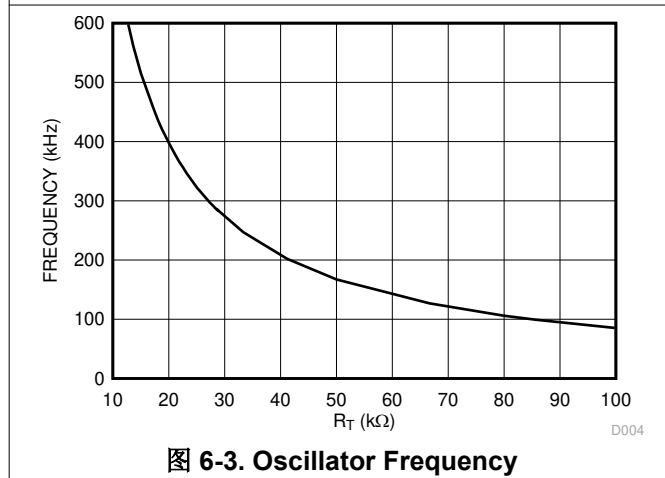
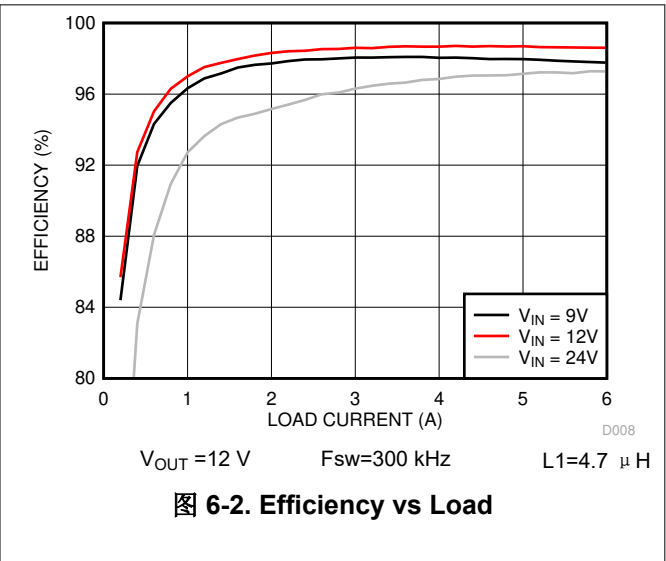
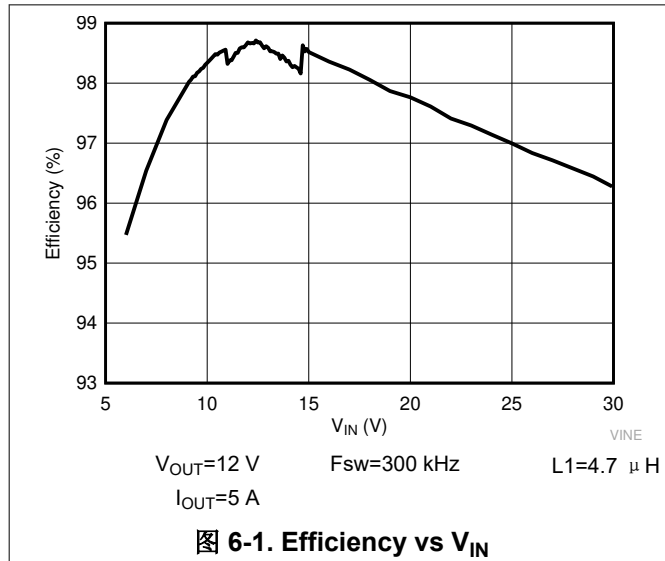



图 6-7. ENABLE/UVLO Rising Threshold vs Temperature



图 6-8. Buck Current Limit vs Temperature

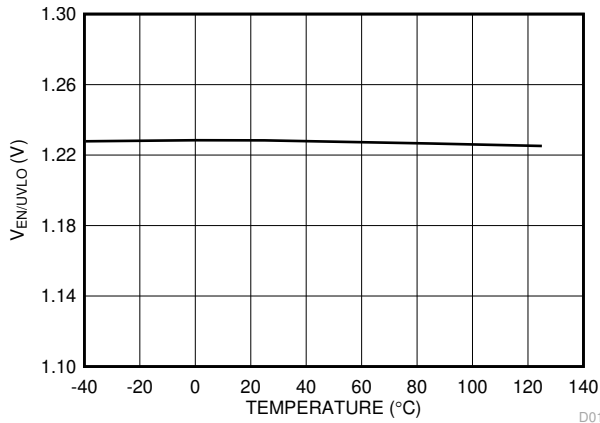

图 6-9. Boost Current Limit vs Temperature

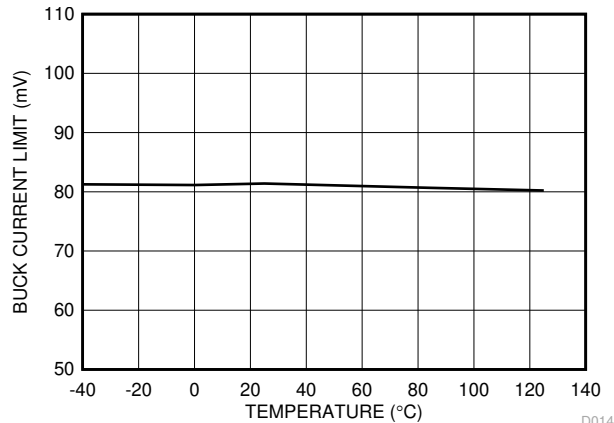

图 6-10. Forced CCM Operation (Boost)

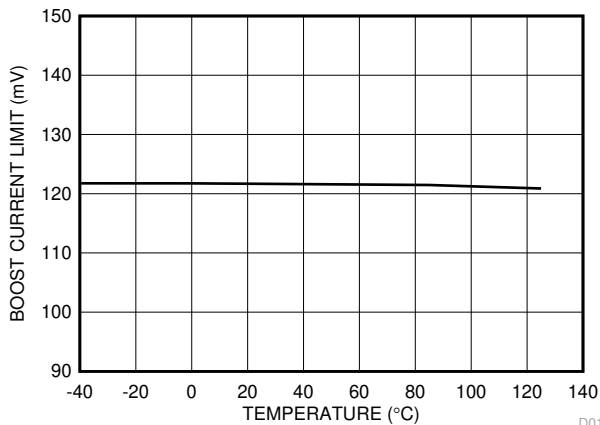

图 6-11. Forced CCM Operation (Buck-Boost)

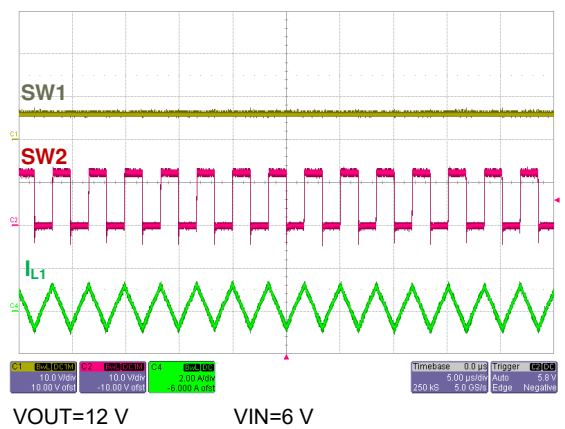

图 6-12. Forced CCM Operation (Buck-Boost)

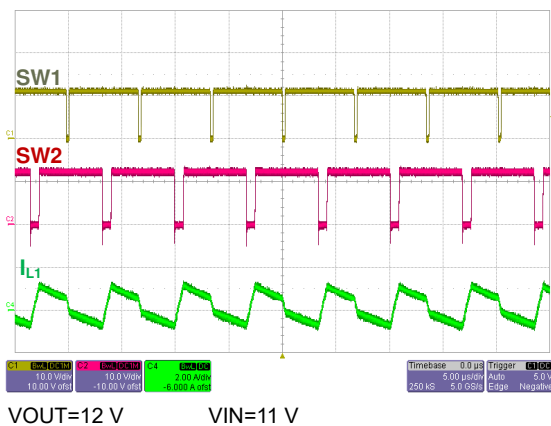

图 6-13. Forced CCM Operation (Buck-Boost)

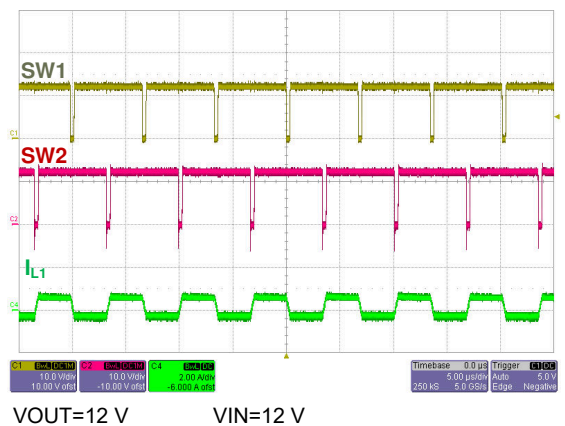

图 6-14. Forced CCM Operation (Buck)

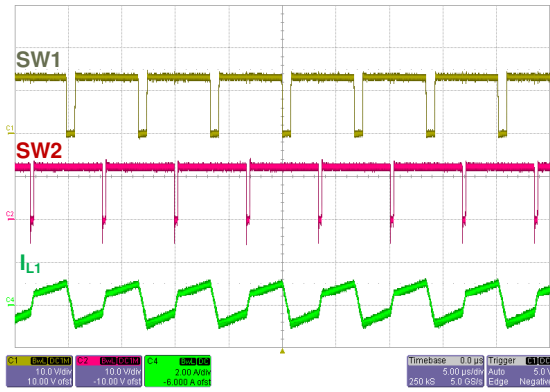

图 6-15. Load Step (Boost)

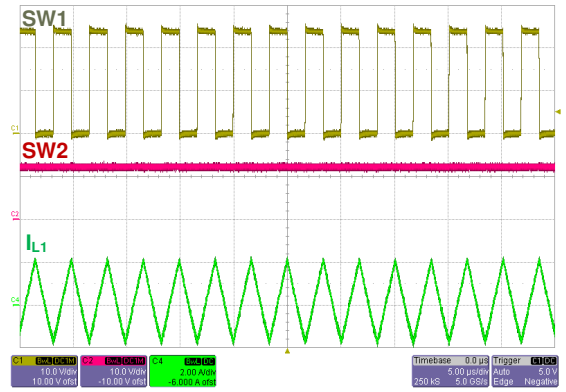

图 6-16. Load Step (Buck-Boost)

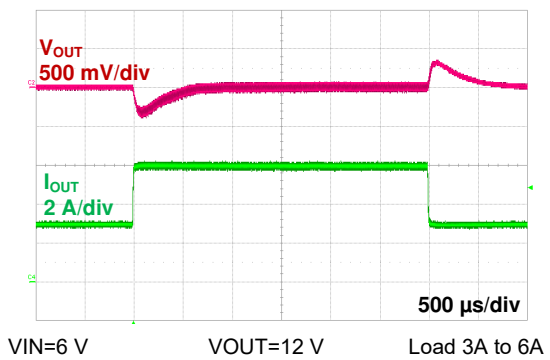

图 6-17. Load Step (Buck)

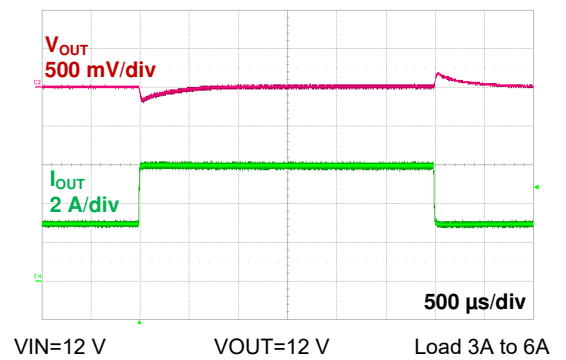

图 6-18. Line Transient

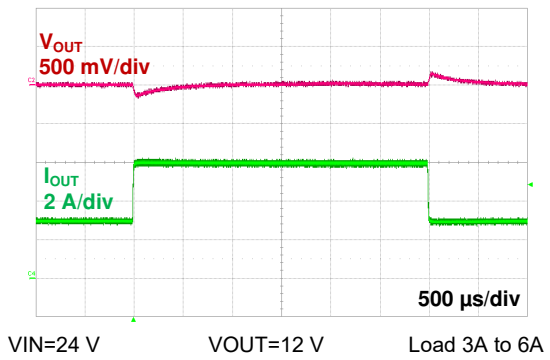

图 6-19. Hiccup Mode Current Limit

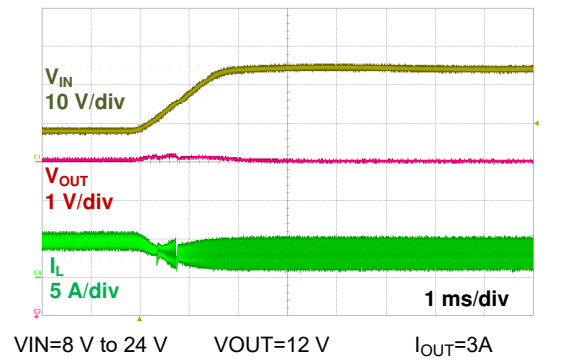

图 6-20. Constant Current Constant Voltage (CCCV) Operation

7 Detailed Description

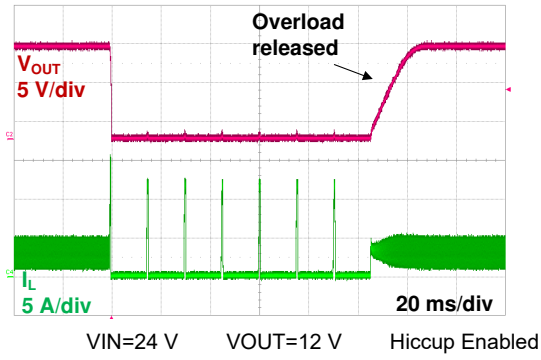
7.1 Overview

The LM34936 is a wide input voltage four-switch buck-boost controller IC with integrated drivers for N-channel MOSFETs. It operates in the buck mode when V_{IN} is greater than V_{OUT} and in the boost mode when V_{IN} is less than V_{OUT} . When V_{IN} is close to V_{OUT} , the device operates in a proprietary transition buck or boost mode. The control scheme provides smooth operation for any input/output combination within the specified operating range. The buck or boost transition control scheme provides a low ripple output voltage when V_{IN} equals V_{OUT} without compromising the efficiency.

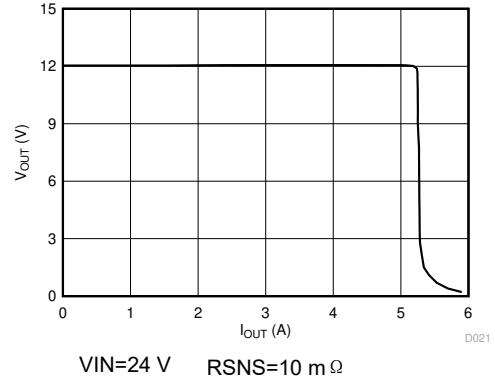
The LM34936 integrates four N-Channel MOSFET drivers including two low-side drivers and two high-side drivers, eliminating the need for external drivers or floating bias supplies. The internal VCC regulator supplies internal bias rails as well as the MOSFET gate drivers. The VCC regulator is powered either from the input voltage through the VIN pin or from the output or an external supply through the BIAS pin for improved efficiency.

The PWM control scheme is based on valley current mode control for buck operation and peak current mode control for boost operation. The inductor current is sensed through a single sense resistor in series with the low-side MOSFETs. The sensed current is also monitored for cycle-by-cycle current limit. The behavior of the LM34936 during an overload condition is dependent on the MODE pin programming (see [# 7.4.2](#)). If hiccup mode fault protection is selected, the controller turns off after a fixed number of switching cycles in cycle-by-cycle current limit and restarts after another fixed number of clock cycles. The hiccup mode reduces the heating in the power components in a sustained overload condition. If hiccup mode is disabled through the MODE pin, the controller remains in a cycle-by-cycle current limit condition until the overload is removed.

In addition to the cycle-by-cycle current limiting, the LM34936 also provides an optional average current regulation loop that can be configured for either input or output current limiting. This is useful for battery charging or other applications where a constant current behavior may be required.

The soft-start time of LM34936 is programmed by a capacitor connected to the SS pin to minimize the inrush current and overshoot during startup.

The precision EN/UVLO pin supports programmable input undervoltage lockout (UVLO) with hysteresis. The output overvoltage protection (OVP) feature turns off the high-side drivers when the voltage at the FB pin exceeds the output overvoltage threshold (V_{OVP}). The PGOOD output indicates when the FB voltage is inside the PGOOD regulation window centered at V_{REF} .

7.2 Functional Block Diagram

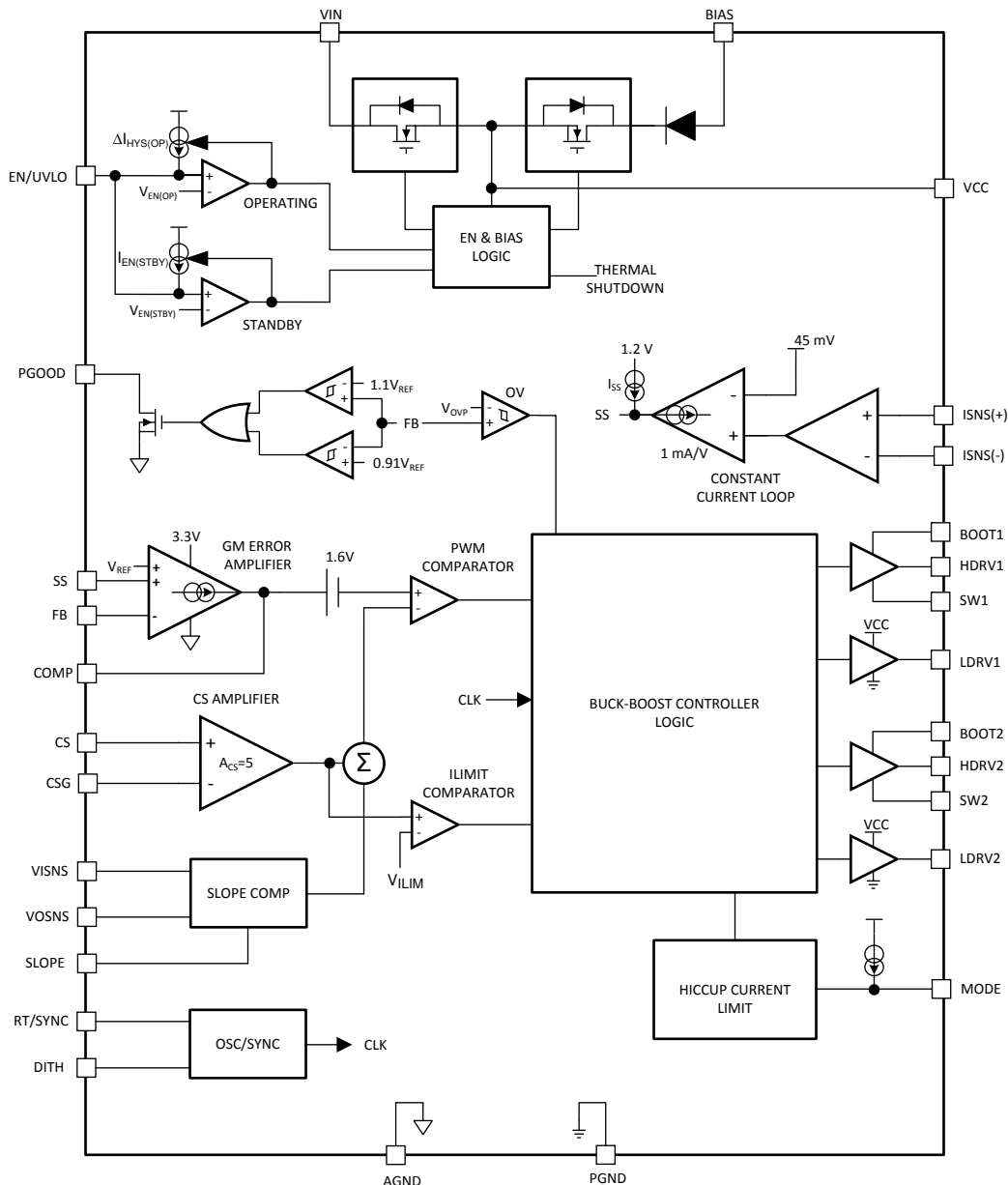

7.3 Feature Description

7.3.1 Fixed Frequency Valley/Peak Current Mode Control with Slope Compensation

The LM34936 implements a fixed frequency current mode control of both the buck and boost switches. The output voltage, scaled down by the feedback resistor divider, appears at the FB pin and is compared to the internal reference (V_{REF}) by an internal error amplifier. The error amplifier produces an error voltage by driving the COMP pin. An adaptive slope compensation signal based on V_{IN} , V_{OUT} , and the capacitor at the SLOPE pin is added to the current sense signal measured across the CS and CSG pins. The result is compared to the COMP error voltage by the PWM comparator.

The LM34936 regulates the output using valley current mode control in buck mode and peak current mode control in boost mode. For valley current mode control, the high-side buck MOSFET controlled by HDRV1 is turned on by the PWM comparator at the valley of the inductor ripple current and turned off by the oscillator clock signal. Valley current mode control is advantageous for buck converters where the PWM controller must resolve very short on-times. For peak current mode control in the boost mode, the low-side boost MOSFET controlled by

LDRV2 is turned on by the clock signal in each switching cycle and turned off by the PWM comparator at the peak of the inductor ripple current.

The low-side gate drive LDRV1, complementary to the HDRV1 drive signal, controls the synchronous rectification MOSFET of the buck stage. The high-side gate drive HDRV2, complementary to the low-side gate drive LDRV2, controls the high-side synchronous rectifier of the boost stage. For operation with V_{IN} close to V_{OUT} , the LM34936 uses a proprietary buck or boost transition scheme to achieve smooth, low ripple transition zone behavior.

Peak and valley current mode controllers require slope compensation for stable current loop operation at duty cycle greater than 50% in peak current mode control and less than 50% in valley current mode control. The LM34936 provides a SLOPE pin to program optimum slope for any V_{IN} and V_{OUT} combination using an external capacitor.

7.3.2 VCC Regulator and Optional BIAS Input

The VCC regulator provides a regulated bias supply to the gate drivers. When EN/UVLO is above the standby threshold ($V_{EN(STBY)}$), the VCC regulator is turned on. For V_{IN} less than the VCC regulation target, the VCC voltage tracks V_{IN} with a small voltage drop as shown in 图 6-4. If the EN/UVLO input is above the operating threshold ($V_{EN(OP)}$) and VCC exceeds the VCC UV threshold ($V_{UV(VCC)}$), the controller is enabled and switching begins.

The VCC regulator draws power from V_{IN} when there is no supply voltage connected to the BIAS pin. If the BIAS pin is connected to an external voltage source that exceeds VCC by one diode drop, the VCC regulator draws power from the BIAS input instead of V_{IN} . Connecting the BIAS pin to V_{OUT} in applications with V_{OUT} greater than 8.5 V improves the efficiency of the regulator in the buck mode.

For low V_{IN} operation, ensure that the VCC voltage is sufficient to fully enhance the MOSFETs. Use an external bias supply if V_{IN} dips below the voltage required to sustain the VCC voltage. For these conditions, use a series blocking diode between the input supply and the VIN pin (图 7-1). This prevents VCC from back-feeding into V_{IN} through the body diode of the VCC regulator.

A ceramic capacitor of 16 V or higher voltage rating and a value between 1 μ F and 4.7 μ F is required to supply the VCC regulator load transients. The VCC bypass capacitor should be connected between VCC and PGND pins.

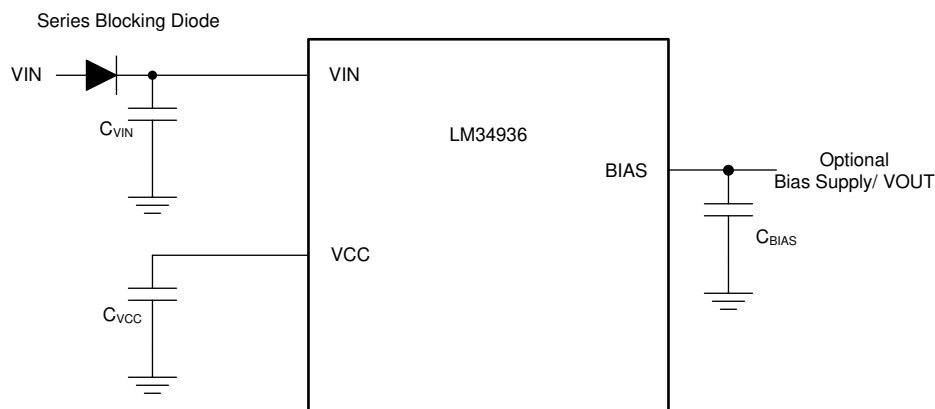

Copyright © 2018, Texas Instruments Incorporated

图 7-1. VCC Regulator and Optional BIAS

7.3.3 Enable/UVLO

The LM34936 has a dual function enable and undervoltage lockout (UVLO) circuit. The EN/UVLO pin has three distinct voltage ranges: shutdown, standby, and operating (see 节 7.4.1). When the EN/UVLO pin is below the standby threshold $V_{EN(STBY)}$, the converter is held in a low power shutdown mode. When EN/UVLO voltage is greater than the standby threshold $V_{EN(STBY)}$ but less than the operating threshold $V_{EN(OP)}$, the internal bias rails and the VCC regulator are enabled but the soft-start (SS) pin is held low and the PWM controller is disabled. A

pull-up current $I_{EN(STBY)}$ is sourced out of the EN/UVLO pin in standby mode to provide hysteresis between the shutdown mode and the standby mode. When EN/UVLO is greater than the operating threshold $V_{EN(OP)}$ and VCC is above the undervoltage threshold $V_{UV(VCC)}$, the controller starts operation. A hysteresis current $\Delta I_{HYS(OP)}$ is sourced out of the EN/UVLO pin when the EN/UVLO input exceeds the operating threshold to provide hysteresis that prevents on/off chattering in the presence of noise with a slowly changing input voltage.

The V_{IN} UVLO threshold is typically set by a resistor divider from V_{IN} to AGND (图 7-2). The turn-on threshold $V_{IN(UV)}$ is calculated using 方程式 1 where R_{UV2} is the upper resistor and R_{UV1} is the lower resistor in the EN/UVLO resistor divider:

$$V_{IN(UV)} = V_{EN(OP)} \times \left(1 + \frac{R_{UV2}}{R_{UV1}} \right) - R_{UV2} \times I_{EN(STBY)} \quad (1)$$

The hysteresis between the UVLO turn-on threshold and turn-off threshold is set by the upper resistor in the EN/UVLO resistor divider and is given by:

$$\Delta V_{HYS(UV)} = \Delta I_{HYS(OP)} \times R_{UV2} \quad (2)$$

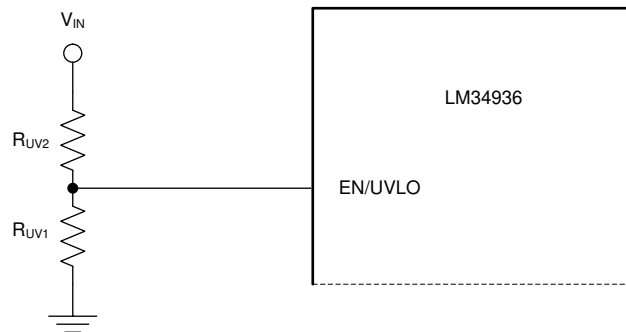

Copyright © 2018, Texas Instruments Incorporated

图 7-2. UVLO Threshold Programming

7.3.4 Soft-Start

The LM34936 soft-start time is programmed using a soft-start capacitor from the SS pin to AGND. When the converter is enabled, an internal current source (I_{SS}) charges the soft-start capacitor. When the SS pin voltage is below the feedback reference voltage V_{REF} , the soft-start pin controls the regulated FB voltage. Once SS exceeds V_{REF} , the soft-start interval is complete and the error amplifier is referenced to V_{REF} . The soft-start time is given by 方程式 3:

$$t_{SS} = \frac{C_{SS} \times V_{REF}}{I_{SS}} \quad (3)$$

The soft-start capacitor is internally discharged when the converter is disabled because of EN/UVLO falling below the operating threshold or VCC falling below the VCC UV threshold. The soft-start pin is also discharged when the converter is in hiccup mode current limiting or in thermal shutdown. When average input or output current limiting is active, the soft-start capacitor is discharged by the constant current loop transconductance (gm) amplifier to limit either input or output current.

7.3.5 Overcurrent Protection

The LM34936 provides cycle-by-cycle current limit to protect against overcurrent and short circuit conditions. In buck operation, the sensed valley voltage across the CSG and CS pins is limited to $V_{CS(BUCK)}$. The high-side buck switch skips a cycle if the sensed voltage does not fall below this threshold during the buck switch off time. In boost operation, the maximum peak voltage across CS and CSG is limited to $V_{CS(BOOST)}$. If the peak current in

the low-side boost switch causes the voltage across CS and CSG to exceed this threshold voltage, the boost switch is turned off for the remainder of the clock cycle.

Applying the appropriate voltage to the MODE pin of the LM34936 enables hiccup mode fault protection (see [节 7.4.2](#)). In the hiccup mode, the controller shuts down after detecting cycle-by-cycle current limiting for 128 consecutive cycles and the soft-start capacitor is discharged. The soft-start capacitor is automatically released after 4000 oscillator clock cycles and the controller restarts. If hiccup mode protection is not enabled through the MODE pin, the LM34936 will operate in cycle-by-cycle current limiting as long as the overload condition persists.

7.3.6 Average Input/Output Current Limiting

The LM34936 provides optional average current limiting capability to limit either the input or the output current of the DC/DC converter. The average current limiting circuit uses an additional current sense resistor connected in series with the input supply or output voltage of the converter. A current sense gm amplifier with inputs at the ISNS(+) and ISNS(-) pins monitors the voltage across the sense resistor and compares it with an internal 50 mV reference. If the drop across the sense resistor is greater than 50 mV, the gm amplifier gradually discharges the soft-start capacitor. When the soft-start capacitor discharges below the feedback reference voltage V_{REF} , the output voltage of the converter decreases to limit the input or output current. The average current limiting feature can be used in applications requiring a regulated current from the input supply or into the load. The target constant current is given by [方程式 4](#):

$$I_{CL(AVG)} = \frac{50 \text{ mV}}{R_{SNS}} \quad (4)$$

A filter network as shown in [图 8-1](#) is often used across ISNS(+) and ISNS(-) pins to filter the ripple in the average current sense signal.

The average current loop can be disabled by shorting the ISNS(+) and ISNS(-) pins together to AGND.

7.3.7 Operation Above 28-V Input

For application where input voltage is higher than 28 V, a 2 k Ω resistor in series with the VISNS pin is required as shown in [图 8-1](#).

7.3.8 CCM Operation

The LM34936 works in continuous conduction mode (CCM). In CCM operation the inductor current can flow in either direction and the controller switches at a fixed frequency regardless of the load current. The CCM operation is useful for noise-sensitive applications where a fixed switching eases filter design.

7.3.9 Frequency and Synchronization (RT/SYNC)

The LM34936 switching frequency can be programmed between 100 kHz and 600 kHz using a resistor from the RT/SYNC pin to AGND. The R_T resistor is related to the nominal switching frequency (F_{sw}) by the [方程式 5](#):

$$R_T = \frac{\left(\frac{1}{F_{sw}}\right) - 190 \text{ ns}}{116 \text{ pF}} \quad (5)$$

[图 6-3](#) in the [节 6.6](#) shows the relationship between the programmed switching frequency (F_{sw}) and the R_T resistor.

The RT/SYNC pin can also be used for synchronizing the internal oscillator to an external clock signal. The external synchronization pulse is ac coupled using a capacitor to the RT/SYNC pin. The external synchronization pulse frequency range is 75% to 125% of the resistor programmed frequency. A 50% duty cycle is acceptable for external SYNC.

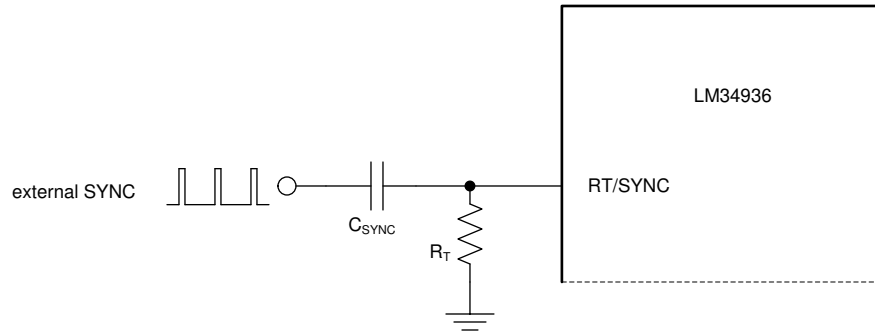

Copyright © 2018, Texas Instruments Incorporated

图 7-3. Using External SYNC

7.3.10 Frequency Dithering

The LM34936 provides an optional frequency dithering function that is enabled by connecting a capacitor from DITH to AGND. 图 7-4 illustrates the dithering circuit. A triangular waveform centered at 1.22 V is generated across the C_{DITH} capacitor. This triangular waveform modulates the oscillator frequency by 10% of the nominal frequency set by the R_T resistor. The C_{DITH} capacitance value sets the rate of the low frequency modulation. A lower C_{DITH} capacitance will modulate the oscillator frequency at a faster rate than a higher capacitance. For the dithering circuit to effectively reduce peak EMI, the modulation rate must be much less than the oscillator frequency (F_{sw}). 方程式 6 calculates the DITH pin capacitance required to set the modulation frequency, F_{MOD} . Connecting the DITH pin directly to AGND disables frequency dithering, and the internal oscillator operates at a fixed frequency set by the R_T resistor. Dither is disabled when external SYNC is used.

$$C_{DITH} = \frac{10 \mu A}{F_{MOD} \times 0.24 V} \quad (6)$$

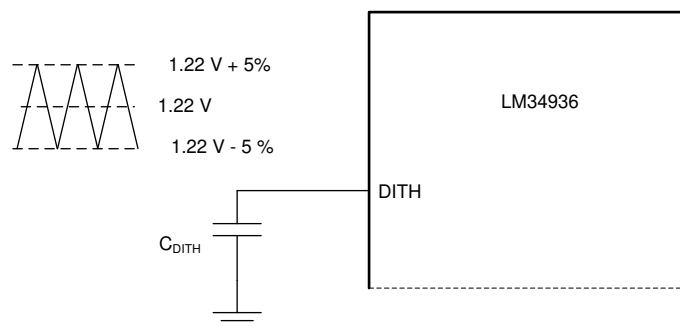

Copyright © 2018, Texas Instruments Incorporated

图 7-4. Dither Operation

7.3.11 Output Overvoltage Protection (OVP)

The LM34936 provides an output overvoltage protection (OVP) circuit that turns off the gate drives when the feedback voltage is above the output overvoltage threshold V_{OVP} . Switching resumes once the feedback voltage falls below the OVP threshold. There is a small hysteresis to prevent chattering.

7.3.12 Power Good (PGOOD)

PGOOD is an open drain output that is pulled low when the voltage at the FB pin is outside -9% / +10% of the nominal V_{REF} . The PGOOD internal N-Channel MOSFET pull-down strength is typically 4.2 mA. This pin can be connected to a voltage supply of up to 8 V through a pull-up resistor.

7.3.13 Gm Error Amplifier

The LM34936 has a gm error amplifier for loop compensation. The gm amplifier output (COMP) range is 0.3 V to 3 V. Connect an R_{C1} - C_{C1} compensation network between COMP and ground for type II (PI) compensation (see [图 8-1](#)). Another pole is usually added using C_{C2} to suppress higher frequency noise and switching frequency ripple.

The COMP output voltage (V_{COMP}) range limits the possible V_{IN} and I_{OUT} range for a given design. In buck mode, the maximum V_{IN} for which the converter can regulate the output at no load is when V_{COMP} reaches 0.3 V. [方程式 7](#) gives V_{COMP} as a function of V_{IN} at no load in CCM buck mode:

$$V_{COMP(BUCK)} = 1.6 \text{ V} - A_{CS} \cdot R_{SENSE} \cdot \frac{V_{OUT}}{2 \cdot L1 \cdot F_{sw}} \cdot (1 - D_{BUCK}) - \frac{2 \mu\text{S} \cdot (V_{IN} - V_{OUT}) + 6 \mu\text{A}}{C_{SLOPE} \cdot F_{sw}} \cdot (1 - D_{BUCK}) \quad (7)$$

Where D_{BUCK} in the equation [方程式 7](#) is the buck duty cycle given by:

$$D_{BUCK} = \frac{V_{OUT}}{V_{IN}} \quad (8)$$

A larger $L1$, lower slope ripple (higher C_{SLOPE}), smaller sense resistor (R_{SENSE}), and higher frequency can increase the maximum V_{IN} range for buck operation.

For boost mode, the minimum V_{IN} for which the converter can regulate the output at full load is when V_{COMP} reaches 3 V. [方程式 9](#) gives V_{COMP} as a function of V_{IN} in boost mode:

$$V_{COMP(BOOST)} = 1.6 \text{ V} + A_{CS} \cdot R_{SENSE} \cdot \left(I_{OUT} \cdot \frac{V_{OUT}}{V_{IN}} + \frac{V_{IN}}{2 \cdot L1 \cdot F_{sw}} \cdot D_{BOOST} \right) + \frac{2 \mu\text{S} \cdot (V_{OUT} - V_{IN}) + 5 \mu\text{A}}{C_{SLOPE} \cdot F_{sw}} \cdot D_{BOOST} \quad (9)$$

Where D_{BOOST} in the [方程式 9](#) is the boost duty cycle given by:

$$D_{BOOST} = 1 - \frac{V_{IN}}{V_{OUT}} \quad (10)$$

A larger $L1$, lower slope ripple (higher C_{SLOPE}), smaller sense resistor (R_{SENSE}), and higher frequency can extend the minimum V_{IN} range for boost operation.

7.3.14 Integrated Gate Drivers

The LM34936 provides four N-channel MOSFET gate drivers: two floating high-side gate drivers at the HDRV1 and HDRV2 pins, and two ground referenced low-side drivers at the LDRV1 and LDRV2 pins. Each driver is capable of sourcing 1.8 A and sinking 2.2 A peak current. In buck operation, LDRV1 and HDRV1 are switched by the PWM controller while HDRV2 remains continuously on. In boost operation, LDRV2 and HDRV2 are switched while HDRV1 remains continuously on.

The low-side gate drivers are powered from VCC and the high-side gate drivers HDRV1 and HDRV2 are powered from bootstrap capacitors C_{BOOT1} (between BOOT1 and SW1) and C_{BOOT2} (between BOOT2 and SW2) respectively. The C_{BOOT1} and C_{BOOT2} capacitors are charged through external Schottky diodes connected to the VCC pin as shown in [图 8-1](#).

In most applications, ceramic capacitors of 16-V or higher voltage rating and values between 0.1 μF and 0.22 μF are sufficient for C_{BOOT1} and C_{BOOT2} .

7.3.15 Thermal Shutdown

The LM34936 is protected by a thermal shutdown circuit that shuts down the device when the internal junction temperature exceeds 165°C (typical). The soft-start capacitor is discharged when thermal shutdown is triggered

and the gate drivers are disabled. The converter automatically restarts when the junction temperature drops by the thermal shutdown hysteresis of 15°C below the thermal shutdown threshold.

7.4 Device Functional Modes

Please refer to [# 7.3.3](#) for the description of EN/UVLO pin function. [# 7.4.1](#) lists the shutdown, standby, and operating modes for LM34936 as a function of EN/UVLO and VCC voltages.

7.4.1 Shutdown, Standby, and Operating Modes

EN/UVLO	VCC	DEVICE MODE
$EN/UVLO < V_{EN(STBY)}$	—	Shutdown: VCC off, No switching
$V_{EN(STBY)} < EN/UVLO < V_{EN(OP)}$	—	Standby: VCC on, No switching
$EN/UVLO > V_{EN(OP)}$	$VCC < V_{UV(VCC)}$	Standby: VCC on, No switching
$EN/UVLO > V_{EN(OP)}$	$VCC > V_{UV(VCC)}$	Operating: VCC on, Switching enabled

7.4.2 MODE Pin Configuration

The MODE pin is used to select hiccup mode current limit. The MODE selection is based on the voltages at the MODE pin. The MODE voltage is decided by the programming resistor R_{MODE} between MODE and AGND, and the source current out of the MODE pin (I_{MODE}). MODE is latched during startup.

MODE PIN CONNECTION	HICCUP FAULT PROTECTION
R_{MODE} to AGND = 200 k Ω or connect MODE to VCC	No Hiccup
R_{MODE} to AGND = 93.1 k Ω	Hiccup Enabled

8 Application and Implementation

Note

以下应用部分中的信息不属于 TI 器件规格的范围，TI 不担保其准确性和完整性。TI 的客户应负责确定器件是否适用于其应用。客户应验证并测试其设计，以确保系统功能。

8.1 Application Information

The LM34936 is a four-switch buck-boost controller. A quick-start tool on the LM34936 product webpage can be used to design a buck-boost converter using the LM34936. Alternatively, Webench® software can create a complete buck-boost design using the LM34936 and generate bill of materials, estimate efficiency, solution size, and cost of the complete solution. 节 8.2 describes a detailed step-by-step design procedure for a typical application circuit.

8.2 Typical Application

A typical application example is a buck-boost converter operating from a wide input voltage range of 6 V to 30 V and providing a stable 12 V output voltage with current capability of 6 A.

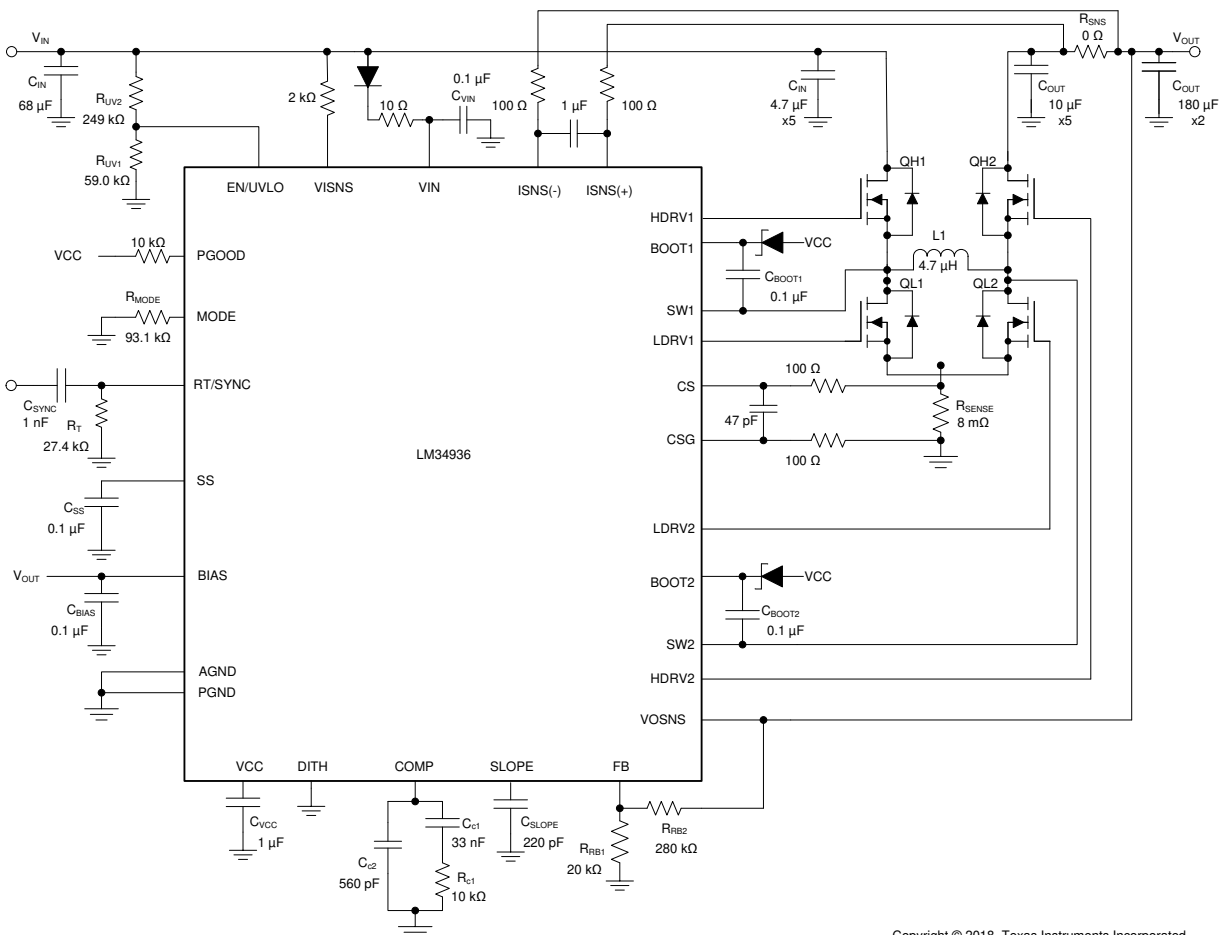

Copyright © 2018, Texas Instruments Incorporated

图 8-1. LM34936 Four-Switch Buck Boost Application Schematic

8.2.1 Design Requirements

For this design example, the following are used as the input parameters.

DESIGN PARAMETER	EXAMPLE VALUE
Input Voltage Range	6 V to 30 V
Output	12 V
Load Current	6 A
Switching Frequency	300 kHz
Mode	CCM, Hiccup

8.2.2 Detailed Design Procedure

8.2.2.1 Custom Design with WEBENCH Tools

[Click here](#) to create a custom design using the LM34936 device with the WEBENCH® Power Designer.

1. Start by entering your V_{IN} , V_{OUT} and I_{OUT} requirements.
2. Optimize your design for key parameters like efficiency, footprint and cost using the optimizer dial and compare this design with other possible solutions from Texas Instruments.
3. WEBENCH Power Designer provides you with a customized schematic along with a list of materials with real time pricing and component availability.
4. In most cases, you will also be able to:
 - Run electrical simulations to see important waveforms and circuit performance,
 - Run thermal simulations to understand the thermal performance of your board,
 - Export your customized schematic and layout into popular CAD formats,
 - Print PDF reports for the design, and share your design with colleagues.
5. Get more information about WEBENCH tools at www.ti.com/webench.

8.2.2.2 Frequency

The switching frequency of LM34936 is set by an R_T resistor connected from RT/SYNC pin to AGND. The R_T resistor required to set the desired frequency is calculated using [方程式 5](#) or [图 6-3](#). A 1% standard resistor of 27.4 k Ω is selected for $F_{sw} = 300$ kHz.

8.2.2.3 V_{OUT}

The output voltage is set using a resistor divider to the FB pin. The internal reference voltage is 0.8 V. Normally the bottom resistor in the resistor divider is selected to be in the 1 k Ω to 100 k Ω range. Select

$$R_{FB1} = 20 \text{ k}\Omega \quad (11)$$

The top resistor in the feedback resistor divider is selected using [方程式 12](#):

$$R_{FB2} = \frac{V_{OUT} - 0.8 \text{ V}}{0.8 \text{ V}} \times R_{FB1} = 280 \text{ k}\Omega \quad (12)$$

8.2.2.4 Inductor Selection

The inductor selection is based on consideration of both buck and boost modes of operation. For the buck mode, inductor selection is based on limiting the peak to peak current ripple ΔI_L to ~40% of the maximum inductor current at the maximum input voltage. The target inductance for the buck mode is:

$$L_{BUCK} = \frac{(V_{IN(MAX)} - V_{OUT}) \times V_{OUT}}{0.4 \times I_{OUT(MAX)} \times F_{sw} \times V_{IN(MAX)}} = 12.7 \mu\text{H} \quad (13)$$

For the boost mode, the inductor selection is based on limiting the peak to peak current ripple ΔI_L to ~30% of the maximum inductor current at the minimum input voltage. The target inductance for the boost mode is:

$$L_{\text{BOOST}} = \frac{V_{\text{IN(MIN)}}^2 \times (V_{\text{OUT}} - V_{\text{IN(MIN)}})}{0.3 \times I_{\text{OUT(MAX)}} \times F_{\text{sw}} \times V_{\text{OUT}}^2} = 2.8 \mu\text{H} \quad (14)$$

In this particular application, the buck inductance is larger. Choosing a larger inductance reduces the ripple current but also increases the size of the inductor. A larger inductor also reduces the achievable bandwidth of the converter by moving the right half plane zero to lower frequencies. Therefore a judicious compromise should be made based on the application requirements. For this design a 4.7- μH inductor is selected. With this inductor selection, the inductor current ripple is 5.1 A, 4.3 A, and 2.1 A, at V_{IN} of 30 V, 24 V, and 6 V respectively.

The maximum average inductor current occurs at the minimum input voltage and maximum load current:

$$I_{\text{L(MAX)}} = \frac{V_{\text{OUT}} \times I_{\text{OUT(MAX)}}}{0.9 \times V_{\text{IN(MIN)}}} = 13.3 \text{ A} \quad (15)$$

where a 90% efficiency is assumed. The peak inductor current occurs at minimum input voltage and is given by:

$$I_{\text{L(PEAK)}} = I_{\text{L(MAX)}} + \frac{V_{\text{IN(MIN)}} \times (V_{\text{OUT}} - V_{\text{IN(MIN)}})}{2 \times L1 \times F_{\text{sw}} \times V_{\text{OUT}}} = 14.4 \text{ A} \quad (16)$$

To ensure sufficient output current, the current limit threshold must be set to allow the maximum load current in boost operation. The inductor peak current during overload depends on the current limit resistor R_{SENSE} (refer to the sub-section on selecting R_{SENSE}). The peak inductor current in current limit when in boost mode is given by:

$$I_{\text{L(PEAK, ILIMIT, BOOST)}} = \frac{120 \text{ mV}}{R_{\text{SENSE}}} \quad (17)$$

The peak inductor current in current limit when in buck mode happens at high input voltage and is given by:

$$I_{\text{L(PEAK, ILIMIT, BUCK)}} = \frac{80 \text{ mV}}{R_{\text{SENSE}}} + \frac{(V_{\text{IN(MAX)}} - V_{\text{OUT}})}{L1 \times F_{\text{sw}}} \times \left(\frac{V_{\text{OUT}}}{V_{\text{IN(MAX)}}} \right) \quad (18)$$

The peak inductor current in current limit is 15 A and 16.5 A in boost mode and buck mode respectively. The inductor should be selected to handle this current.

8.2.2.5 Output Capacitor

In the boost mode, the output capacitor conducts high ripple current. The output capacitor RMS ripple current is given by 方程式 19 where the minimum V_{IN} corresponds to the maximum capacitor current.

$$I_{\text{COUT(RMS)}} = I_{\text{OUT}} \times \sqrt{\frac{V_{\text{OUT}}}{V_{\text{IN}}} - 1} \quad (19)$$

In this example the maximum output ripple RMS current is $I_{\text{COUT(RMS)}} = 6 \text{ A}$. A 5-m Ω output capacitor ESR causes an output ripple voltage of 60 mV as given by:

$$\Delta V_{\text{RIPPLE(ESR)}} = \frac{I_{\text{OUT}} \times V_{\text{OUT}}}{V_{\text{IN(MIN)}}} \times \text{ESR} \quad (20)$$

A 400 μF output capacitor causes a capacitive ripple voltage of 25 mV as given by:

$$\Delta V_{\text{RIPPLE(COUT)}} = \frac{I_{\text{OUT}} \times \left(1 - \frac{V_{\text{IN(MIN)}}}{V_{\text{OUT}}}\right)}{C_{\text{OUT}} \times F_{\text{SW}}} \quad (21)$$

Typically a combination of ceramic and bulk capacitors is needed to provide low ESR and high ripple current capacity. The complete schematic in [图 8-1](#) at the end of this section shows a good starting point for C_{OUT} for typical applications.

8.2.2.6 Input Capacitor

In the buck mode, the input capacitor supplies high ripple current. The RMS current in the input capacitor is given by:

$$I_{\text{CIN(RMS)}} = I_{\text{OUT}} \sqrt{D \times (1-D)} \quad (22)$$

The maximum RMS current occurs at $D = 0.5$, which gives $I_{\text{CIN(RMS)}} = I_{\text{OUT}}/2 = 3 \text{ A}$. A combination of ceramic and bulk capacitors should be used to provide short path for high di/dt current and to reduce the output voltage ripple. The complete schematic in [图 8-1](#) is a good starting point for C_{IN} for typical applications.

8.2.2.7 Sense Resistor (R_{SENSE})

The current sense resistor between the CS and CSG pins should be selected to ensure that current limit is set high enough for both buck and boost modes of operation. For the buck operation, the current limit resistor is given by:

$$R_{\text{SENSE(BUCK)}} = \frac{80 \text{ mV}}{I_{\text{OUT(MAX)}}} = 13 \text{ m}\Omega \quad (23)$$

For the boost mode of operation, the current limit resistor is given by:

$$R_{\text{SENSE(BOOST)}} = \frac{120 \text{ mV}}{I_{\text{L(PEAK)}}} = 8.3 \text{ m}\Omega \quad (24)$$

The closest standard value of $R_{\text{SENSE}} = 8 \text{ m}\Omega$ is selected based on the boost mode operation.

The maximum power dissipation in R_{SENSE} happens at $V_{\text{IN(MIN)}}$:

$$P_{\text{RSENSE(MAX)}} = \left(\frac{120 \text{ mV}}{R_{\text{SENSE}}}\right)^2 \cdot R_{\text{SENSE}} \cdot \left(1 - \frac{V_{\text{IN(MIN)}}}{V_{\text{OUT}}}\right) = 0.9 \text{ W} \quad (25)$$

Therefore, a sense resistor with 2 W power rating will be sufficient for this application.

For some application circuits, it may be required to add a filter network to attenuate noise in the CS and CSG sense lines. Please see [图 8-1](#) for typical values. The filter resistance should not exceed $100 \text{ }\Omega$.

8.2.2.8 Slope Compensation

For stable current loop operation and to avoid sub-harmonic oscillations, the slope capacitor should be selected based on [方程式 26](#):

$$C_{\text{SLOPE}} = g_{\text{mSLOPE}} \times \frac{L1}{R_{\text{SENSE}} \times A_{\text{CS}}} = 2 \text{ }\mu\text{S} \times \frac{4.7 \text{ }\mu\text{H}}{8 \text{ m}\Omega \times 5} = 235 \text{ pF} \quad (26)$$

This slope compensation results in “dead-beat” operation, in which the current loop disturbances die out in one switching cycle. Theoretically a current mode loop is stable with half the “dead-beat” slope (twice the

calculated slope capacitor value in [方程式 26](#)). A smaller slope capacitor results in larger slope signal which is better for noise immunity in the transition region ($V_{IN} \sim V_{OUT}$). A larger slope signal, however, restricts the achievable input voltage range for a given output voltage, switching frequency, and inductor. For this design $C_{SLOPE} = 220$ pF is selected for better transition region behavior while still providing the required V_{IN} range. This selection of slope capacitor, inductor, switching frequency, and inductor satisfies the COMP range limitation explained in [# 7.3.13](#).

8.2.2.9 UVLO

The UVLO resistor divider must be designed for turn-on below 6V. Selecting a $R_{UV2} = 249$ k Ω gives a UVLO hysteresis of 0.8 V based on [方程式 2](#). The lower UVLO resistor is the selected using [方程式 27](#):

$$R_{UV1} = \frac{R_{UV2} \times V_{EN(OP)}}{V_{IN(UV)} + I_{EN(STBY)} \times R_{UV2} - V_{EN(OP)}} \quad (27)$$

A standard value of 59.0 k Ω is selected for R_{UV1} .

When programming the UVLO threshold for lower input voltage operation, it is important to choose MOSFETs with gate (Miller) plateau voltage lower than the minimum V_{IN} .

8.2.2.10 Soft-Start Capacitor

The soft-start time is programmed using the soft-start capacitor. The relationship between C_{SS} and the soft-start time is given by:

$$t_{ss} = \frac{C_{SS} \times V_{REF}}{I_{SS}} \quad (28)$$

$C_{SS} = 0.1$ μ F gives a soft-start time of 16 ms.

8.2.2.11 Dither Capacitor

The dither capacitor sets the modulation frequency of the frequency dithering around the nominal switching frequency. A larger C_{DITH} results in lower modulation frequency. For proper operation the modulation frequency (F_{MOD}) must be much lower than the switching frequency. Use [方程式 29](#) to select C_{DITH} for the target modulation frequency.

$$C_{DITH} = \frac{10 \mu A}{F_{MOD} \times 0.24 V} \quad (29)$$

For the current design dithering is not being implemented. Therefore a 0 Ω resistor from the DITH pin to AGND disables this feature.

8.2.2.12 MOSFETs QH1 and QL1

The input side MOSFETs QH1 and QL1 need to withstand the maximum input voltage of 30 V. In addition they must withstand the transient spikes at SW1 during switching. Therefore QH1 and QL1 should be rated for 60 V or higher. The gate plateau voltages of the MOSFETs should be smaller than the minimum input voltage of the converter, otherwise the MOSFETs may not fully enhance during startup or overload conditions.

The power loss in QH1 in the boost mode of operation is approximated by:

$$P_{COND(QH1)} = \left(I_{OUT} \cdot \frac{V_{OUT}}{V_{IN}} \right)^2 \cdot R_{DSON(QH1)} \quad (30)$$

The power loss in QH1 in the buck mode of operation consists of both conduction and switching loss components given by [方程式 31](#) and [方程式 32](#) respectively:

$$P_{\text{COND}(Q_{H1})} = \left(\frac{V_{\text{OUT}}}{V_{\text{IN}}} \right) \cdot I_{\text{OUT}}^2 \cdot R_{\text{DSON}(Q_{H1})} \quad (31)$$

$$P_{\text{SW}(Q_{H1})} = \frac{1}{2} \cdot V_{\text{IN}} \cdot I_{\text{OUT}} \cdot (t_r + t_f) \cdot F_{\text{sw}} \quad (32)$$

The rise (t_r) and the fall (t_f) times are based on the MOSFET datasheet information or measured in the lab. Typically a MOSFET with smaller R_{DSON} (smaller conduction loss) will have longer rise and fall times (larger switching loss).

The power loss in QL1 in the buck mode of operation is shown in [方程式 33](#):

$$P_{\text{COND}(Q_{L1})} = \left(1 - \frac{V_{\text{OUT}}}{V_{\text{IN}}} \right) \cdot I_{\text{OUT}}^2 \cdot R_{\text{DSON}(Q_{L1})} \quad (33)$$

8.2.2.13 MOSFETs QH2 and QL2

The output side MOSFETs QH2 and QL2 see the output voltage of 12 V and additional transient spikes at SW2 during switching. Therefore QH2 and QL2 should be rated for 20 V or more. The gate plateau voltages of the MOSFETs should be smaller than the minimum input voltage of the converter, otherwise the MOSFETs may not fully enhance during startup or overload conditions.

The power loss in QH2 in the buck mode of operation is approximated by:

$$P_{\text{COND}(Q_{H2})} = I_{\text{OUT}}^2 \cdot R_{\text{DSON}(Q_{H2})} \quad (34)$$

The power loss in QL2 in the boost mode of operation consists of both conduction and switching loss components given by [方程式 35](#) and [方程式 36](#) respectively:

$$P_{\text{COND}(Q_{L2})} = \left(1 - \frac{V_{\text{IN}}}{V_{\text{OUT}}} \right) \cdot \left(I_{\text{OUT}} \cdot \frac{V_{\text{OUT}}}{V_{\text{IN}}} \right)^2 \cdot R_{\text{DSON}(Q_{L2})} \quad (35)$$

$$P_{\text{SW}(Q_{L2})} = \frac{1}{2} \cdot V_{\text{OUT}} \cdot \left(I_{\text{OUT}} \cdot \frac{V_{\text{OUT}}}{V_{\text{IN}}} \right) \cdot (t_r + t_f) \cdot F_{\text{sw}} \quad (36)$$

The rise (t_r) and the fall (t_f) times can be based on the MOSFET datasheet information or measured in the lab. Typically a MOSFET with smaller R_{DSON} (lower conduction loss) has longer rise and fall times (larger switching loss).

The power loss in QH2 in the boost mode of operation is shown in [方程式 37](#):

$$P_{\text{COND}(Q_{H2})} = \frac{V_{\text{IN}}}{V_{\text{OUT}}} \cdot \left(I_{\text{OUT}} \cdot \frac{V_{\text{OUT}}}{V_{\text{IN}}} \right)^2 \cdot R_{\text{DSON}(Q_{H2})} \quad (37)$$

8.2.2.14 Frequency Compensation

This section presents the control loop compensation design procedure for the LM34936 buck-boost controller. The LM34936 operates mainly in buck or boost modes, separated by a transition region, and therefore the control loop design is done for both buck and boost operating modes. Then a final selection of compensation is made based on the mode that is more restrictive from a loop stability point of view. Typically for a converter designed to go deep into both buck and boost operating regions, the boost compensation design is more restrictive due to the presence of a right half plane zero (RHPZ) in the boost mode.

The boost power stage output pole location is given by:

$$f_{p1(\text{boost})} = \frac{1}{2\pi} \left(\frac{2}{R_{\text{OUT}} \times C_{\text{OUT}}} \right) = 398 \text{ Hz} \quad (38)$$

where $R_{\text{OUT}} = 2 \Omega$ corresponds to the maximum load of 6 A.

The boost power stage ESR zero location is given by:

$$f_{z1} = \frac{1}{2\pi} \left(\frac{1}{R_{\text{ESR}} \times C_{\text{OUT}}} \right) = 79.6 \text{ kHz} \quad (39)$$

The boost power stage RHP zero location is given by:

$$f_{\text{RHP}} = \frac{1}{2\pi} \left(\frac{R_{\text{OUT}} \times (1 - D_{\text{MAX}})^2}{L1} \right) = 16.9 \text{ kHz} \quad (40)$$

where D_{MAX} is the maximum duty cycle at the minimum V_{IN} .

The buck power stage output pole location is given by:

$$f_{p1(\text{buck})} = \frac{1}{2\pi} \left(\frac{1}{R_{\text{OUT}} \times C_{\text{OUT}}} \right) = 199 \text{ Hz} \quad (41)$$

The buck power stage ESR zero location is the same as the boost power stage ESR zero.

It is clear from [方程式 40](#) that RHP zero is the main factor limiting the achievable bandwidth. For a robust design the crossover frequency should be less than 1/3 of the RHP zero frequency. Given the position of the RHP zero, a reasonable target bandwidth in boost operation is around 4 kHz:

$$f_{\text{bw}} = 4 \text{ kHz} \quad (42)$$

For some power stages, the boost RHP zero might not be as restrictive. This happens when the boost maximum duty cycle (D_{MAX}) is small, or when a really small inductor is used. In those cases, compare the limits posed by the RHP zero ($f_{\text{RHP}}/3$) with 1/20 of the switching frequency and use the smaller of the two values as the achievable bandwidth.

The compensation zero can be placed at 1.5 times the boost output pole frequency. Keep in mind that this locates the zero at 3 times the buck output pole frequency which results in approximately 30 degrees of phase loss before crossover of the buck loop and 15 degrees of phase loss at intermediate frequencies for the boost loop:

$$f_{\text{zc}} = 600 \text{ Hz} \quad (43)$$

If the crossover frequency is well below the RHP zero and the compensation zero is placed well below the crossover, the compensation gain resistor R_{c1} is calculated using the approximation:

$$R_{\text{c1}} = \frac{2\pi \times f_{\text{bw}}}{\text{gm}_{\text{EA}}} \times \frac{R_{\text{FB1}} + R_{\text{FB2}}}{R_{\text{FB1}}} \times \frac{A_{\text{CS}} \times R_{\text{SENSE}} \times C_{\text{OUT}}}{1 - D_{\text{MAX}}} = 9.49 \text{ k}\Omega \quad (44)$$

where D_{MAX} is the maximum duty cycle at the minimum V_{IN} in boost mode and A_{CS} is the current sense amplifier gain. The compensation capacitor C_{c1} is then calculated from:

$$C_{\text{c1}} = \frac{1}{2 \times \pi \times f_{\text{zc}} \times R_{\text{c1}}} = 27.9 \text{ nF} \quad (45)$$

The standard values of compensation components are selected to be $R_{c1} = 10 \text{ k}\Omega$ and $C_{c1} = 33 \text{ nF}$.

A high frequency pole (f_{pc2}) is placed using a capacitor (C_{c2}) in parallel with R_{c1} and C_{c1} . Set the frequency of this pole at 7 to 10 times of f_{bw} to provide attenuation of switching ripple and noise on COMP while avoiding excessive phase loss at the crossover frequency. For a target $f_{pc2} = 28 \text{ kHz}$, C_{c2} is calculated using this equation:

$$C_{c2} = \frac{1}{2 \times \pi \times f_{pc2} \times R_{c1}} = 568 \text{ pF} \quad (46)$$

Select a standard value of 560 pF for C_{c2} . These values provide a good starting point for the compensation design. Each design should be tuned in the lab to achieve the desired balance between stability margin across the operating range and transient response time.

8.2.3 Application Curves



图 8-2. Efficiency vs Load



图 8-3. Efficiency vs Input Voltage

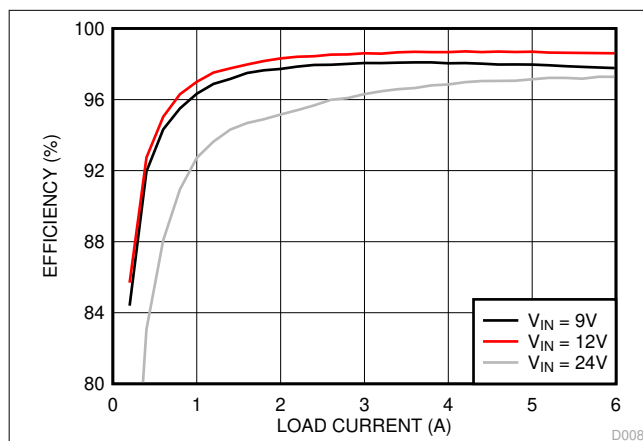

图 8-4. Output Voltage Ripple

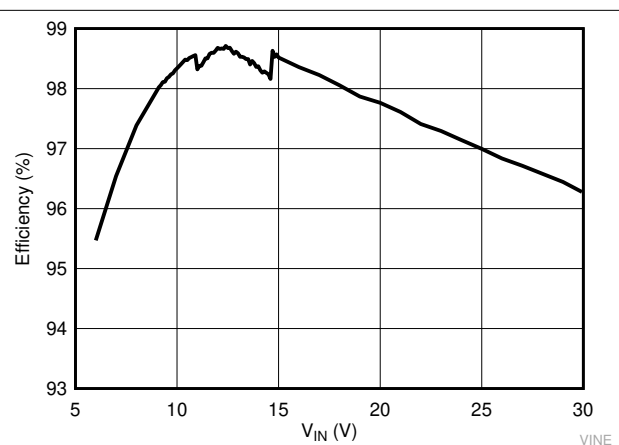

图 8-5. Line Transient Response (8 V - 24 V, $I_{OUT} = 2 \text{ A}$)

9 Power Supply Recommendations

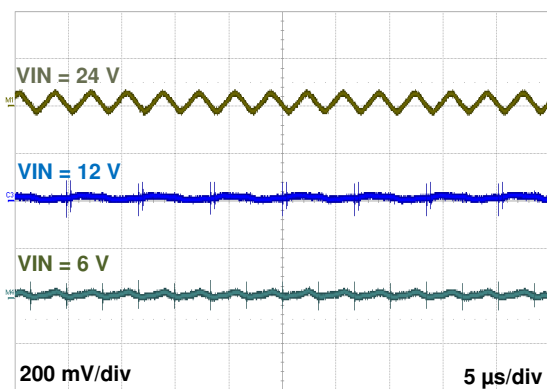
The LM34936 is a power management device. The power supply for the device is any dc voltage source within the specified input range. The supply should also be capable of supplying sufficient current based on the maximum inductor current in boost mode operation. The input supply should be bypassed with additional electrolytic capacitor at the input of the application board to avoid ringing due to parasitic impedance of the connecting cables.

10 Layout

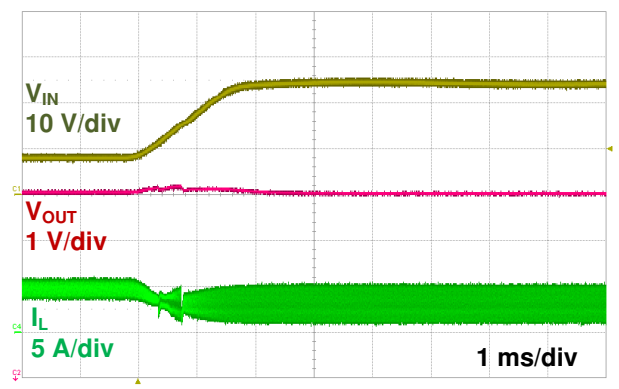
10.1 Layout Guidelines

The basic PCB board layout requires separation of sensitive signal and power paths. This checklist must be followed to get good performance for a well designed board.

- Place the power components including the input filter capacitor C_{IN} , the power MOSFETs QL1 and QH1, and the sense resistor R_{SENSE} close together to minimize the loop area for input switching current in buck operation.
- Place the power components including the output filter capacitor C_{OUT} , the power MOSFETs QL2 and QH2, and the sense resistor R_{SENSE} close together to minimize the loop area for output switching current in boost operation.
- Use a combination of bulk capacitors and smaller ceramic capacitors with low series impedance for the input and output capacitors. Place the smaller capacitors closer to the IC to provide a low impedance path for high di/dt switching currents.
- Minimize the SW1 and SW2 loop areas as these are high dv/dt nodes.
- Layout the gate drive traces and return paths as directly as possible. Layout the forward and return traces close together, either running side by side or on top of each other on adjacent layers to minimize the inductance of the gate drive path.
- Use Kelvin connections to R_{SENSE} for the current sense signals CS and CSG and run lines in parallel from the R_{SENSE} terminals to the IC pins. Avoid crossing noisy areas such as SW1 and SW2 nodes or high-side gate drive traces. Place the filter capacitor for the current sense signal as close to the IC pins as possible.
- Place the C_{IN} , C_{OUT} , and R_{SENSE} ground pins as close as possible with thick ground trace and/or planes on multiple layers.
- Place the VCC bypass capacitor close to the controller IC, between the VCC and PGND pins. A 1- μ F ceramic capacitor is typically used.
- Place the BIAS bypass capacitor close to the controller IC, between the BIAS and PGND pins. A 0.1- μ F ceramic capacitor is typically used.
- Place the BOOT1 bootstrap capacitor close to the IC and connect directly to the BOOT1 to SW1 pins.
- Place the BOOT2 bootstrap capacitor close to the IC and connect directly to the BOOT2 to SW2 pins.
- Bypass the V_{IN} pin to AGND with a low ESR ceramic capacitor located close to the controller IC. A 0.1 μ F ceramic capacitor is typically used. When using external BIAS, use a diode between input rails and V_{IN} pins to prevent reverse conduction when $V_{IN} < VCC$.
- Connect the feedback resistor divider between the C_{OUT} positive terminal and AGND pin of the IC. Place the components close to the FB pin.
- Use care to separate the power and signal paths so that no power or switching current flows through the AGND connections which can either corrupt the COMP, SLOPE, or SYNC signals, or cause dc offset in the FB sense signal. The PGND and AGND traces can be connected near the PGND pin, near the VCC capacitor PGND connection, or near the PGND connection of the CS, CSG pin current sense resistor.
- When using the average current loop, divide the overall capacitor (C_{IN} or C_{OUT}) between the two sides of the sense resistor to ensure small cycle-by-cycle ripple. Place the average current loop filter capacitor close to the IC between the ISNS(+) and ISNS(-) pins.

10.2 Layout Example



图 10-1. LM34936 Power Stage Layout

11 Device and Documentation Support

11.1 Device Support

11.1.1 第三方产品免责声明

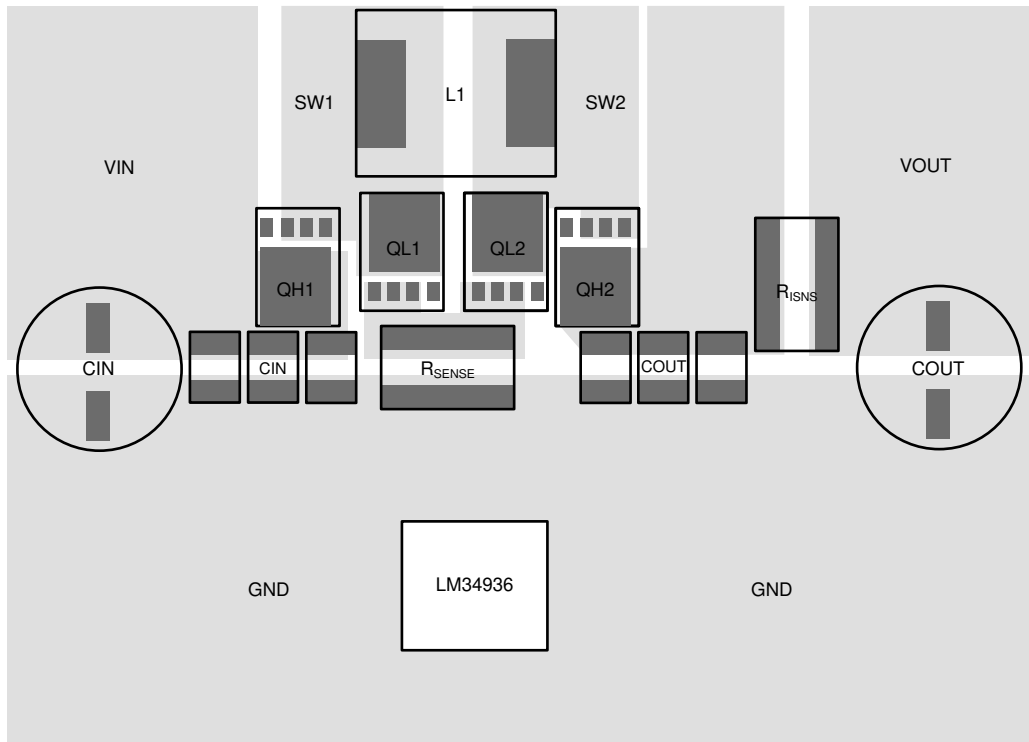
TI 发布的与第三方产品或服务有关的信息，不能构成与此类产品或服务或保修的适用性有关的认可，不能构成此类产品或服务单独或与任何 TI 产品或服务一起的表示或认可。

11.1.2 Development Support

11.1.2.1 Custom Design with WEBENCH Tools

[Click here](#) to create a custom design using the LM34936 device with the WEBENCH® Power Designer.

1. Start by entering your V_{IN} , V_{OUT} and I_{OUT} requirements.
2. Optimize your design for key parameters like efficiency, footprint and cost using the optimizer dial and compare this design with other possible solutions from Texas Instruments.
3. WEBENCH Power Designer provides you with a customized schematic along with a list of materials with real time pricing and component availability.
4. In most cases, you will also be able to:
 - Run electrical simulations to see important waveforms and circuit performance,
 - Run thermal simulations to understand the thermal performance of your board,
 - Export your customized schematic and layout into popular CAD formats,
 - Print PDF reports for the design, and share your design with colleagues.
5. Get more information about WEBENCH tools at www.ti.com/webench.

11.2 Documentation Support

11.2.1 Related Documentation

Please visit TI homepage for latest technical document including application notes, user guides, and reference designs.

IC Package Thermal Metrics application report, [Semiconductor and IC Package Thermal Metrics](#).

11.3 接收文档更新通知

要接收文档更新通知，请导航至 ti.com 上的器件产品文件夹。点击 [订阅更新](#) 进行注册，即可每周接收产品信息更改摘要。有关更改的详细信息，请查看任何已修订文档中包含的修订历史记录。

11.4 支持资源

[TI E2E™ 支持论坛](#) 是工程师的重要参考资料，可直接从专家获得快速、经过验证的解答和设计帮助。搜索现有解答或提出自己的问题可获得所需的快速设计帮助。

链接的内容由各个贡献者“按原样”提供。这些内容并不构成 TI 技术规范，并且不一定反映 TI 的观点；请参阅 TI 的《使用条款》。

11.5 Trademarks

PowerPAD™ is a trademark of Texas Instruments.

TI E2E™ is a trademark of Texas Instruments.

Webench®, WEBENCH® and are registered trademarks of Texas Instruments.

所有商标均为其各自所有者的财产。

11.6 Electrostatic Discharge Caution



This integrated circuit can be damaged by ESD. Texas Instruments recommends that all integrated circuits be handled with appropriate precautions. Failure to observe proper handling and installation procedures can cause damage.

ESD damage can range from subtle performance degradation to complete device failure. Precision integrated circuits may be more susceptible to damage because very small parametric changes could cause the device not to meet its published specifications.

11.7 术语表

[TI 术语表](#) 本术语表列出并解释了术语、首字母缩略词和定义。

12 Mechanical, Packaging, and Orderable Information

The following pages include mechanical, packaging, and orderable information. This information is the most current data available for the designated devices. This data is subject to change without notice and revision of this document. For browser-based versions of this data sheet, refer to the left-hand navigation.

重要声明和免责声明

TI 提供技术和可靠性数据 (包括数据表)、设计资源 (包括参考设计)、应用或其他设计建议、网络工具、安全信息和其他资源, 不保证没有瑕疵且不做任何明示或暗示的担保, 包括但不限于对适销性、某特定用途方面的适用性或不侵犯任何第三方知识产权的暗示担保。

这些资源可供使用 TI 产品进行设计的熟练开发人员使用。您将自行承担以下全部责任: (1) 针对您的应用选择合适的 TI 产品, (2) 设计、验证并测试您的应用, (3) 确保您的应用满足相应标准以及任何其他安全、安保或其他要求。这些资源如有变更, 恕不另行通知。TI 授权您仅可将这些资源用于研发本资源所述的 TI 产品的应用。严禁对这些资源进行其他复制或展示。您无权使用任何其他 TI 知识产权或任何第三方知识产权。您应全额赔偿因在这些资源的使用中对 TI 及其代表造成的任何索赔、损害、成本、损失和债务, TI 对此概不负责。

TI 提供的产品受 TI 的销售条款 (<https://www.ti.com/legal/termsofsale.html>) 或 [ti.com](https://www.ti.com) 上其他适用条款/TI 产品随附的其他适用条款的约束。TI 提供这些资源并不会扩展或以其他方式更改 TI 针对 TI 产品发布的适用的担保或担保免责声明。

邮寄地址: Texas Instruments, Post Office Box 655303, Dallas, Texas 75265

Copyright © 2021, 德州仪器 (TI) 公司

PACKAGING INFORMATION

Orderable Device	Status (1)	Package Type	Package Drawing	Pins	Package Qty	Eco Plan (2)	Lead finish/ Ball material (6)	MSL Peak Temp (3)	Op Temp (°C)	Device Marking (4/5)	Samples
LM34936RHFR	ACTIVE	VQFN	RHF	28	3000	RoHS & Green	NIPDAU	Level-1-260C-UNLIM	-40 to 125	LM34936	Samples
LM34936RHFT	ACTIVE	VQFN	RHF	28	250	RoHS & Green	NIPDAU	Level-1-260C-UNLIM	-40 to 125	LM34936	Samples

(1) The marketing status values are defined as follows:

ACTIVE: Product device recommended for new designs.

LIFEBUY: TI has announced that the device will be discontinued, and a lifetime-buy period is in effect.

NRND: Not recommended for new designs. Device is in production to support existing customers, but TI does not recommend using this part in a new design.

PREVIEW: Device has been announced but is not in production. Samples may or may not be available.

OBSOLETE: TI has discontinued the production of the device.

(2) **RoHS:** TI defines "RoHS" to mean semiconductor products that are compliant with the current EU RoHS requirements for all 10 RoHS substances, including the requirement that RoHS substance do not exceed 0.1% by weight in homogeneous materials. Where designed to be soldered at high temperatures, "RoHS" products are suitable for use in specified lead-free processes. TI may reference these types of products as "Pb-Free".

RoHS Exempt: TI defines "RoHS Exempt" to mean products that contain lead but are compliant with EU RoHS pursuant to a specific EU RoHS exemption.

Green: TI defines "Green" to mean the content of Chlorine (Cl) and Bromine (Br) based flame retardants meet JS709B low halogen requirements of <=1000ppm threshold. Antimony trioxide based flame retardants must also meet the <=1000ppm threshold requirement.

(3) MSL, Peak Temp. - The Moisture Sensitivity Level rating according to the JEDEC industry standard classifications, and peak solder temperature.

(4) There may be additional marking, which relates to the logo, the lot trace code information, or the environmental category on the device.

(5) Multiple Device Markings will be inside parentheses. Only one Device Marking contained in parentheses and separated by a "~" will appear on a device. If a line is indented then it is a continuation of the previous line and the two combined represent the entire Device Marking for that device.

(6) Lead finish/Ball material - Orderable Devices may have multiple material finish options. Finish options are separated by a vertical ruled line. Lead finish/Ball material values may wrap to two lines if the finish value exceeds the maximum column width.

Important Information and Disclaimer:The information provided on this page represents TI's knowledge and belief as of the date that it is provided. TI bases its knowledge and belief on information provided by third parties, and makes no representation or warranty as to the accuracy of such information. Efforts are underway to better integrate information from third parties. TI has taken and continues to take reasonable steps to provide representative and accurate information but may not have conducted destructive testing or chemical analysis on incoming materials and chemicals. TI and TI suppliers consider certain information to be proprietary, and thus CAS numbers and other limited information may not be available for release.

In no event shall TI's liability arising out of such information exceed the total purchase price of the TI part(s) at issue in this document sold by TI to Customer on an annual basis.

OTHER QUALIFIED VERSIONS OF LM34936 :

- Automotive : [LM34936-Q1](#)

NOTE: Qualified Version Definitions:

- Automotive - Q100 devices qualified for high-reliability automotive applications targeting zero defects

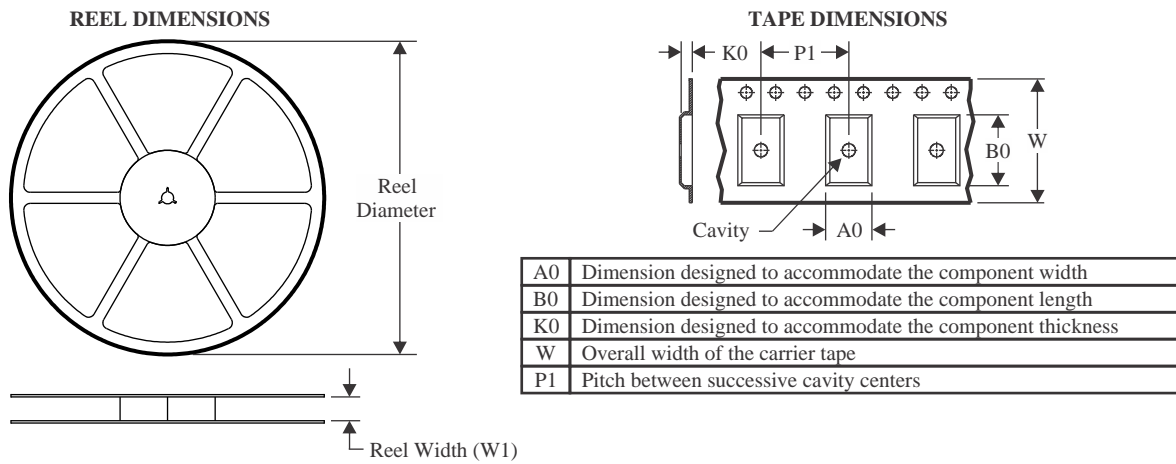
TAPE AND REEL INFORMATION

QUADRANT ASSIGNMENTS FOR PIN 1 ORIENTATION IN TAPE

*All dimensions are nominal

Device	Package Type	Package Drawing	Pins	SPQ	Reel Diameter (mm)	Reel Width W1 (mm)	A0 (mm)	B0 (mm)	K0 (mm)	P1 (mm)	W (mm)	Pin1 Quadrant
LM34936RHFR	VQFN	RHF	28	3000	330.0	12.4	4.3	5.3	1.3	8.0	12.0	Q1
LM34936RHFT	VQFN	RHF	28	250	180.0	12.4	4.3	5.3	1.3	8.0	12.0	Q1

TAPE AND REEL BOX DIMENSIONS

*All dimensions are nominal

Device	Package Type	Package Drawing	Pins	SPQ	Length (mm)	Width (mm)	Height (mm)
LM34936RHFR	VQFN	RHF	28	3000	367.0	367.0	35.0
LM34936RHFT	VQFN	RHF	28	250	210.0	185.0	35.0

RHF 28

GENERIC PACKAGE VIEW

VQFN - 1.0 mm max height

PLASTIC QUAD FLATPACK - NO LEAD

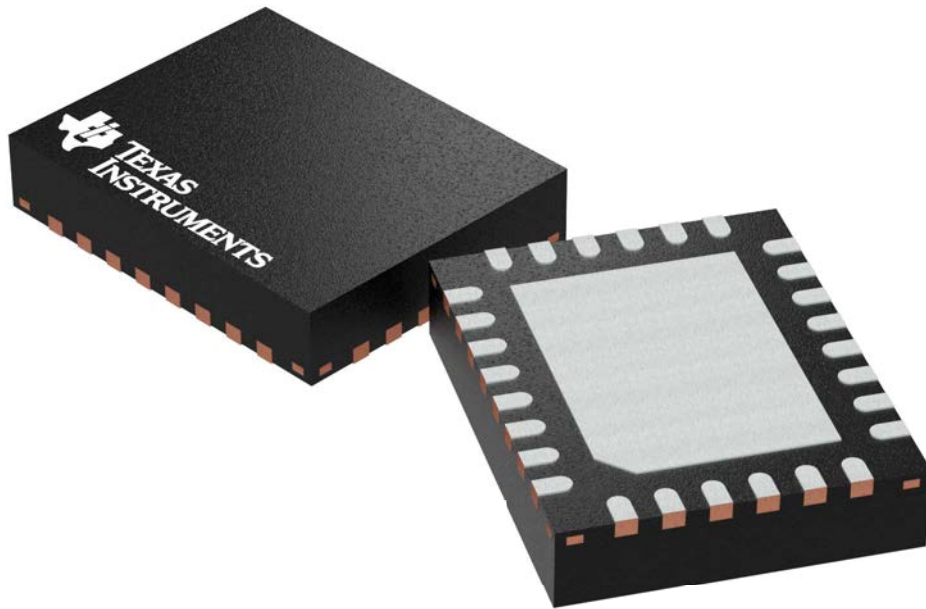

Images above are just a representation of the package family, actual package may vary.
Refer to the product data sheet for package details.

4204845/J

EXAMPLE BOARD LAYOUT

RHF0028A

VQFN - 1.0 mm max height

PLASTIC QUAD FLATPACK - NO LEAD

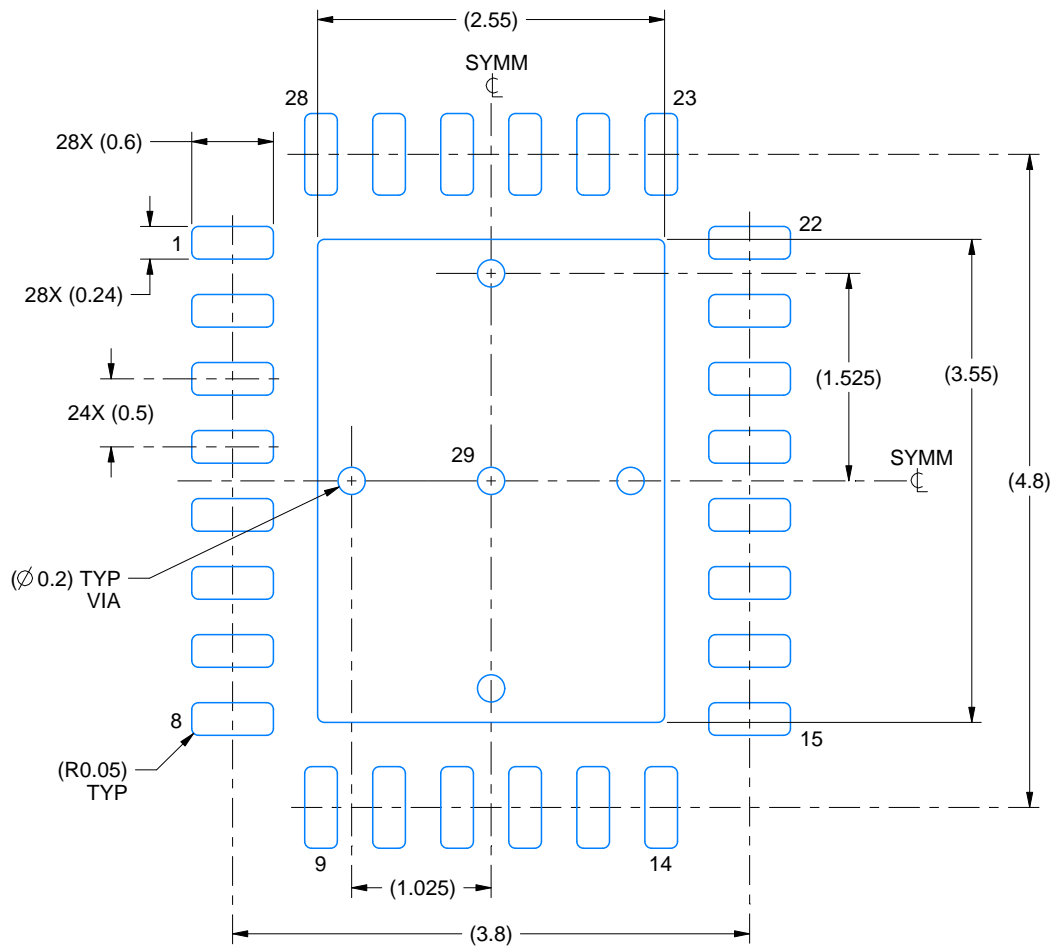

LAND PATTERN EXAMPLE
SCALE:18X

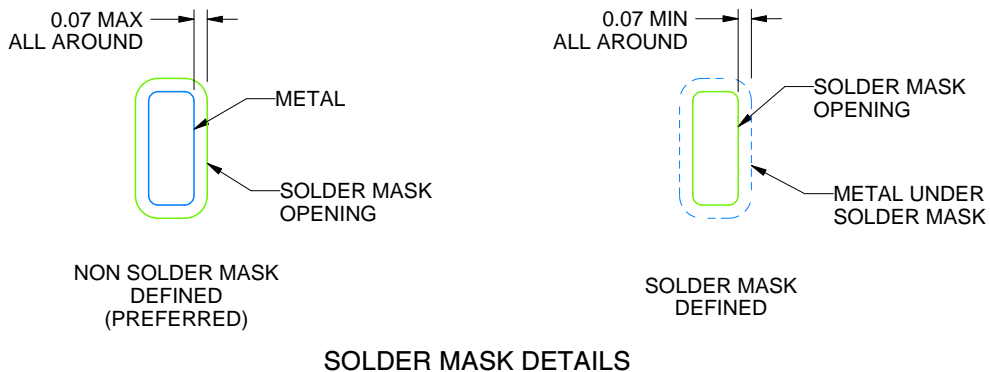

SOLDER MASK DETAILS

4220383/A 11/2016

NOTES: (continued)

4. This package is designed to be soldered to a thermal pad on the board. For more information, see Texas Instruments literature number SLUA271 (www.ti.com/lit/slua271).
5. Vias are optional depending on application, refer to device data sheet. If any vias are implemented, refer to their locations shown on this view. It is recommended that vias under paste be filled, plugged or tented.

EXAMPLE STENCIL DESIGN

RHF0028A

VQFN - 1.0 mm max height

PLASTIC QUAD FLATPACK - NO LEAD

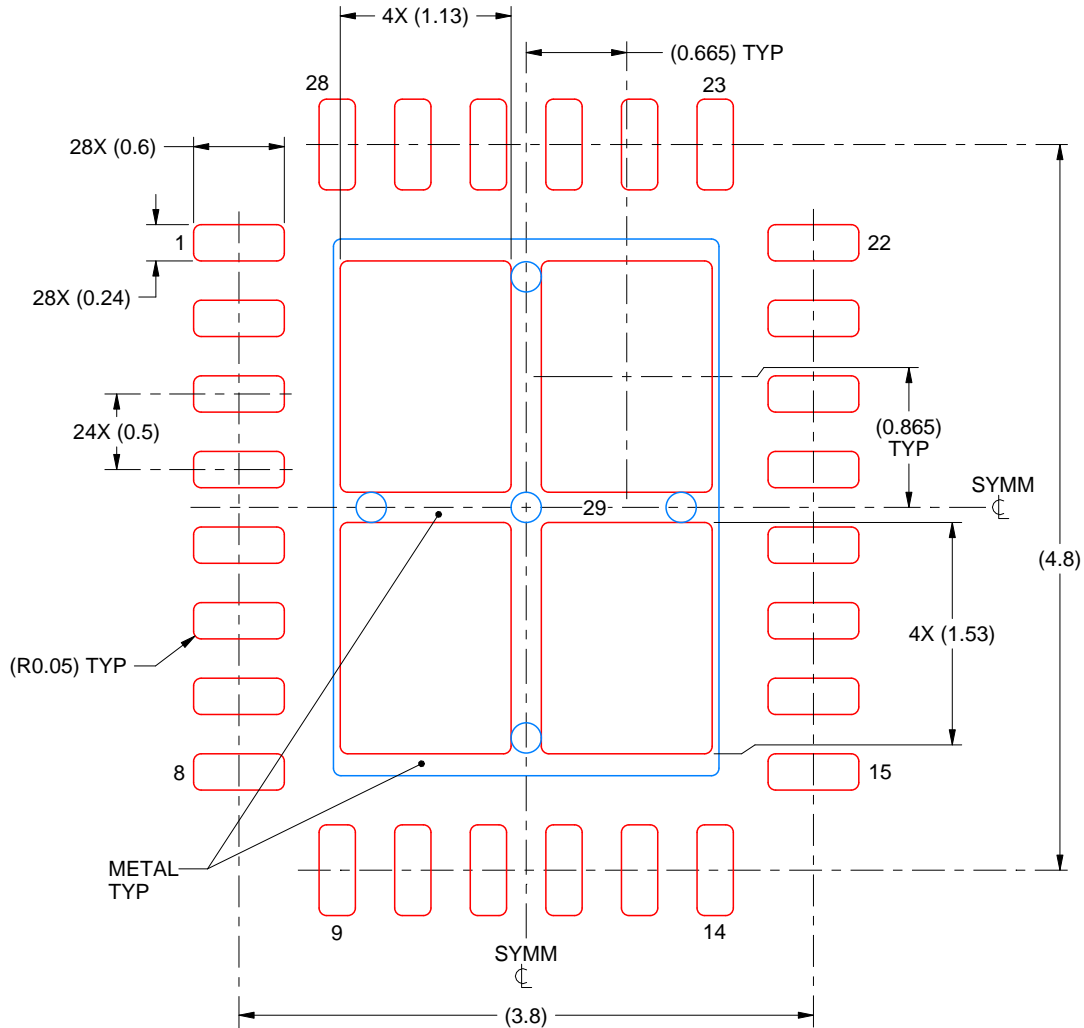

SOLDER PASTE EXAMPLE
 BASED ON 0.125 mm THICK STENCIL

EXPOSED PAD 29
 76% PRINTED SOLDER COVERAGE BY AREA UNDER PACKAGE
 SCALE:20X

4220383/A 11/2016

NOTES: (continued)

6. Laser cutting apertures with trapezoidal walls and rounded corners may offer better paste release. IPC-7525 may have alternate design recommendations.

重要声明和免责声明

TI“按原样”提供技术和可靠性数据（包括数据表）、设计资源（包括参考设计）、应用或其他设计建议、网络工具、安全信息和其他资源，不保证没有瑕疵且不做任何明示或暗示的担保，包括但不限于对适销性、某特定用途方面的适用性或不侵犯任何第三方知识产权的暗示担保。

这些资源可供使用 TI 产品进行设计的熟练开发人员使用。您将自行承担以下全部责任：(1) 针对您的应用选择合适的 TI 产品，(2) 设计、验证并测试您的应用，(3) 确保您的应用满足相应标准以及任何其他功能安全、信息安全、监管或其他要求。

这些资源如有变更，恕不另行通知。TI 授权您仅可将这些资源用于研发本资源所述的 TI 产品的应用。严禁对这些资源进行其他复制或展示。您无权使用任何其他 TI 知识产权或任何第三方知识产权。您应全额赔偿因在这些资源的使用中对 TI 及其代表造成的任何索赔、损害、成本、损失和债务，TI 对此概不负责。

TI 提供的产品受 [TI 的销售条款](#) 或 [ti.com](#) 上其他适用条款/TI 产品随附的其他适用条款的约束。TI 提供这些资源并不会扩展或以其他方式更改 TI 针对 TI 产品发布的适用的担保或担保免责声明。

TI 反对并拒绝您可能提出的任何其他或不同的条款。

邮寄地址：Texas Instruments, Post Office Box 655303, Dallas, Texas 75265

Copyright © 2022，德州仪器 (TI) 公司