

## LMG2610 用于有源钳位反激式转换器的集成 650V GaN 半桥

### 1 特性

- 650V GaN 功率 FET 半桥
- 170mΩ 低侧和 248mΩ 高侧 GaN FET
- 具有低传播延迟和可调节导通压摆率控制的集成栅极驱动器
- 具有高带宽和高精度的电流检测仿真
- 低侧/高侧栅极驱动互锁
- 高侧栅极驱动信号电平转换器
- 智能开关自举二极管功能
- 高侧启动： $< 8\mu\text{s}$
- 低侧/高侧逐周期过流保护
- 通过  $\overline{\text{FLT}}$  引脚报告实现过热保护
- AUX 空闲静态电流：240  $\mu\text{A}$
- AUX 待机静态电流：50  $\mu\text{A}$
- BST 空闲静态电流：60  $\mu\text{A}$
- 最大电源和输入逻辑引脚电压：26V
- 具有双散热焊盘的 9mm x 7mm QFN 封装

### 2 应用

- 有源钳位反激式电源转换器
- 交流/直流适配器和充电器
- 交流/直流 USB 墙壁插座电源
- 交流/直流辅助电源

### 3 说明

LMG2610 是一款 650V GaN 功率 FET 半桥，适用于开关模式电源应用中  $< 75\text{W}$  的有源钳位反激式 (ACF) 转换器。LMG2610 通过在 9mm x 7mm QFN 封装中集成半桥功率 FET、栅极驱动器、自举二极管和高侧栅极驱动电平转换器，简化了设计、减少了元件数量并减小了电路板空间。

非对称 GaN FET 电阻针对 ACF 工作条件进行了优化。可编程导通压摆率可提供 EMI 和振铃控制。与传统的电流检测电阻相比，低侧电流检测仿真可降低功耗，并允许将低侧散热焊盘连接到冷却 PCB 电源接地。

高侧栅极驱动信号电平转换器消除了外部解决方案中出现的噪声和突发模式功率耗散问题。智能开关 GaN 自举 FET 没有二极管正向压降，可避免高侧电源过充，并且反向恢复电荷为零。

LMG2610 具有低静态电流和快速启动时间，支持转换器轻负载效率要求和突发模式运行。保护特性包括 FET 导通互锁、欠压锁定 (UVLO)、逐周期电流限制和过热关断。

#### 器件信息

| 器件型号    | 封装 <sup>(1)</sup> | 封装尺寸 (标称值)        |
|---------|-------------------|-------------------|
| LMG2610 | QFN               | 9.00 mm x 7.00 mm |

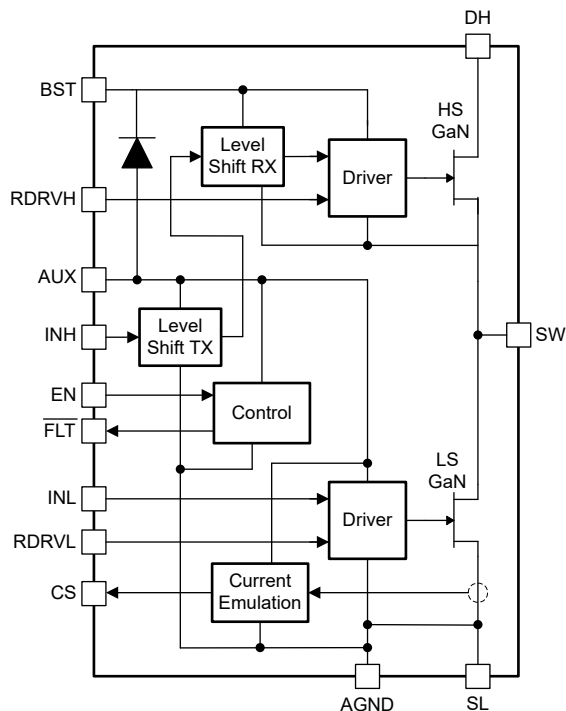

简化版方框图

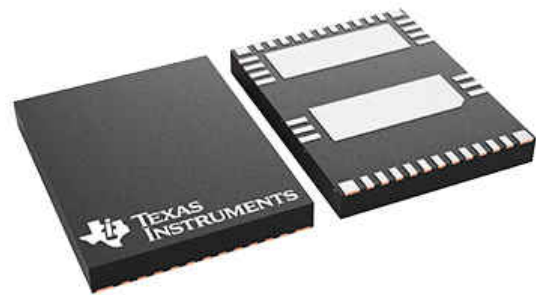

## Table of Contents

|                                                  |           |                                                                  |           |
|--------------------------------------------------|-----------|------------------------------------------------------------------|-----------|
| <b>1 特性</b> .....                                | <b>1</b>  | 8.2 Functional Block Diagram.....                                | <b>20</b> |
| <b>2 应用</b> .....                                | <b>1</b>  | 8.3 Feature Description.....                                     | <b>21</b> |
| <b>3 说明</b> .....                                | <b>1</b>  | 8.4 Device Functional Modes.....                                 | <b>28</b> |
| <b>4 Revision History</b> .....                  | <b>2</b>  | <b>9 Application and Implementation</b> .....                    | <b>29</b> |
| <b>5 Pin Configuration and Functions</b> .....   | <b>3</b>  | 9.1 Application Information.....                                 | <b>29</b> |
| <b>6 Specifications</b> .....                    | <b>5</b>  | 9.2 Typical Application.....                                     | <b>30</b> |
| 6.1 Absolute Maximum Ratings.....                | <b>5</b>  | 9.3 Power Supply Recommendations.....                            | <b>32</b> |
| 6.2 ESD Ratings.....                             | <b>5</b>  | 9.4 Layout.....                                                  | <b>33</b> |
| 6.3 Recommended Operating Conditions.....        | <b>6</b>  | <b>10 Device and Documentation Support</b> .....                 | <b>36</b> |
| 6.4 Thermal Information.....                     | <b>6</b>  | 10.1 Documentation Support.....                                  | <b>36</b> |
| 6.5 Electrical Characteristics.....              | <b>7</b>  | 10.2 接收文档更新通知.....                                               | <b>36</b> |
| 6.6 Switching Characteristics.....               | <b>10</b> | 10.3 支持资源.....                                                   | <b>36</b> |
| 6.7 Typical Characteristics.....                 | <b>12</b> | 10.4 Trademarks.....                                             | <b>36</b> |
| <b>7 Parameter Measurement Information</b> ..... | <b>17</b> | 10.5 Electrostatic Discharge Caution.....                        | <b>36</b> |
| 7.1 GaN Power FET Switching Parameters.....      | <b>17</b> | 10.6 术语表.....                                                    | <b>36</b> |
| <b>8 Detailed Description</b> .....              | <b>19</b> | <b>11 Mechanical, Packaging, and Orderable Information</b> ..... | <b>37</b> |
| 8.1 Overview.....                                | <b>19</b> |                                                                  |           |

## 4 Revision History

注：以前版本的页码可能与当前版本的页码不同

| <b>Changes from Revision * (October 2022) to Revision A (December 2022)</b> | <b>Page</b> |
|-----------------------------------------------------------------------------|-------------|
| • 将数据表状态从“预告信息”更改为“量产数据” .....                                              | <b>1</b>    |

### 5 Pin Configuration and Functions



图 5-1. RRG Package, 40-Pin VQFN (Top View)

表 5-1. Pin Functions

| PIN    |              | TYPE <sup>(1)</sup> | DESCRIPTION                                                                                                                                                                                                                                                                                                                                                  |
|--------|--------------|---------------------|--------------------------------------------------------------------------------------------------------------------------------------------------------------------------------------------------------------------------------------------------------------------------------------------------------------------------------------------------------------|
| NAME   | NO.          |                     |                                                                                                                                                                                                                                                                                                                                                              |
| NC1    | 1, 13        | NC                  | Used to anchor QFN package to PCB. Pins must be soldered to PCB landing pads. The PCB landing pads are non-solder mask defined pads and must not be physically connected to any other metal on the PCB. Internally connected to DH.                                                                                                                          |
| DH     | 2-12         | P                   | High-side GaN FET drain. Internally connected to NC1.                                                                                                                                                                                                                                                                                                        |
| SW     | 14-16        | P                   | GaN FET half-bridge switch node between the high-side GaN FET source and low-side GaN FET drain. Internally connected to PADH.                                                                                                                                                                                                                               |
| NC2    | 17, 21, 37   | NC                  | Used to anchor QFN package to PCB. Pins must be soldered to PCB landing pads. The PCB landing pads are non-solder mask defined pads and must not be physically connected to any other metal on the PCB. Internally connected to AGND, SL, and PADL.                                                                                                          |
| SL     | 18-20, 22-27 | P                   | Low-side GaN FET source. Internally connected to AGND, PADL, and NC2.                                                                                                                                                                                                                                                                                        |
| EN     | 28           | I                   | Enable. Used to toggle between active and standby modes. The standby mode has reduced quiescent current to support converter light load efficiency targets. There is a forward biased ESD diode from EN to AUX so avoid driving EN higher than AUX.                                                                                                          |
| INH    | 29           | I                   | High-side gate-drive control input. Referenced to AGND. Signal is level shifted internally to the high-side GaN FET driver. There is a forward biased ESD diode from INH to AUX so avoid driving INH higher than AUX.                                                                                                                                        |
| INL    | 30           | I                   | Low-side gate-drive control input. Referenced to AGND. There is a forward biased ESD diode from INL to AUX so avoid driving INL higher than AUX.                                                                                                                                                                                                             |
| AGND   | 31           | GND                 | Low-side analog ground. Internally connected to SL, PADL, and NC2.                                                                                                                                                                                                                                                                                           |
| CS     | 32           | O                   | Current-sense emulation output. Outputs 1 ma/A scaled replica of the low-side GaN FET current. Feed output current into a resistor to create a current sense voltage signal. Reference the resistor to the power supply controller IC local ground. This function replaces the external current-sense resistor that is used in series with the low-side FET. |
| NC3    | 33           | NC                  | Used to anchor QFN package to PCB. Pin must be soldered to a PCB landing pad. The PCB landing pad is non-solder mask defined pad and must not be physically connected to any other metal on the PCB. Pin not connected internally.                                                                                                                           |
| FLT    | 34           | O                   | Active-low fault output. Open-drain output that asserts during an over-temperature shut down.                                                                                                                                                                                                                                                                |
| AUX    | 35           | P                   | Auxiliary voltage rail. Low-side supply voltage. Connect a local bypass capacitor between AUX and AGND.                                                                                                                                                                                                                                                      |
| RDRV L | 36           | I                   | Low-side drive strength control resistor. Set a resistance between RDRV L and AGND to program the low-side GaN FET turn-on slew rate.                                                                                                                                                                                                                        |
| BST    | 38           | P                   | Bootstrap voltage rail. High-side supply voltage. The bootstrap diode function between AUX and BST is internally provided. Connect an appropriately sized bootstrap capacitor between BST and SW. Recommend to make the SW connection using NC4 as a pass through connection to PADH (PADH = SW) as explained in the NC4 description.                        |
| RDRV H | 39           | I                   | High-side drive strength control resistor. Set a resistance between RDRV H and SW to program the high-side GaN FET turn-on slew rate. Recommend to make the SW connection using NC4 as a pass through connection to PADH (PADH = SW) as explained in the NC4 description.                                                                                    |
| NC4    | 40           | NC                  | Pin is not functional. Pin is high impedance and referenced to SW. Recommend to connect pin to PADH (PADH = SW) to use as convenient connection for the BST bypass capacitor and the RDRV H resistor. See the example board layout in the <a href="#">Layout Example</a> section.                                                                            |
| PADH   | 41           | TP                  | High-side thermal pad. Internally connected to SW. All the SW current can be conducted with PADH (PADH = SW).                                                                                                                                                                                                                                                |
| PADL   | 42           | TP                  | Low-side thermal pad. Internally connected to SL, AGND, and NC2. All the SL current can be conducted with PADL (PADL = SL).                                                                                                                                                                                                                                  |

(1) I = Input, O = Output, G = Ground, P = Power, NC = No Connect, TP = Thermal Pad.

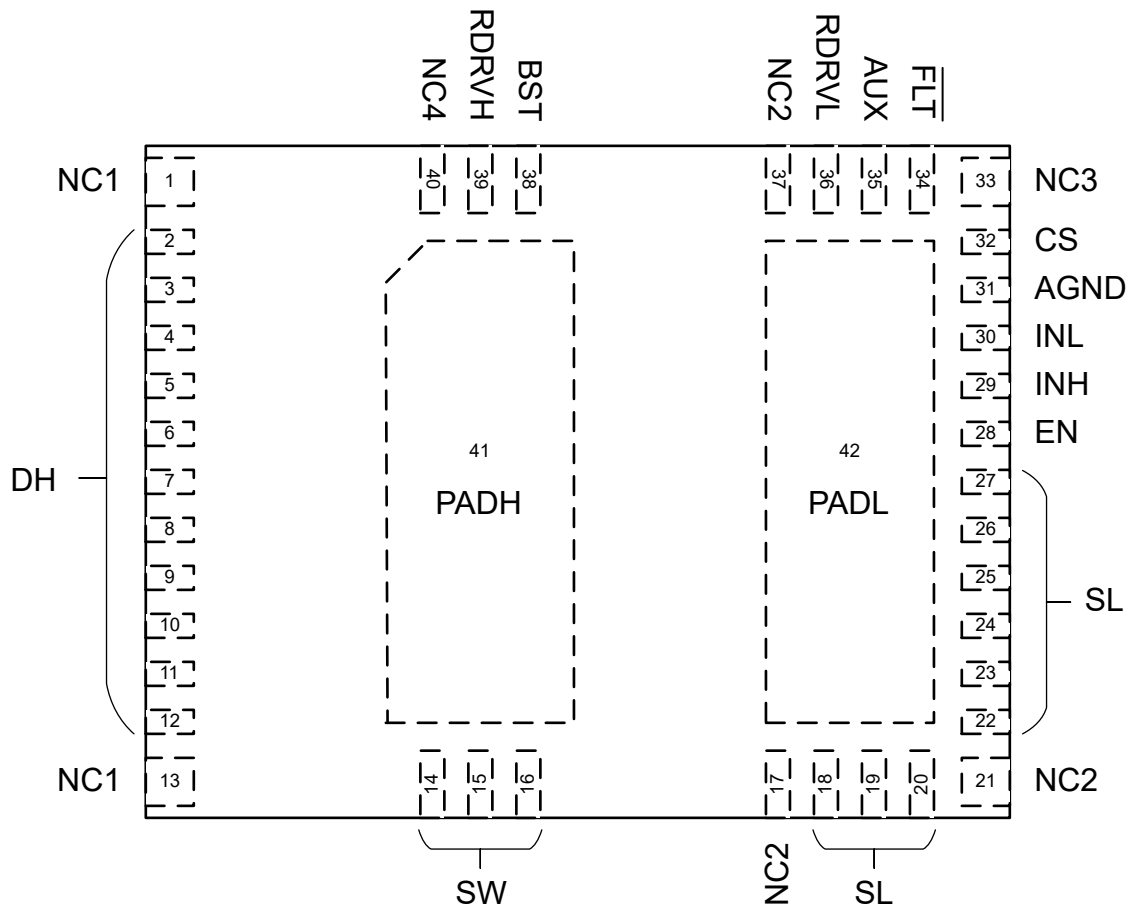
## 6 Specifications

### 6.1 Absolute Maximum Ratings

Unless otherwise noted: voltages are respect to AGND<sup>(1)</sup>

|                         |                                                                                                           | MIN                  | MAX                | UNIT               |    |
|-------------------------|-----------------------------------------------------------------------------------------------------------|----------------------|--------------------|--------------------|----|
| $V_{DS(ls)}$            | Low-side drain-source (SW to SL) voltage, FET off                                                         |                      | 650                | V                  |    |
| $V_{DS(surge)(ls)}$     | Low-side drain-source (SW to SL) voltage, surge condition, FET off <sup>(2)</sup>                         |                      | 720                | V                  |    |
| $V_{DS(tr)(surge)(ls)}$ | Low-side drain-source (SW to SL) transient ringing peak voltage, surge condition, FET off <sup>(2)</sup>  |                      | 800                | V                  |    |
| $V_{DS(hs)}$            | High-side drain source (DH to SW) voltage, FET off                                                        |                      | 650                | V                  |    |
| $V_{DS(surge)(hs)}$     | High-side drain-source (DH to SW) voltage, surge condition, FET off <sup>(2)</sup>                        |                      | 720                | V                  |    |
| $V_{DS(tr)(surge)(hs)}$ | High-side drain-source (DH to SW) transient ringing peak voltage, surge condition, FET off <sup>(2)</sup> |                      | 800                | V                  |    |
|                         | Pin voltage                                                                                               | AUX                  | - 0.3              | 30                 | V  |
|                         |                                                                                                           | EN, INL, INH, FLT    | - 0.3              | $V_{AUX} + 0.3$    | V  |
|                         |                                                                                                           | CS                   | - 0.3              | 5.5                | V  |
|                         |                                                                                                           | RDRV L               | - 0.3              | 4                  | V  |
|                         | Pin voltage to SW                                                                                         | BST                  | - 0.3              | 30                 | V  |
|                         |                                                                                                           | RDRV H               | - 0.3              | 4                  | V  |
| $I_{D(peak)(ls)}$       | Low-side drain (SW to SL) peak current, FET on                                                            | - 6.4                | Internally limited | A                  |    |
| $I_{S(peak)(ls)}$       | Low-side source (SL to SW) peak current, FET off                                                          |                      | 6.4                | A                  |    |
| $I_{D(peak)(hs)}$       | High-side drain (DH to SW) peak current, FET on                                                           | - 4                  | Internally limited | A                  |    |
| $I_{S(peak)(hs)}$       | High-side source (SW to DH) peak current, FET off                                                         |                      | 4                  | A                  |    |
|                         | Positive sink current                                                                                     | CS                   |                    | 10                 | mA |
|                         |                                                                                                           | FLT (while asserted) |                    | Internally limited | mA |
| $T_J$                   | Operating junction temperature                                                                            | - 40                 | 150                | °C                 |    |
| $T_{stg}$               | Storage temperature                                                                                       | - 65                 | 150                | °C                 |    |

- (1) Operation outside the Absolute Maximum Ratings may cause permanent device damage. Absolute Maximum Ratings do not imply functional operation of the device at these or any other conditions beyond those listed under Recommended Operating Conditions. If used outside the Recommended Operating Conditions but within the Absolute Maximum Ratings, the device may not be fully functional, and this may affect device reliability, functionality, performance, and shorten the device lifetime.
- (2) See [GaN Power FET Switching Capability](#) for more information on the GaN FET switching capability.

### 6.2 ESD Ratings

|             |                         |                                                                       | VALUE | UNIT |
|-------------|-------------------------|-----------------------------------------------------------------------|-------|------|
| $V_{(ESD)}$ | Electrostatic discharge | Human body model (HBM), per ANSI/ESDA/JEDEC JS-001 <sup>(1)</sup>     | ±1000 | V    |
|             |                         |                                                                       | ±2000 | V    |
|             |                         | Charged device model (CDM), per ANSI/ESDA/JEDEC JS-002 <sup>(2)</sup> | ±500  | V    |

- (1) JEDEC document JEP155 states that 500-V HBM allows safe manufacturing with a standard ESD control process.
- (2) JEDEC document JEP157 states that 250-V CDM allows safe manufacturing with a standard ESD control process.

### 6.3 Recommended Operating Conditions

Unless otherwise noted: voltages are respect to AGND

|                          |                                                                                                                   |              | MIN                  | NOM | MAX              | UNIT |
|--------------------------|-------------------------------------------------------------------------------------------------------------------|--------------|----------------------|-----|------------------|------|
|                          | Supply voltage                                                                                                    | AUX          | 10                   |     | 26               | V    |
|                          | Supply voltage to SW                                                                                              | BST          | 7.5                  |     | 26               | V    |
|                          | Input voltage                                                                                                     | EN, INL, INH | 0                    |     | V <sub>AUX</sub> | V    |
|                          | Pull-up voltage on open-drain output                                                                              | FLT          | 0                    |     | V <sub>AUX</sub> | V    |
| V <sub>IH</sub>          | High-level input voltage                                                                                          | EN, INL, INH | 2.5                  |     |                  | V    |
| V <sub>IL</sub>          | Low-level input voltage                                                                                           |              |                      |     | 0.6              | V    |
| I <sub>D(peak)(ls)</sub> | Low-side drain (SW to SL) peak current, FET on                                                                    |              | - 3.2                |     | 5.4              | A    |
| I <sub>D(peak)(hs)</sub> | High-side drain (DH to SW) peak current, FET on                                                                   |              | - 2                  |     | 3                | A    |
| C <sub>AUX</sub>         | AUX to AGND capacitance from external bypass capacitor                                                            |              | 3 x C <sub>BST</sub> |     |                  | μF   |
| C <sub>BST_SW</sub>      | BST to SW capacitance from external bypass capacitor                                                              |              | 0.010                |     |                  | μF   |
| R <sub>RDRV_L</sub>      | RDRV_L to AGND resistance from external slew-rate control resistor to configure below low-side slew rate settings |              |                      |     |                  |      |
|                          | slew rate setting 0 (slowest)                                                                                     |              | 90                   | 120 | open             | kΩ   |
|                          | slew rate setting 1                                                                                               |              | 42.5                 | 47  | 51.5             | kΩ   |
|                          | slew rate setting 2                                                                                               |              | 20                   | 22  | 24               | kΩ   |
|                          | slew rate setting 3 (fastest)                                                                                     |              | 0                    | 5.6 | 11               | kΩ   |
| R <sub>RDRV_H_SW</sub>   | RDRV_H to SW resistance from external slew-rate control resistor to configure below high-side slew rate settings  |              |                      |     |                  |      |
|                          | slew rate setting 0 (slowest)                                                                                     |              | 90                   | 120 | open             | kΩ   |
|                          | slew rate setting 1                                                                                               |              | 42.5                 | 47  | 51.5             | kΩ   |
|                          | slew rate setting 2                                                                                               |              | 20                   | 22  | 24               | kΩ   |
|                          | slew rate setting 3 (fastest)                                                                                     |              | 0                    | 5.6 | 11               | kΩ   |

### 6.4 Thermal Information

| THERMAL METRIC <sup>(1)</sup> |                                              | LMG2610    | UNIT |
|-------------------------------|----------------------------------------------|------------|------|
|                               |                                              | RRG (VQFN) |      |
|                               |                                              | 40 Pins    |      |
| R <sub>θJA</sub>              | Junction-to-ambient thermal resistance       | 25.3       | °C/W |
| R <sub>θJC(bot)</sub>         | Junction-to-case (bottom) thermal resistance | 1.22       | °C/W |

- (1) For more information about traditional and new thermal metrics, see the [Semiconductor and IC Package Thermal Metrics](#) application report.

## 6.5 Electrical Characteristics

1) Symbol definitions:  $V_{DS(is)}$  = SW to SL voltage;  $I_{D(is)}$  = SW to SL current;  $V_{DS(hs)}$  = DH to SW voltage;  $I_{D(hs)}$  = DH to SW current; 2) Unless otherwise noted: voltage, resistance, and capacitance are respect to AGND;  $-40\text{ }^{\circ}\text{C} \leq T_J \leq 125\text{ }^{\circ}\text{C}$ ;  $10 \leq V_{AUX} \leq 26$ ;  $7.5 \leq V_{BST\_SW} \leq 26$ ;  $V_{EN} = 5\text{ V}$ ;  $V_{INL} = 0\text{ V}$ ;  $V_{INH} = 0\text{ V}$ ;  $R_{RDRVL} = 0\text{ }\Omega$ ;  $R_{RDRVH\_SW} = 0\text{ }\Omega$ ;  $R_{CS} = 100\text{ }\Omega$

| PARAMETER                               |                                                        | TEST CONDITIONS                                                                               | MIN | TYP   | MAX | UNIT          |
|-----------------------------------------|--------------------------------------------------------|-----------------------------------------------------------------------------------------------|-----|-------|-----|---------------|
| <b>LOW-SIDE GAN POWER FET</b>           |                                                        |                                                                                               |     |       |     |               |
| $R_{DS(on)(ls)}$                        | Drain-source (SW to SL) on resistance                  | $V_{INL} = 5\text{ V}$ , $I_{D(is)} = 3\text{ A}$ , $T_J = 25\text{ }^{\circ}\text{C}$        |     | 170   |     | m $\Omega$    |
|                                         |                                                        | $V_{INL} = 5\text{ V}$ , $I_{D(is)} = 3\text{ A}$ , $T_J = 125\text{ }^{\circ}\text{C}$       |     | 325   |     |               |
| $V_{SD(is)}$                            | Source-drain (SL to SW) third-quadrant voltage         | SL to SW current = 0.1 A                                                                      |     | -1.9  |     | V             |
|                                         |                                                        | SL to SW current = 1 A                                                                        |     | -2.6  |     |               |
| $I_{DSS(is)}$                           | Drain (SW to SL) leakage current                       | $V_{DS(hs)} = 0\text{ V}$ , $V_{DS(is)} = 650\text{ V}$ , $T_J = 25\text{ }^{\circ}\text{C}$  |     | 2     |     | $\mu\text{A}$ |
|                                         |                                                        | $V_{DS(hs)} = 0\text{ V}$ , $V_{DS(is)} = 650\text{ V}$ , $T_J = 125\text{ }^{\circ}\text{C}$ |     | 10    |     |               |
| $Q_{OSS(is)}$                           | Output (SW to SL) charge                               |                                                                                               |     | 19.7  |     | nC            |
| $C_{OSS(is)}$                           | Output (SW to SL) capacitance                          |                                                                                               |     | 22    |     | pF            |
| $E_{OSS(is)}$                           | Output (SW to SL) capacitance stored energy            | $V_{DS(hs)} = 0\text{ V}$ , $V_{DS(is)} = 400\text{ V}$                                       |     | 2.32  |     | $\mu\text{J}$ |
| $C_{OSS,er(is)}$                        | Energy related effective output (SW to SL) capacitance |                                                                                               |     | 29    |     | pF            |
| $C_{OSS,tr(is)}$                        | Time related effective output (SW to SL) capacitance   | $V_{DS(hs)} = 0\text{ V}$ , $V_{DS(is)} = 0\text{ V to }400\text{ V}$                         |     | 49.2  |     | pF            |
| $Q_{RR(is)}$                            | Reverse recovery charge                                |                                                                                               |     | 0     |     | nC            |
| <b>HIGH-SIDE GAN POWER FET</b>          |                                                        |                                                                                               |     |       |     |               |
| $R_{DS(on)(hs)}$                        | Drain-source (DH to SW) on resistance                  | $V_{INH} = 5\text{ V}$ , $I_{D(hs)} = 1.75\text{ A}$ , $T_J = 25\text{ }^{\circ}\text{C}$     |     | 248   |     | m $\Omega$    |
|                                         |                                                        | $V_{INH} = 5\text{ V}$ , $I_{D(hs)} = 1.75\text{ A}$ , $T_J = 125\text{ }^{\circ}\text{C}$    |     | 470   |     |               |
| $V_{SD(hs)}$                            | Source-drain (SW to DH) third-quadrant voltage         | SW to DH current = 0.1 A                                                                      |     | -2    |     | V             |
|                                         |                                                        | SW to DH current = 1 A                                                                        |     | -2.7  |     |               |
| $I_{DSS(hs)}$                           | Drain (DH to SW) leakage current                       | $V_{DS(is)} = 0\text{ V}$ , $V_{DS(hs)} = 650\text{ V}$ , $T_J = 25\text{ }^{\circ}\text{C}$  |     | 1.4   |     | $\mu\text{A}$ |
|                                         |                                                        | $V_{DS(is)} = 0\text{ V}$ , $V_{DS(hs)} = 650\text{ V}$ , $T_J = 125\text{ }^{\circ}\text{C}$ |     | 7     |     |               |
| $Q_{OSS(hs)}$                           | Output (DH to SW) charge                               |                                                                                               |     | 15.51 |     | nC            |
| $C_{OSS(hs)}$                           | Output (DH to SW) capacitance                          |                                                                                               |     | 22.4  |     | pF            |
| $E_{OSS(hs)}$                           | Output (DH to SW) capacitance stored energy            | $V_{DS(is)} = 0\text{ V}$ , $V_{DS(hs)} = 400\text{ V}$                                       |     | 2.15  |     | $\mu\text{J}$ |
| $C_{OSS,er(hs)}$                        | Energy related effective output (DH to SW) capacitance |                                                                                               |     | 26.9  |     | pF            |
| $C_{OSS,tr(hs)}$                        | Time related effective output (DH to SW) capacitance   | $V_{DS(is)} = 0\text{ V}$ , $V_{DS(hs)} = 0\text{ V to }400\text{ V}$                         |     | 38.78 |     | pF            |
| $Q_{RR(hs)}$                            | Reverse recovery charge                                |                                                                                               |     | 0     |     | nC            |
| <b>LOW-SIDE OVERCURRENT PROTECTION</b>  |                                                        |                                                                                               |     |       |     |               |
| $I_{T(OC)(ls)}$                         | Overcurrent fault - threshold current                  |                                                                                               | 5.4 | 5.9   | 6.4 | A             |
| <b>HIGH-SIDE OVERCURRENT PROTECTION</b> |                                                        |                                                                                               |     |       |     |               |
| $I_{T(OC)(hs)}$                         | Overcurrent fault - threshold current                  |                                                                                               | 3   | 3.5   | 4   | A             |
| <b>BOOTSTRAP RECTIFIER</b>              |                                                        |                                                                                               |     |       |     |               |
| $R_{DS(on)}$                            | AUX to BST on resistance                               | $V_{INL} = 5\text{ V}$ , $V_{AUX\_BST} = 1\text{ V}$ , $T_J = 25\text{ }^{\circ}\text{C}$     |     | 8     |     | $\Omega$      |
|                                         |                                                        | $V_{INL} = 5\text{ V}$ , $V_{AUX\_BST} = 1\text{ V}$ , $T_J = 125\text{ }^{\circ}\text{C}$    |     | 14    |     |               |
|                                         | AUX to BST current limit                               | $V_{INL} = 5\text{ V}$ , $V_{AUX\_BST} = 7\text{ V}$                                          | 210 | 240   | 270 | mA            |
|                                         | BST to AUX reverse current blocking threshold          | $V_{INL} = 5\text{ V}$                                                                        |     | 15    |     | mA            |

**LMG2610**

ZHCSNW8A - OCTOBER 2022 - REVISED DECEMBER 2022

1) Symbol definitions:  $V_{DS(is)}$  = SW to SL voltage;  $I_{D(is)}$  = SW to SL current;  $V_{DS(hs)}$  = DH to SW voltage;  $I_{D(hs)}$  = DH to SW current; 2) Unless otherwise noted: voltage, resistance, and capacitance are respect to AGND;  $-40\text{ }^{\circ}\text{C} \leq T_J \leq 125\text{ }^{\circ}\text{C}$ ;  $10 \leq V_{AUX} \leq 26$ ;  $7.5 \leq V_{BST\_SW} \leq 26$ ;  $V_{EN} = 5\text{ V}$ ;  $V_{INL} = 0\text{ V}$ ;  $V_{INH} = 0\text{ V}$ ;  $R_{RDRVL} = 0\text{ }\Omega$ ;  $R_{RDRVH\_SW} = 0\text{ }\Omega$ ;  $R_{CS} = 100\text{ }\Omega$

| PARAMETER                          |                                                                           | TEST CONDITIONS                                                                                                            | MIN  | TYP  | MAX  | UNIT               |
|------------------------------------|---------------------------------------------------------------------------|----------------------------------------------------------------------------------------------------------------------------|------|------|------|--------------------|
| <b>CS</b>                          |                                                                           |                                                                                                                            |      |      |      |                    |
|                                    | Current sense gain ( $I_{CS(src)} / I_{D(LS)}$ )                          | $V_{INL} = 5\text{ V}$ , $0\text{ A} \leq I_{D(is)} < I_{T(OC)(is)}$ , $0\text{ V} \leq V_{CS} \leq 2\text{ V}$            |      | 1    |      | mA/A               |
|                                    | Current sense input offset current                                        | $V_{INL} = 5\text{ V}$ , $0\text{ A} \leq I_{D(is)} < I_{T(OC)(is)}$ , $0\text{ V} \leq V_{CS} \leq 2\text{ V}$            | - 50 |      | 50   | mA                 |
|                                    | Initial held output after overcurrent fault occurs while INL remains high | $V_{INL} = 5\text{ V}$ , $0\text{ V} \leq V_{CS} \leq 2\text{ V}$                                                          |      |      | 7    | mA                 |
| $I_{CS(src)}$<br>(OC)(final)       | Final held output after overcurrent fault occurs while INL remains high   | $V_{INL} = 5\text{ V}$ , $0\text{ V} \leq V_{CS} \leq 2\text{ V}$                                                          | 10   | 12   | 15.5 | mA                 |
|                                    | Output clamp voltage                                                      | $V_{INL} = 5\text{ V}$ , $I_{D(is)} = 5\text{ A}$ , CS sinking 5 mA from external source                                   |      | 2.5  |      | V                  |
| <b>EN, INL, INH</b>                |                                                                           |                                                                                                                            |      |      |      |                    |
| $V_{IT+}$                          | Positive-going input threshold voltage                                    |                                                                                                                            | 1.7  |      | 2.45 | V                  |
| $V_{IT-}$                          | Negative-going input threshold voltage                                    |                                                                                                                            | 0.7  |      | 1.3  | V                  |
|                                    | Input threshold voltage hysteresis                                        |                                                                                                                            |      | 1    |      | V                  |
|                                    | Pull-down resistance                                                      | $0\text{ V} \leq V_{PIN} \leq 3\text{ V}$                                                                                  | 200  | 400  | 600  | k $\Omega$         |
|                                    | Pull-down current                                                         | $V_{AUX} = 26\text{ V}$ ; $10\text{ V} \leq V_{PIN} \leq 26\text{ V}$                                                      |      | 10   |      | $\mu\text{A}$      |
| <b>OVER-TEMPERATURE PROTECTION</b> |                                                                           |                                                                                                                            |      |      |      |                    |
|                                    | Temperature fault - positive-going threshold temperature                  |                                                                                                                            |      | 150  |      | $^{\circ}\text{C}$ |
|                                    | Temperature fault - negative-going threshold temperature                  |                                                                                                                            |      | 130  |      | $^{\circ}\text{C}$ |
|                                    | Temperature fault - threshold temperature hysteresis                      |                                                                                                                            |      | 20   |      | $^{\circ}\text{C}$ |
| <b>FLT</b>                         |                                                                           |                                                                                                                            |      |      |      |                    |
|                                    | Low-level output voltage                                                  | FLT sinking 1mA while asserted                                                                                             |      |      | 200  | mV                 |
|                                    | Off-state current                                                         | $V_{FLT} = V_{AUX}$ while de-asserted                                                                                      |      |      | 1    | $\mu\text{A}$      |
| <b>AUX</b>                         |                                                                           |                                                                                                                            |      |      |      |                    |
| $V_{AUX,T+}$<br>(UVLO)             | UVLO - positive-going threshold voltage                                   |                                                                                                                            | 8.9  | 9.3  | 9.7  | V                  |
|                                    | UVLO - negative-going threshold voltage                                   |                                                                                                                            | 8.6  | 9.0  | 9.4  | V                  |
|                                    | UVLO - threshold voltage hysteresis                                       |                                                                                                                            |      | 250  |      | mV                 |
|                                    | Standby quiescent current                                                 | $V_{EN} = 0\text{ V}$                                                                                                      |      | 50   | 80   | $\mu\text{A}$      |
|                                    | Quiescent current                                                         |                                                                                                                            |      | 250  | 370  | $\mu\text{A}$      |
|                                    | Quiescent current                                                         | $V_{INL} = 5\text{ V}$ , $I_{D(is)} = 0\text{ A}$                                                                          |      | 1370 |      | $\mu\text{A}$      |
|                                    | Operating current                                                         | $V_{INL} = 0\text{ V}$ or $5\text{ V}$ , $V_{DS(is)} = 0\text{ V}$ , $f_{INL} = 500\text{ kHz}$ , $I_{D(is)} = 0\text{ A}$ |      | 3.1  |      | mA                 |
| <b>BST</b>                         |                                                                           |                                                                                                                            |      |      |      |                    |
| $V_{BST\_SW,T+}$<br>(UVLO)         | $V_{BST\_SW}$ UVLO for FET to turn on - positive-going threshold voltage  |                                                                                                                            | 6.7  | 7    | 7.3  | V                  |
|                                    | $V_{BST\_SW}$ UVLO for FET to stay on - negative-going threshold voltage  |                                                                                                                            | 4.8  | 5.1  | 5.4  | V                  |
|                                    | Quiescent current                                                         |                                                                                                                            |      | 65   | 100  | $\mu\text{A}$      |
|                                    | Quiescent current                                                         | $V_{INH} = 5\text{ V}$                                                                                                     |      | 330  |      | $\mu\text{A}$      |



1) Symbol definitions:  $V_{DS(is)}$  = SW to SL voltage;  $I_{DS(is)}$  = SW to SL current;  $V_{DS(hs)}$  = DH to SW voltage;  $I_{D(hs)}$  = DH to SW current; 2) Unless otherwise noted: voltage, resistance, and capacitance are respect to AGND;  $-40\text{ }^{\circ}\text{C} \leq T_J \leq 125\text{ }^{\circ}\text{C}$ ;  $10 \leq V_{AUX} \leq 26$ ;  $7.5 \leq V_{BST\_SW} \leq 26$ ;  $V_{EN} = 5\text{ V}$ ;  $V_{INL} = 0\text{ V}$ ;  $V_{INH} = 0\text{ V}$ ;  $R_{RDRV L} = 0\text{ }\Omega$ ;  $R_{RDRV H\_SW} = 0\text{ }\Omega$ ;  $R_{CS} = 100\text{ }\Omega$

| PARAMETER |                   | TEST CONDITIONS                                                                               | MIN | TYP | MAX | UNIT |
|-----------|-------------------|-----------------------------------------------------------------------------------------------|-----|-----|-----|------|
|           | Operating current | $V_{INH} = 0\text{ V or }5\text{ V}$ , $V_{DS(hs)} = 0\text{ V}$ ; $f_{INH} = 500\text{ kHz}$ |     | 1.2 |     | mA   |

## 6.6 Switching Characteristics

1) Symbol definitions:  $V_{DS(is)}$  = SW to SL voltage;  $I_{D(is)}$  = SW to SL current;  $V_{DS(hs)}$  = DH to SW voltage;  $I_{D(hs)}$  = DH to SW current; 2) Unless otherwise noted: voltage, resistance, and capacitance are respect to AGND;  $-40\text{ }^{\circ}\text{C} \leq T_J \leq 125\text{ }^{\circ}\text{C}$ ;  $10 \leq V_{AUX} \leq 26$ ;  $7.5 \leq V_{BST\ SW} \leq 26$ ;  $V_{EN} = 5\text{ V}$ ;  $V_{INL} = 0\text{ V}$ ;  $V_{INH} = 0\text{ V}$ ;  $R_{RDRVL} = 0\text{ }\Omega$ ;  $R_{RDRVH\ SW} = 0\text{ }\Omega$ ;  $R_{CS} = 100\text{ }\Omega$

| PARAMETER                          | TEST CONDITIONS                  | MIN                                                                                                                                                                                                                                                            | TYP | MAX  | UNIT |
|------------------------------------|----------------------------------|----------------------------------------------------------------------------------------------------------------------------------------------------------------------------------------------------------------------------------------------------------------|-----|------|------|
| <b>LOW-SIDE GAN POWER FET</b>      |                                  |                                                                                                                                                                                                                                                                |     |      |      |
| $t_{d(on)}$<br>( $I_{drain}(is)$ ) | Drain current turn-on delay time | From $V_{INL} > V_{INL,IT+}$ to $I_{D(is)} > 50\text{ mA}$ ,<br>$V_{BUS} = 400\text{ V}$ , $L_{HB}$ current = 2 A, at below<br>low-side slew rate settings, see <a href="#">GaN<br/>Power FET Switching Parameters</a>                                         |     |      |      |
|                                    |                                  | slew rate setting 0 (slowest)                                                                                                                                                                                                                                  |     | 68   | ns   |
|                                    |                                  | slew rate setting 1                                                                                                                                                                                                                                            |     | 40   |      |
|                                    |                                  | slew rate setting 2                                                                                                                                                                                                                                            |     | 35   |      |
| slew rate setting 3 (fastest)      |                                  | 34                                                                                                                                                                                                                                                             |     |      |      |
| $t_{d(on)(is)}$                    | Turn-on delay time               | From $V_{INL} > V_{INL,IT+}$ to $V_{DS(is)} < 320\text{ V}$ ,<br>$V_{BUS} = 400\text{ V}$ , $L_{HB}$ current = 2 A, at below<br>low-side slew rate settings, see <a href="#">GaN<br/>Power FET Switching Parameters</a>                                        |     |      |      |
|                                    |                                  | slew rate setting 0 (slowest)                                                                                                                                                                                                                                  |     | 91   | ns   |
|                                    |                                  | slew rate setting 1                                                                                                                                                                                                                                            |     | 50   |      |
|                                    |                                  | slew rate setting 2                                                                                                                                                                                                                                            |     | 43   |      |
| slew rate setting 3 (fastest)      |                                  | 37                                                                                                                                                                                                                                                             |     |      |      |
| $t_{r(on)(is)}$                    | Turn-on rise time                | From $V_{DS(is)} < 320\text{ V}$ to $V_{DS(is)} < 80\text{ V}$ ,<br>$V_{BUS} = 400\text{ V}$ , $L_{HB}$ current = 2 A, at below<br>low-side slew rate settings, see <a href="#">GaN<br/>Power FET Switching Parameters</a>                                     |     |      |      |
|                                    |                                  | slew rate setting 0 (slowest)                                                                                                                                                                                                                                  |     | 14.9 | ns   |
|                                    |                                  | slew rate setting 1                                                                                                                                                                                                                                            |     | 5.6  |      |
|                                    |                                  | slew rate setting 2                                                                                                                                                                                                                                            |     | 3.8  |      |
| slew rate setting 3 (fastest)      |                                  | 1.9                                                                                                                                                                                                                                                            |     |      |      |
| $t_{d(off)(is)}$                   | Turn-off delay time              | From $V_{INL} < V_{INL,IT-}$ to $V_{DS(is)} > 80\text{ V}$ ,<br>$V_{BUS} = 400\text{ V}$ , $L_{HB}$ current = 2 A,<br>(independent of slew rate<br>setting), see <a href="#">GaN Power FET Switching<br/>Parameters</a>                                        |     | 43   | ns   |
| $t_{f(off)(is)}$                   | Turn-off fall time               | From $V_{DS(is)} > 80\text{ V}$ to $V_{DS(is)} > 320\text{ V}$ ,<br>$V_{BUS} = 400\text{ V}$ , $L_{HB}$ current = 2 A,<br>(independent of slew rate<br>setting), see <a href="#">GaN Power FET Switching<br/>Parameters</a>                                    |     | 12.5 | ns   |
| Turn-on slew rate                  |                                  | From $V_{DS(is)} < 250\text{ V}$ to $V_{DS(is)} < 150\text{ V}$ , $T_J$<br>= 25 $^{\circ}\text{C}$ , $V_{BUS} = 400\text{ V}$ , $L_{HB}$ current = 2 A,<br>at below low-side slew rate<br>settings, see <a href="#">GaN Power FET Switching<br/>Parameters</a> |     |      |      |
|                                    |                                  | slew rate setting 0 (slowest)                                                                                                                                                                                                                                  |     | 20   | V/ns |
|                                    |                                  | slew rate setting 1                                                                                                                                                                                                                                            |     | 50   |      |
|                                    |                                  | slew rate setting 2                                                                                                                                                                                                                                            |     | 70   |      |
| slew rate setting 3 (fastest)      |                                  | 140                                                                                                                                                                                                                                                            |     |      |      |

1) Symbol definitions:  $V_{DS(is)}$  = SW to SL voltage;  $I_{D(is)}$  = SW to SL current;  $V_{DS(hs)}$  = DH to SW voltage;  $I_{D(hs)}$  = DH to SW current; 2) Unless otherwise noted: voltage, resistance, and capacitance are respect to AGND;  $-40\text{ }^{\circ}\text{C} \leq T_J \leq 125\text{ }^{\circ}\text{C}$ ;  $10 \leq V_{AUX} \leq 26$ ;  $7.5 \leq V_{BST\ SW} \leq 26$ ;  $V_{EN} = 5\text{ V}$ ;  $V_{INL} = 0\text{ V}$ ;  $V_{INH} = 0\text{ V}$ ;  $R_{RDRVL} = 0\text{ }\Omega$ ;  $R_{RDRVH\ SW} = 0\text{ }\Omega$ ;  $R_{CS} = 100\text{ }\Omega$

| PARAMETER                          |                                  | TEST CONDITIONS                                                                                                                                                                                                                                                      | MIN | TYP  | MAX | UNIT |
|------------------------------------|----------------------------------|----------------------------------------------------------------------------------------------------------------------------------------------------------------------------------------------------------------------------------------------------------------------|-----|------|-----|------|
| <b>HIGH-SIDE GAN POWER FET</b>     |                                  |                                                                                                                                                                                                                                                                      |     |      |     |      |
| $t_{d(on)}$<br>( $I_{drain}$ )(hs) | Drain current turn-on delay time | From $V_{INH} > V_{INH,IT+}$ to $I_{D(hs)} > 50\text{ mA}$ ,<br>$V_{BUS} = 400\text{ V}$ , $L_{HB}$ current = 2 A, at below<br>high-side slew rate settings, see <a href="#">GaN<br/>Power FET Switching Parameters</a>                                              |     |      |     |      |
|                                    |                                  | slew rate setting 0 (slowest)                                                                                                                                                                                                                                        |     | 60   |     | ns   |
|                                    |                                  | slew rate setting 1                                                                                                                                                                                                                                                  |     | 34   |     |      |
|                                    |                                  | slew rate setting 2                                                                                                                                                                                                                                                  |     | 31   |     |      |
| slew rate setting 3 (fastest)      |                                  | 28                                                                                                                                                                                                                                                                   |     |      |     |      |
| $t_{d(on)}$ (hs)                   | Turn-on delay time               | From $V_{INH} > V_{INH,IT+}$ to $V_{DS(hs)} < 320\text{ V}$ ,<br>$V_{BUS} = 400\text{ V}$ , $L_{HB}$ current = 2 A, at below<br>high-side slew rate settings, see <a href="#">GaN<br/>Power FET Switching Parameters</a>                                             |     |      |     |      |
|                                    |                                  | slew rate setting 0 (slowest)                                                                                                                                                                                                                                        |     | 86   |     | ns   |
|                                    |                                  | slew rate setting 1                                                                                                                                                                                                                                                  |     | 46   |     |      |
|                                    |                                  | slew rate setting 2                                                                                                                                                                                                                                                  |     | 39   |     |      |
| slew rate setting 3 (fastest)      |                                  | 32                                                                                                                                                                                                                                                                   |     |      |     |      |
| $t_{r(on)}$ (hs)                   | Turn-on rise time                | From $V_{DS(hs)} < 320\text{ V}$ to $V_{DS(hs)} < 80\text{ V}$ ,<br>$V_{BUS} = 400\text{ V}$ , $L_{HB}$ current = 2 A, at below<br>high-side slew rate settings, see <a href="#">GaN<br/>Power FET Switching Parameters</a>                                          |     |      |     |      |
|                                    |                                  | slew rate setting 0 (slowest)                                                                                                                                                                                                                                        |     | 13.1 |     | ns   |
|                                    |                                  | slew rate setting 1                                                                                                                                                                                                                                                  |     | 4.7  |     |      |
|                                    |                                  | slew rate setting 2                                                                                                                                                                                                                                                  |     | 3.2  |     |      |
| slew rate setting 3 (fastest)      |                                  | 1.7                                                                                                                                                                                                                                                                  |     |      |     |      |
| $t_{d(off)}$ (hs)                  | Turn-off delay time              | From $V_{INH} < V_{INH,IT-}$ to $V_{DS(hs)} > 80\text{ V}$ ,<br>$V_{BUS} = 400\text{ V}$ , $L_{HB}$ current = 2 A,<br>(independent of slew rate<br>setting), see <a href="#">GaN Power FET Switching<br/>Parameters</a>                                              |     | 37   |     | ns   |
| $t_{f(off)}$ (hs)                  | Turn-off fall time               | From $V_{DS(hs)} > 80\text{ V}$ to $V_{DS(hs)} > 320\text{ V}$ ,<br>$V_{BUS} = 400\text{ V}$ , $L_{HB}$ current = 2 A,<br>(independent of slew rate<br>setting), see <a href="#">GaN Power FET Switching<br/>Parameters</a>                                          |     | 12.5 |     | ns   |
|                                    | Turn-on slew rate                | From $V_{DS(hs)} < 250\text{ V}$ to $V_{DS(hs)} < 150\text{ V}$ ,<br>$T_J = 25\text{ }^{\circ}\text{C}$ , $V_{BUS} = 400\text{ V}$ , $L_{HB}$ current = 2<br>A, at below high-side slew rate<br>settings, see <a href="#">GaN Power FET Switching<br/>Parameters</a> |     |      |     |      |
|                                    |                                  | slew rate setting 0 (slowest)                                                                                                                                                                                                                                        |     | 20   |     | V/ns |
|                                    |                                  | slew rate setting 1                                                                                                                                                                                                                                                  |     | 65   |     |      |
|                                    |                                  | slew rate setting 2                                                                                                                                                                                                                                                  |     | 90   |     |      |
| slew rate setting 3 (fastest)      |                                  | 165                                                                                                                                                                                                                                                                  |     |      |     |      |

1) Symbol definitions:  $V_{DS(is)}$  = SW to SL voltage;  $I_{DS(is)}$  = SW to SL current;  $V_{DS(hs)}$  = DH to SW voltage;  $I_{D(hs)}$  = DH to SW current; 2) Unless otherwise noted: voltage, resistance, and capacitance are respect to AGND;  $-40\text{ }^{\circ}\text{C} \leq T_J \leq 125\text{ }^{\circ}\text{C}$ ;  $10 \leq V_{AUX} \leq 26$ ;  $7.5 \leq V_{BST\_SW} \leq 26$ ;  $V_{EN} = 5\text{ V}$ ;  $V_{INL} = 0\text{ V}$ ;  $V_{INH} = 0\text{ V}$ ;  $R_{RDRV L} = 0\text{ }\Omega$ ;  $R_{RDRV H\_SW} = 0\text{ }\Omega$ ;  $R_{CS} = 100\text{ }\Omega$

| PARAMETER  |                                                | TEST CONDITIONS                                                                                                                                                        | MIN | TYP | MAX | UNIT          |
|------------|------------------------------------------------|------------------------------------------------------------------------------------------------------------------------------------------------------------------------|-----|-----|-----|---------------|
| <b>CS</b>  |                                                |                                                                                                                                                                        |     |     |     |               |
|            | Settling time                                  | From $I_{CS} > 0.1 \cdot I_{CS(src)(final)}$ to $I_{CS} < 0.9 \cdot I_{CS(src)(final)}$ , Low-side enabled into a 2 A load, $0\text{ V} \leq V_{CS} \leq 2\text{ V}$ , |     |     | 35  | ns            |
| <b>EN</b>  |                                                |                                                                                                                                                                        |     |     |     |               |
|            | EN wake-up time                                | $V_{INL} = 5\text{ V}$ , From $V_{EN} > V_{IT+}$ to $I_{D(is)} > 10\text{ mA}$                                                                                         |     | 1   |     | $\mu\text{s}$ |
| <b>BST</b> |                                                |                                                                                                                                                                        |     |     |     |               |
|            | Start-up time from deep BST to SW discharge    | From $V_{BST\_SW} \geq V_{BST\_SW,T+(UVLO)}$ to high-side reacts to INH rising edge with $V_{BST\_SW}$ rising from 0 V to 10 V in 1 $\mu\text{s}$                      |     | 5   |     | $\mu\text{s}$ |
|            | Start-up time from shallow BST to SW discharge | From $V_{BST\_SW} \geq V_{BST\_SW,T+(UVLO)}$ to high-side reacts to INH rising edge with $V_{BST\_SW}$ rising from 5 V to 10 V in 0.5 $\mu\text{s}$                    |     | 2   |     | $\mu\text{s}$ |

### 6.7 Typical Characteristics

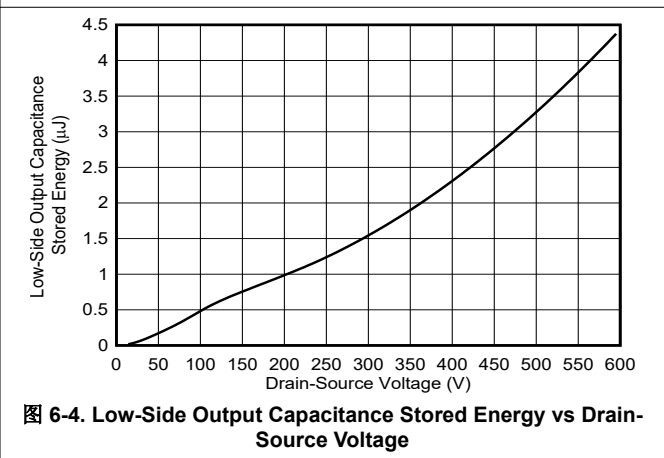
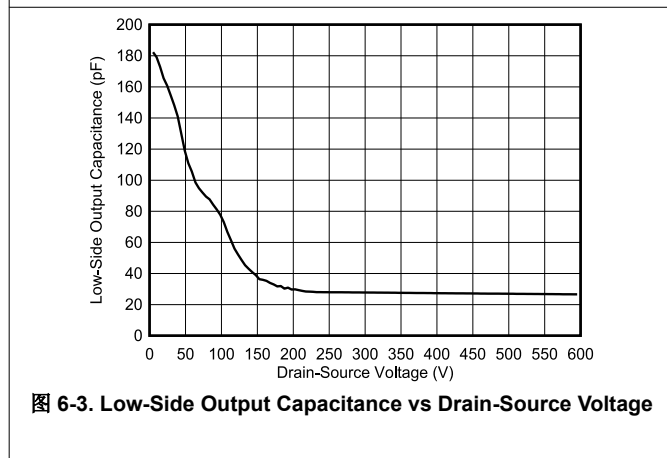
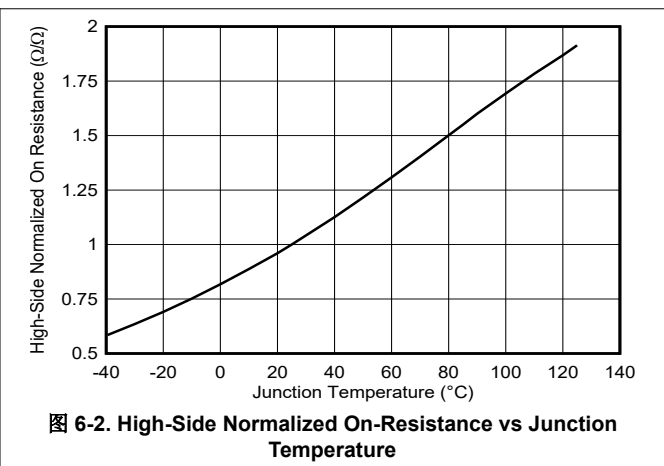
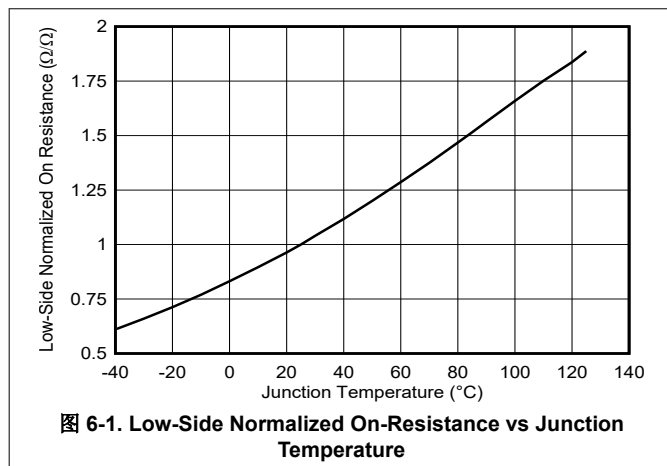

### 6.7 Typical Characteristics (continued)



图 6-5. High-Side Output Capacitance vs Drain-Source Voltage



图 6-6. High-Side Output Capacitance Stored Energy vs Drain-Source Voltage

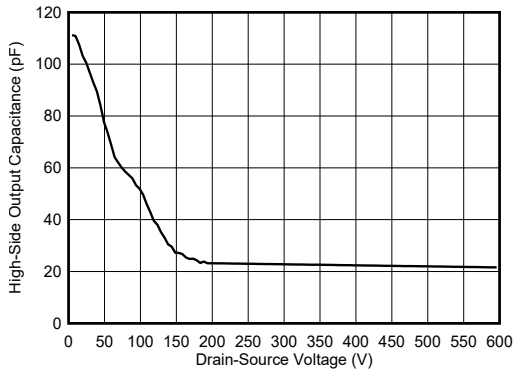

图 6-7. Low-Side Drain Current Turn-On Delay Time vs Junction Temperature

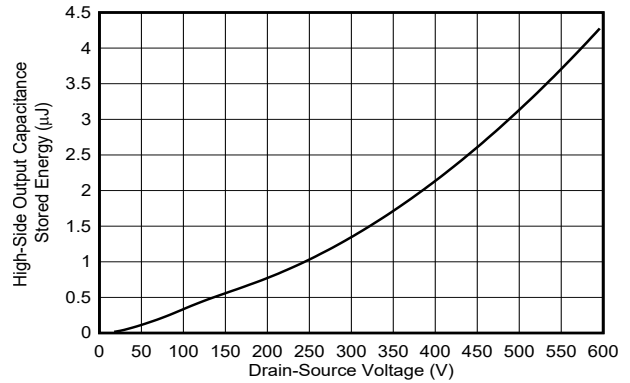

图 6-8. Low-Side Turn-On Delay Time vs Junction Temperature

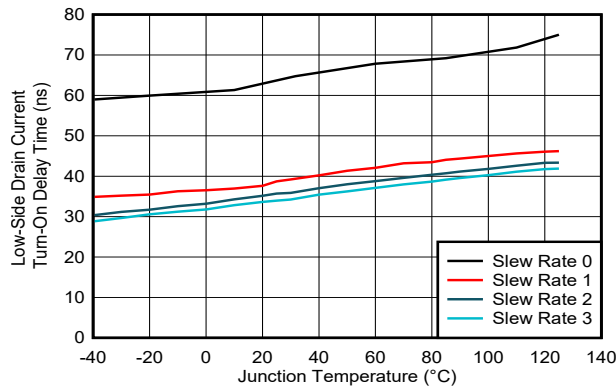

图 6-9. Low-Side Turn-On Rise Time vs Junction Temperature

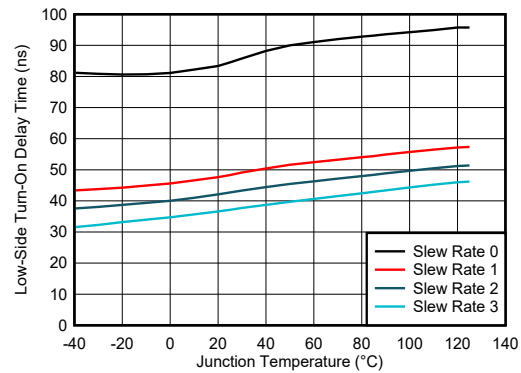

图 6-10. Low-Side Turn-On Slew Rate vs Junction Temperature

### 6.7 Typical Characteristics (continued)

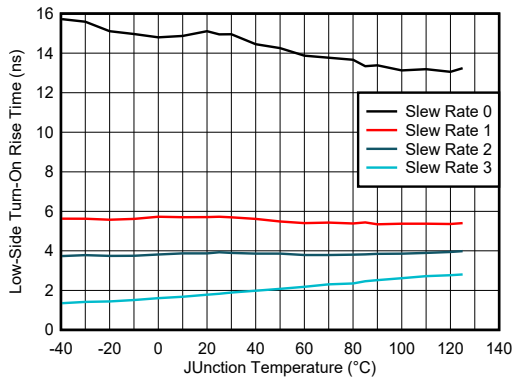

图 6-11. Low-Side Turn-Off Delay Time vs Junction Temperature

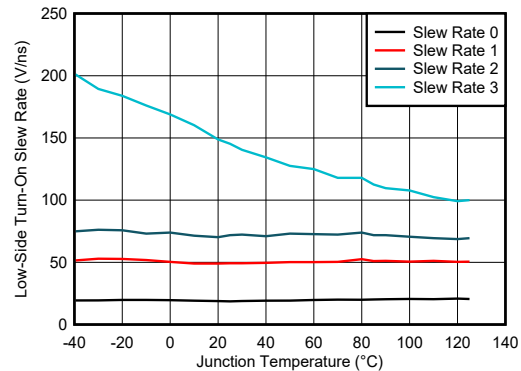

图 6-12. High-Side Drain Current Turn-On Delay Time vs Junction Temperature

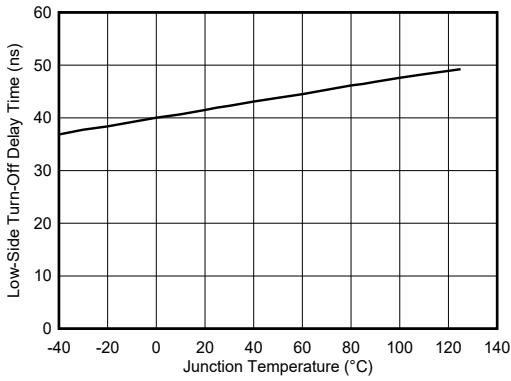

图 6-13. High-Side Turn-On Delay Time vs Junction Temperature

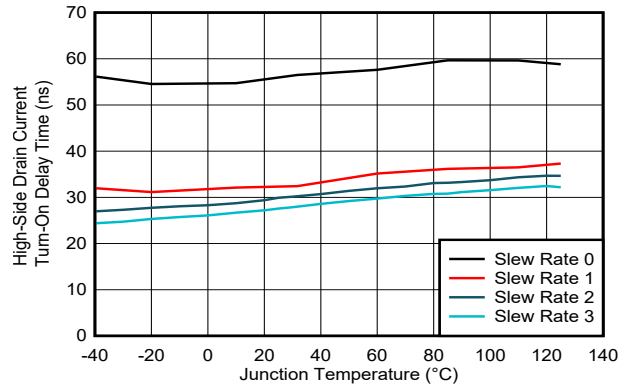

图 6-14. High-Side Turn-On Rise Time vs Junction Temperature

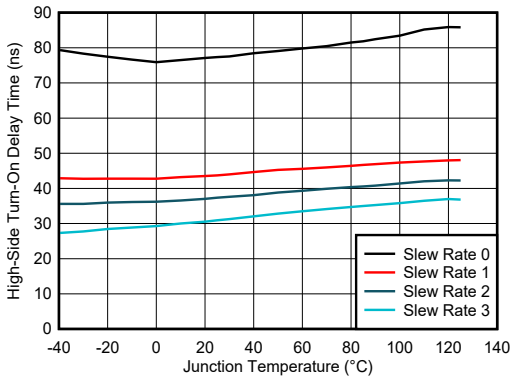

图 6-15. High-Side Turn-On Slew Rate vs Junction Temperature

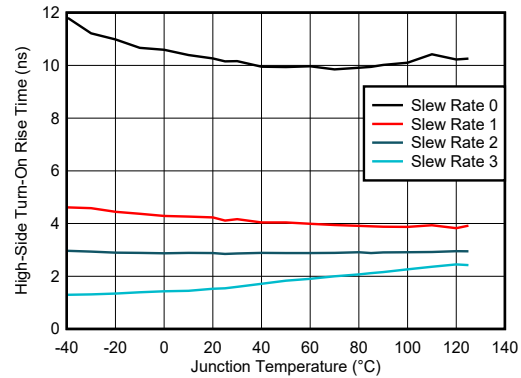

图 6-16. High-Side Turn-Off Delay Time vs Junction Temperature

### 6.7 Typical Characteristics (continued)

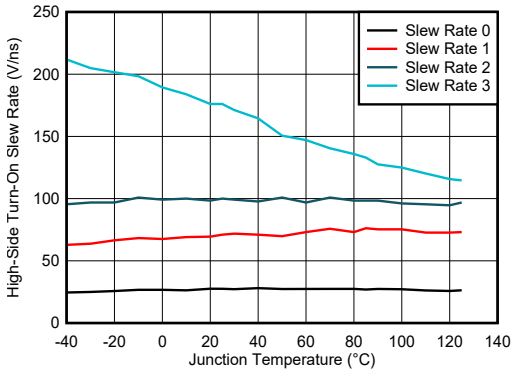

图 6-17. AUX Standby Current vs Junction Temperature

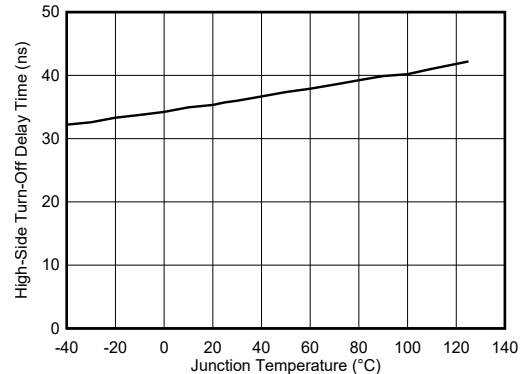

图 6-18. AUX Quiescent Current vs Junction Temperature

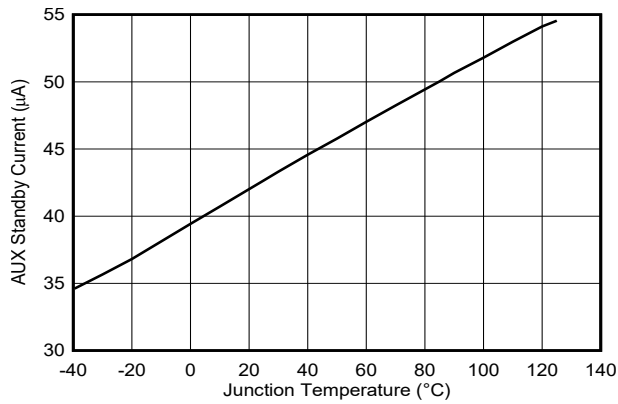

图 6-19. AUX Quiescent Current vs Junction Temperature

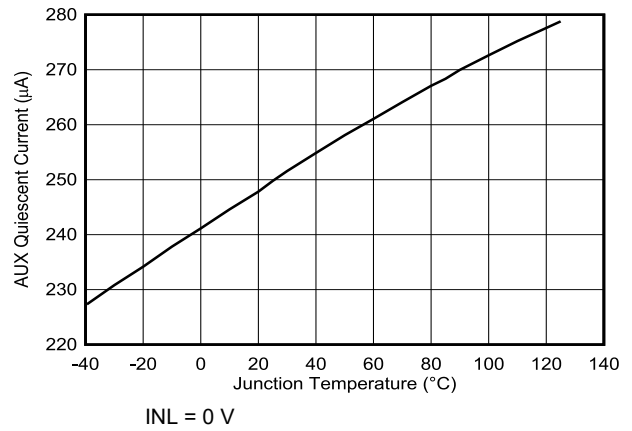

图 6-20. AUX Operating Current vs Frequency

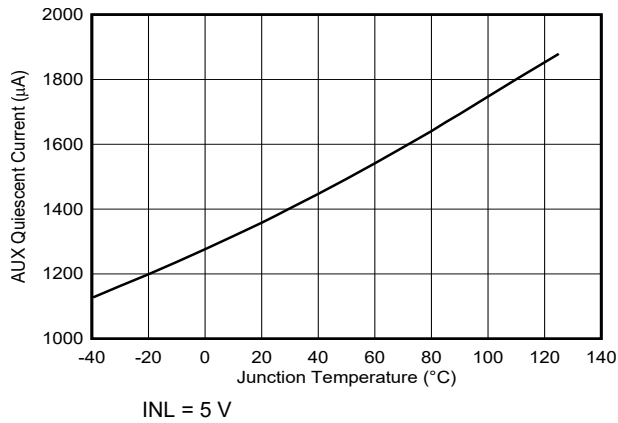

图 6-21. BST Quiescent Current vs Junction Temperature

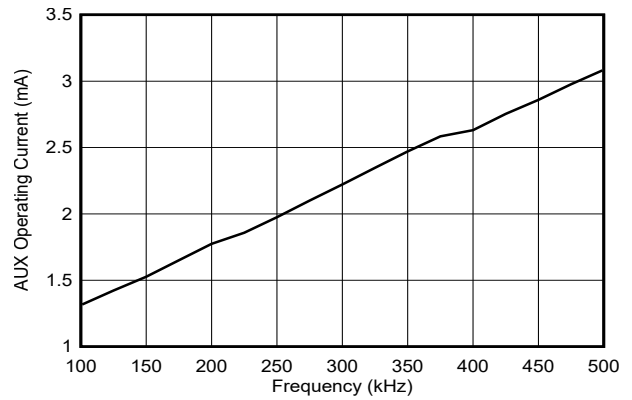

图 6-22. BST Quiescent Current vs Junction Temperature

### 6.7 Typical Characteristics (continued)

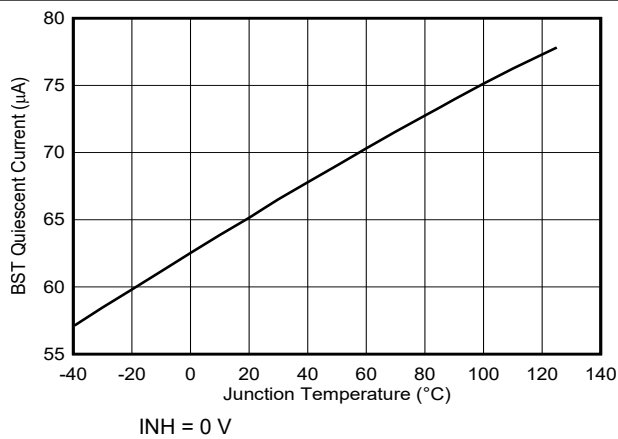

图 6-23. BST Operating Current vs Junction Temperature

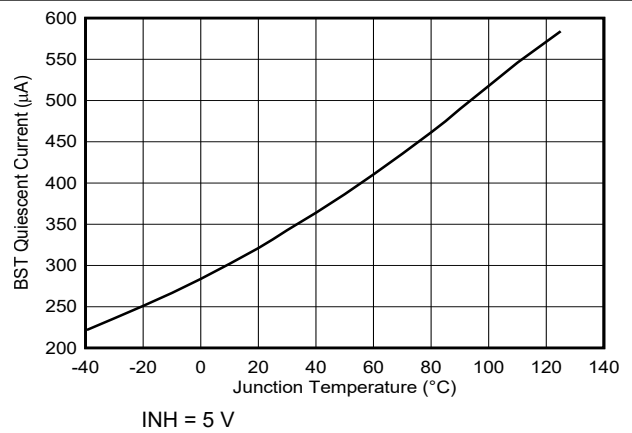

## 7 Parameter Measurement Information

### 7.1 GaN Power FET Switching Parameters

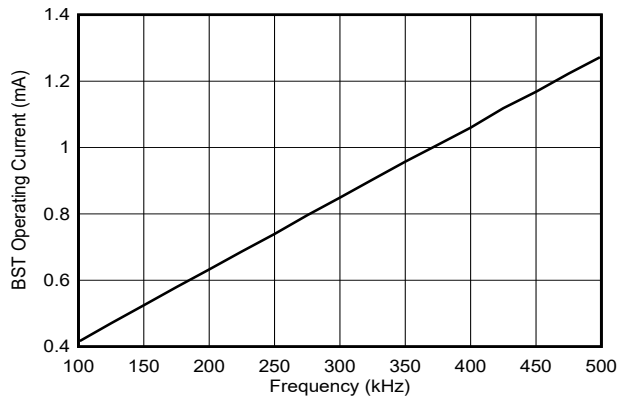
图 7-1 shows the circuit used to measure the GaN power FET switching parameters. The circuit is operated as a double-pulse tester. Consult external references for double-pulse tester details. The circuit is placed in the boost configuration to measure the low-side GaN switching parameters. The circuit is placed in the buck configuration to measure the high-side GaN switching parameters. The GaN FET not being measured in each configuration (high-side in the boost and low-side in the buck) acts as the double-pulse tester diode and circulates the inductor current in the off-state, third-quadrant conduction mode. 表 7-1 shows the details for each configuration.



图 7-1. GaN Power FET Switching Parameters Test Circuit

表 7-1. GaN Power FET Switching Parameters Test Circuit Configuration Details

| Configuration | GaN FET Under Test | GaN FET Acting as Diode | S <sub>BOOST</sub> | S <sub>BUCK</sub> | V <sub>INL</sub>      | V <sub>INH</sub>      |
|---------------|--------------------|-------------------------|--------------------|-------------------|-----------------------|-----------------------|
| Boost         | Low-side           | High-side               | Closed             | Open              | Double-pulse waveform | 0 V                   |
| Buck          | High-side          | Low-side                | Open               | Closed            | 0 V                   | Double-pulse waveform |

图 7-2 shows the GaN power FET switching parameters.

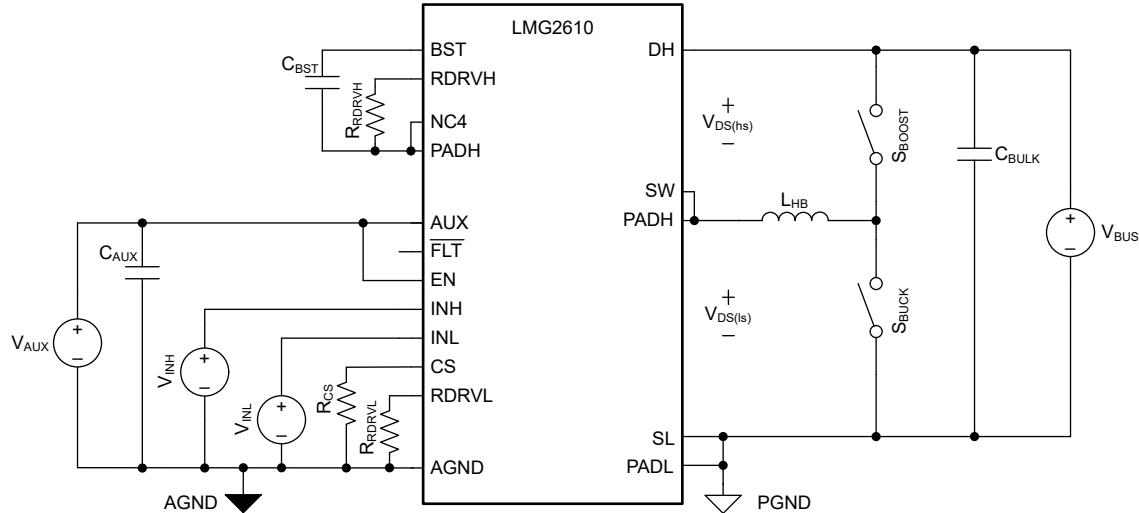
The GaN power FET turn-on transition has three timing components: drain-current turn-on delay time, turn-on delay time, and turn-on rise time. Note that the turn-on rise time is the same as the V<sub>DS</sub> 80% to 20% fall time. All three turn-on timing components are a function of the RDRVx pin setting.

The GaN power FET turn-off transition has two timing components: turn-off delay time, and turn-off fall time. Note that the turn-off fall time is the same as the V<sub>DS</sub> 20% to 80% rise time. The turn-off timing components are independent of the RDRVx pin setting, but heavily dependent on the L<sub>HB</sub> current.

The turn-on slew rate is measured over a smaller voltage delta (100 V) compared to the turn-on rise time voltage delta (240 V) to obtain a faster slew rate which is useful for EMI design. The RDRVx pin is used to program the slew rate.



图 7-2. GaN Power FET Switching Parameters

## 8 Detailed Description

### 8.1 Overview

The LMG2610 is a highly-integrated 650-V GaN power-FET half bridge intended for use in active-clamp flyback (ACF) converters. The LMG2610 combines the half-bridge power FETs, gate drivers, low-side current-sense emulation function, high-side gate-drive level shifter, and bootstrap diode function in a 9-mm by 7-mm QFN package.

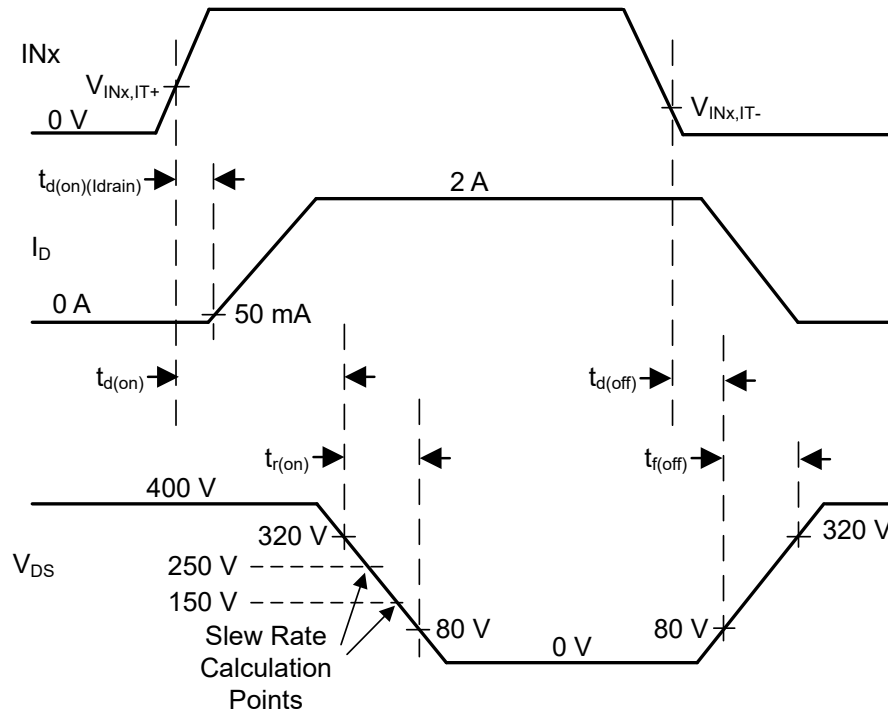
The 650-V rated GaN power FETs support the large transformer turns ratios needed to minimize the secondary-side synchronous-rectifier voltage requirements in flyback converter applications. The GaN half-bridge low output-capacitive charge reduces both the time and energy needed for ACF zero-voltage switching (ZVS) and is the key characteristic needed to create small, efficient power converters.

The GaN half-bridge consists of a 170-m $\Omega$  low-side FET and a 248-m $\Omega$  high-side FET. The asymmetric GaN half-bridge FET sizes are a good utilization of total GaN FET size for ACF operating conditions.

The LMG2610 internal gate drivers regulate the drive voltage for optimum GaN power-FET on-resistance. Internal drivers also reduce total gate inductance and GaN FET common-source inductance for improved switching performance, including common-mode transient immunity (CMTI). The low-side / high-side GaN FET turn-on slew rates can be individually programmed to one of four discrete settings for design flexibility with respect to power loss, switching-induced ringing, and EMI.

Current-sense emulation places a scaled replica of the low-side drain current on the output of the CS pin. The CS pin is terminated with a resistor to AGND to create the current-sense input signal to the external power supply controller. This CS pin resistor replaces the traditional current-sense resistor, placed in series with the low-side GaN FET source, at significant power and space savings. Furthermore, with no current-sense resistor in series with the GaN source, the low-side GaN FET thermal pad can be connected directly to the PCB power ground. This thermal pad connection both improves system thermal performance and provides additional device routing flexibility since full device current can be conducted through the thermal pads.

The high-side gate-drive level-shifter reduces the capacitive coupling of the sensitive high-side gate drive path for lower noise susceptibility and better CMTI compared to external solutions where the signal path has a much larger PCB footprint. The level shifter also has minimal impact on device quiescent current and no impact on device start-up time compared to external solutions with worse quiescent current and start up performance.

The bootstrap diode function between AUX and BST is implemented with a smart-switched GaN bootstrap FET. The switched GaN bootstrap FET allows more complete charging of the BST-to-SW capacitor since the on-state GaN bootstrap FET does not have the forward voltage drop of a traditional bootstrap diode. The smart-switched GaN bootstrap FET also avoids the traditional bootstrap diode problem of BST-to-SW capacitor overcharging due to off-state third-quadrant current flow in the low-side half-bridge GaN power FET. Finally, the bootstrap function has more efficient switching due to low capacitance and no reverse-recovery charge compared to the traditional bootstrap diode.

The AUX input supply wide voltage range is compatible with the corresponding wide range supply rail created by power supply controllers. The BST input supply range is even wider on the low end to account for capacitive droop in between bootstrap recharge cycles. Low AUX / BST idle quiescent currents and fast BST start-up time support converter burst-mode operation critical for meeting government light-load efficiency mandates. Further AUX quiescent current reduction is obtained by placing the device in standby mode with the EN pin.

The INL, INH, and EN control pins have high input impedance, low input threshold voltage and maximum input voltage equal to the AUX voltage. This allows the pins to support both low voltage and high voltage input signals and be driven with low-power outputs.

The LMG2610 protection features are low-side / high-side under-voltage lockout (UVLO), low-side / high-side input gate-drive interlock, low-side / high-side cycle-by-cycle current limit, and over-temperature shut down. The UVLO features also help achieve well-behaved converter operation. The over-temperature shut down is reported on the open drain FLT output.

## 8.2 Functional Block Diagram

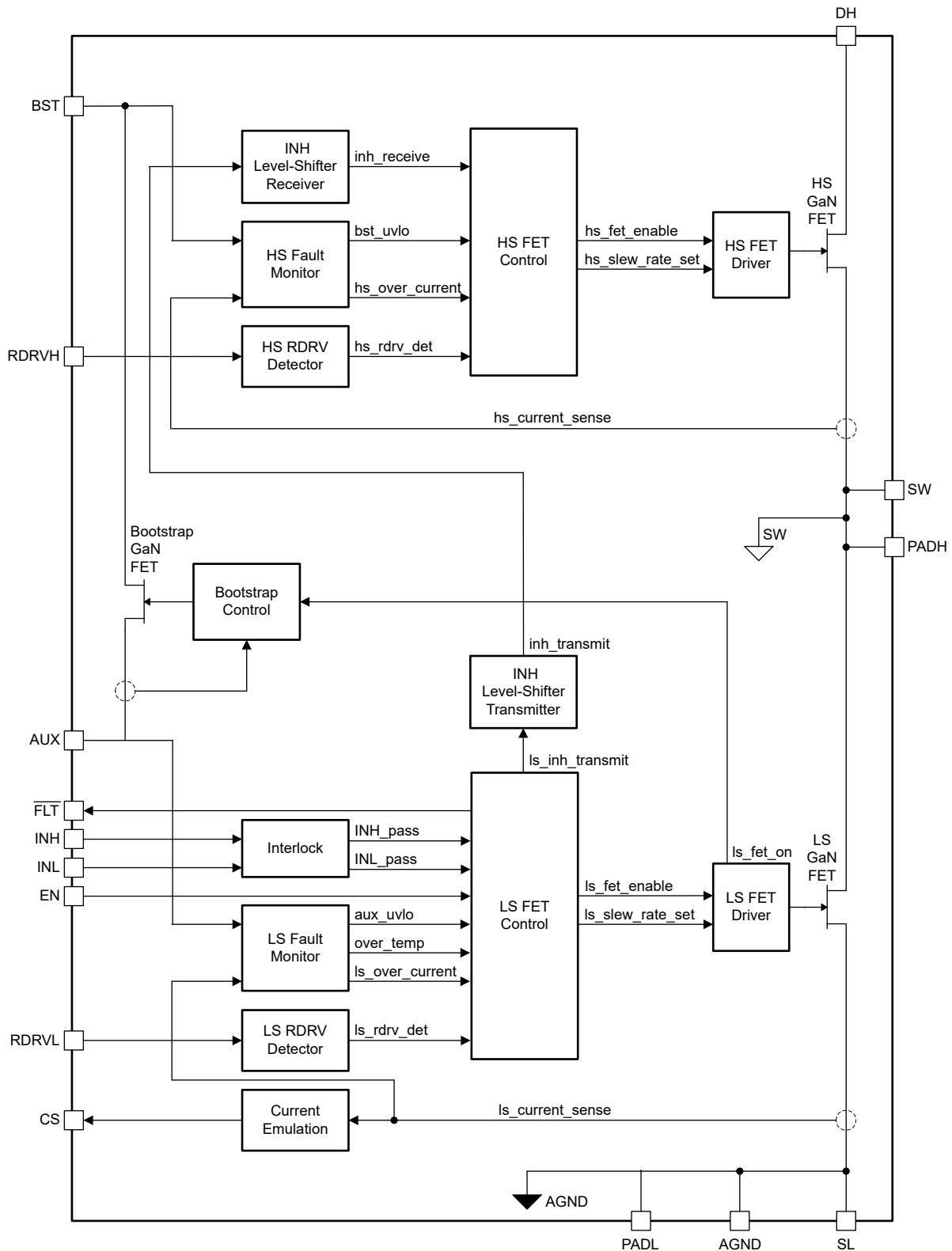

## 8.3 Feature Description

### 8.3.1 GaN Power FET Switching Capability

Due to the silicon FET's long reign as the dominant power-switch technology, many designers are unaware that the nameplate drain-source voltage cannot be used as an equivalent point to compare devices across technologies. The nameplate drain-source voltage of a silicon FET is set by the avalanche breakdown voltage. The nameplate drain-source voltage of a GaN FET is set by the long term compliance to data sheet specifications.

Exceeding the nameplate drain-source voltage of a silicon FET can lead to immediate and permanent damage. Meanwhile, the breakdown voltage of a GaN FET is much higher than the nameplate drain-source voltage. For example, the breakdown drain-source voltage of the LMG2610 GaN power FET is more than 800 V which allows the LMG2610 to operate at conditions beyond an identically nameplate rated silicon FET.

The LMG2610 GaN power FET switching capability is explained with the assistance of [Figure 8-1](#). The figure shows the drain-source voltage versus time for the LMG2610 GaN power FET for four distinct switch cycles in a switching application. No claim is made about the switching frequency or duty cycle. The first two cycles show normal operation and the second two cycles show operation during a rare input voltage surge. The LMG2610 GaN power FETs are intended to be turned on in either zero-voltage switching (ZVS) or discontinuous-conduction mode (DCM) switching conditions.



图 8-1. GaN Power FET Switching Capability

Each cycle starts before  $t_0$  with the FET in the on state. At  $t_0$  the GaN FET turns off and parasitic elements cause the drain-source voltage to ring at a high frequency. The high frequency ringing has damped out by  $t_1$ . Between  $t_1$  and  $t_2$  the FET drain-source voltage is set by the characteristic response of the switching application. The characteristic is shown as a flat line (plateau), but other responses are possible. At  $t_2$  the GaN FET is turned on. For normal operation, the transient ring voltage is limited to 650 V and the plateau voltage is limited to 520 V. For rare surge events, the transient ring voltage is limited to 800 V and the plateau voltage is limited to 720 V.

### 8.3.2 Turn-On Slew-Rate Control

The turn-on slew rate of both the low-side and high-side GaN power FETs are individually programmed to one of four discrete settings. The low-side slew rate is programmed by the resistance between the RDRV L and AGND pins. The high-side slew rate is programmed by the resistance between the RDRV H and SW pins. The low-side slew-rate setting is determined one time during AUX power up when the AUX voltage goes above the *AUX Power-On Reset* voltage. The high-side slew-rate setting is determined one time during BST-to-SW power up when the BST-to-SW voltage goes above the *BST Power-On Reset* voltage. The slew-rate setting determination time is not specified but is around 0.4 us.

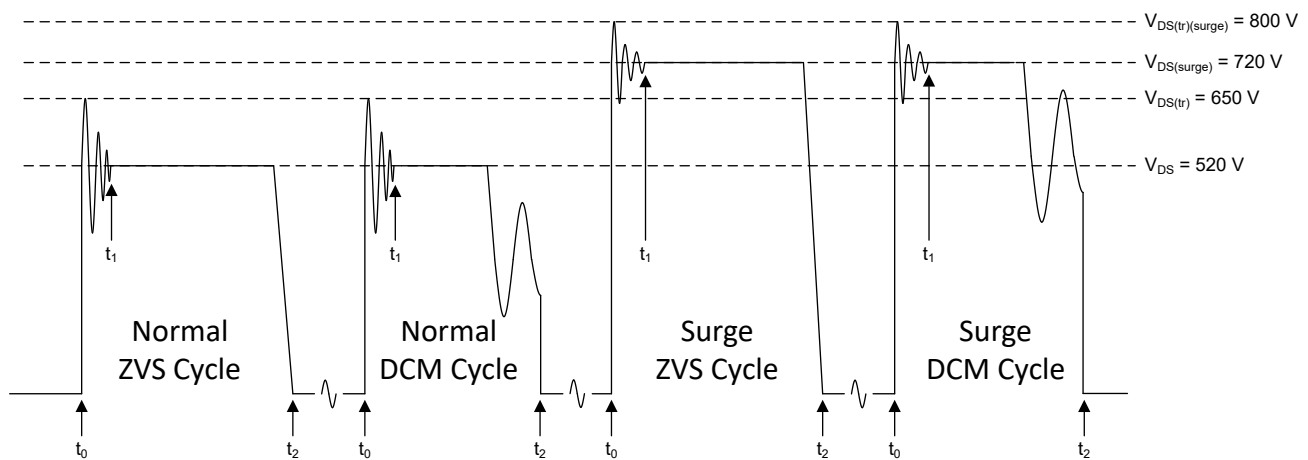
表 8-1 shows the recommended typical resistance programming value for the four slew rate settings and the typical turn-on slew rate at each setting. As noted in the table, an open-circuit connection is acceptable for programming slew-rate setting 0 and a short-circuit connection (RDRV L shorted to AGND for the low-side turn-on slew rate) (RDRV H shorted to SW for the high-side turn-on slew rate) is acceptable for programming slew-rate setting 3.

表 8-1. Slew-Rate Setting

| Turn-On Slew Rate Setting | Recommended Typical Programming Resistance (kΩ) | Typical LS / HS Turn-On Slew Rate (V/ns) | Comment                                                                                                                                                           |
|---------------------------|-------------------------------------------------|------------------------------------------|-------------------------------------------------------------------------------------------------------------------------------------------------------------------|
| 0                         | 120                                             | 20 / 20                                  | Open-circuit connection for programming resistance is acceptable.                                                                                                 |
| 1                         | 47                                              | 50 / 65                                  |                                                                                                                                                                   |
| 2                         | 22                                              | 70 / 90                                  |                                                                                                                                                                   |
| 3                         | 5.6                                             | 140 / 165                                | Short-circuit connection for programming resistance (RDRV L shorted to AGND for low-side slew rate) (RDRV H shorted to SW for high-side slew rate) is acceptable. |

### 8.3.3 Current-Sense Emulation

The current-sense emulation function creates a scaled replica of the low-side GaN power FET positive drain current at the output of the CS pin. The current-sense emulation gain,  $G_{CSSE}$ , is 1 mA output from the CS pin,  $I_{CS}$  for every 1 A passing into the drain of the low-side GaN power FET,  $I_D$ .

$$G_{CSSE} = I_{CS} / I_D = 1 \text{ mA} / 1 \text{ A} = 0.001 \quad (1)$$

The CS pin is terminated with a resistor to AGND,  $R_{CS}$ , to create the current-sense voltage input signal to the external power supply controller.

$R_{CS}$  is determined by solving for the traditional current-sense design resistance,  $R_{CS(trad)}$ , and multiplying by the inverse of  $G_{CSSE}$ . The traditional current-sense design creates the current-sense voltage,  $V_{CS(trad)}$ , by passing the low-side GaN power FET drain current,  $I_D$ , through  $R_{CS(trad)}$ . The LMG2610 creates the current-sense voltage,  $V_{CS}$ , by passing the CS pin output current,  $I_{CS}$ , through  $R_{CS}$ . The current-sense voltage must be the same for both designs.

$$V_{CS} = I_{CS} * R_{CS} = V_{CS(trad)} = I_D * R_{CS(trad)} \quad (2)$$

$$R_{CS} = I_D / I_{CS} * R_{CS(trad)} = 1 / G_{CSSE} * R_{CS(trad)} \quad (3)$$

$$R_{CS} = 1000 * R_{CS(trad)} \quad (4)$$

The CS pin is clamped internally to a typical 2.5 V. The clamp protects vulnerable power-supply controller current-sense input pins from over voltage if, for example, the current sense resistor on the CS pin were to become disconnected.

图 8-2 shows the current-sense emulation operation. In both cycles, the CS pin current emulates the low-side GaN power-FET drain current while the low-side FET is enabled. The first cycle shows normal operation where the controller turns off the low-side GaN power FET when the controller current-sense input threshold is tripped. The second cycle shows a fault situation where the LMG2610 *Over-Current Protection* turns off the low-side GaN power FET before the controller current-sense input threshold is tripped. In this second cycle, the LMG2610 avoids a hung controller INL pulse by generating a fast-ramping artificial current-sense emulation signal to trip the controller current-sense input threshold. The artificial signal persists until the INL pin goes to logic-low which indicates the controller is back in control of switch operation.



图 8-2. Current-Sense Emulation Operation

### 8.3.4 Bootstrap Diode Function

The internal bootstrap diode function is implemented with a smart-switched GaN bootstrap FET. The GaN bootstrap FET blocks current in both directions between AUX and BST when The GaN bootstrap FET is turned off.

The bootstrap diode function is active when the low-side GaN power FET is turned on and inactive when the low-side GaN power FET is turned off. The GaN bootstrap FET is held off in the bootstrap diode inactive phase. The GaN bootstrap FET is turned on a single time at the beginning of the bootstrap active phase and is controlled as an ideal diode with diode current flowing from AUX to BST to charge the BST-to-SW capacitor. If a small reverse current from BST to AUX is detected after the GaN bootstrap FET is turned on, the GaN bootstrap FET is turned off for the remainder of the bootstrap active phase.

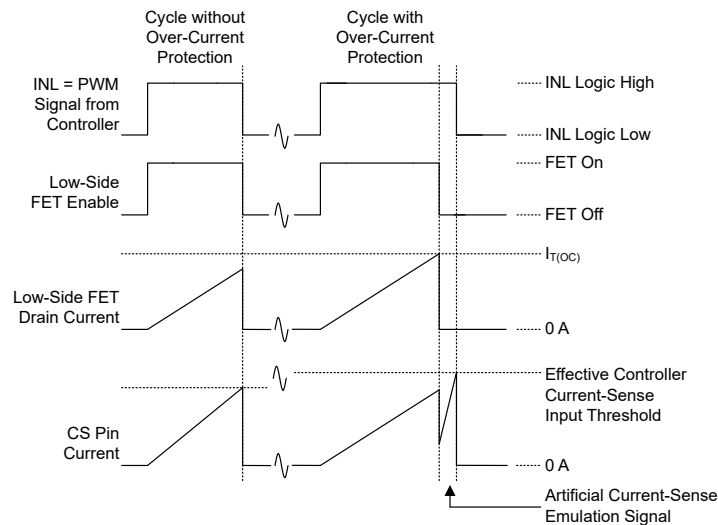
The bootstrap diode function implements a current limit to protect the GaN bootstrap FET when the BST-to-SW capacitor is significantly discharged at the beginning of the bootstrap active phase. If there is no current limit situation during the GaN bootstrap FET turn on, or if the bootstrap function drops out of current limit as the BST-to-SW capacitor charges, the current limit function is disabled for the remainder of the GaN bootstrap FET turn-on time. The current limit function is disabled to save quiescent current.

### 8.3.5 Input Control Pins (EN, INL, INH)

The EN pin is used to toggle the device between the active and standby modes described in [Device Functional Modes](#).

The INL pin is used to turn the low-side GaN power FET on and off.

The INH pin is used to turn the high-side GaN power FET on and off.

The input control pins have a typical 1-V input-voltage-threshold hysteresis for noise immunity. The pins also have a typical 400 k $\Omega$  pull-down resistance to protect against floating inputs. The 400 k $\Omega$  saturates for typical input voltages above 4 V to limit the maximum input pull-down current to a typical 10  $\mu$ A.

The INL turn-on action is impacted by the following conditions 1) [Standby Mode](#), 2) [AUX UVLO](#), 3) INH in control of [Interlock](#), 4) Low-Side [Over-Current Protection](#), and 5) [Over-Temperature Protection](#).

The INH turn-on action is impacted by the following conditions 1) [Standby Mode](#), 2) [AUX UVLO](#), 3) INL in control of [Interlock](#), 4) High-Side [Over-Current Protection](#), and 5) [Over-Temperature Protection](#).

The [Standby Mode](#), [AUX UVLO](#), and [Over-Temperature Protection](#) are the universal INL / INH blocking conditions. These conditions hold both GaN half-bridge power FETs off independent of INL and INH.  8-3 shows the Universal Blocking Condition Operation. Note that the high-side FET does not turn on at transition #4. INH only turns on the high-side FET if there is no universal blocking condition when INH goes to logic high. This avoids an incomplete high-side FET turn-on period which can create undesired spike voltages in the converter.



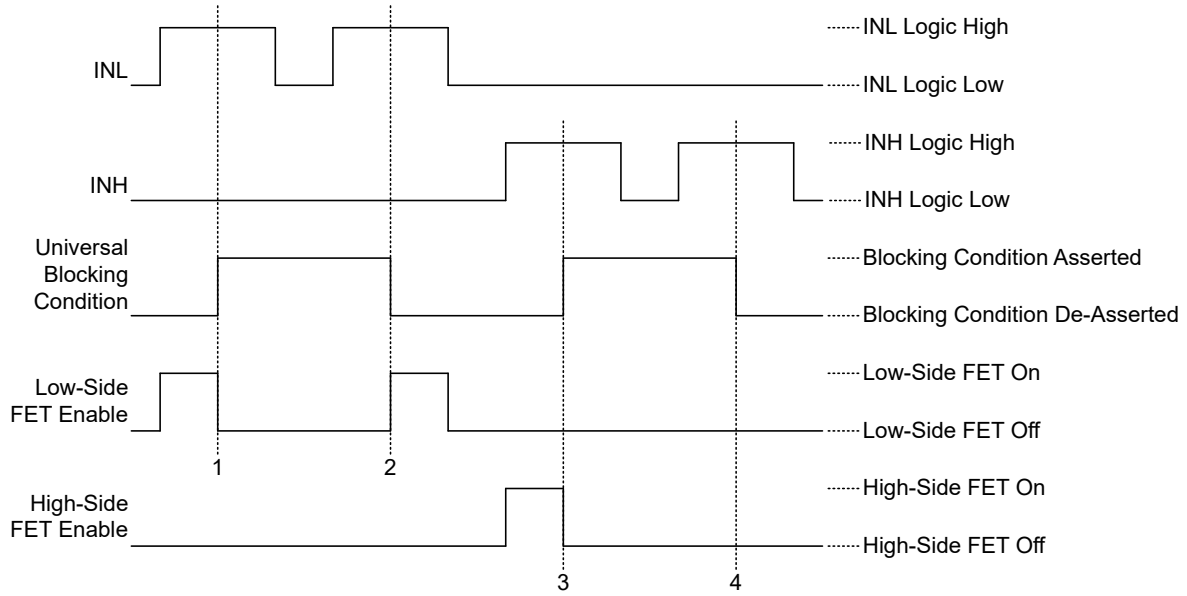

**图 8-3. Universal INL / INH Blocking Condition Operation**

### 8.3.6 INL - INH Interlock

The interlock function keeps the low-side and high-side GaN power FETs from being simultaneously turned on when the INL and INH pins are both logic-high. Either the INL or the INH pin gains control of the interlock if it is logic high when the other pin is logic low. Once the INL or INH pin gains control of the interlock, it retains control as long as it remains logic high. Only the INL or INH pin in control of the interlock passes a logic-high signal through the interlock.

The interlock is disabled if any of the universal INL / INH blocking conditions defined in [Input Control Pins](#) are asserted. When the interlock is disabled, the interlock outputs are held at logic low. If both INL and INH are logic-high when the interlock is enabled, the INL takes priority, gains control of the interlock, and passes the INL logic-high signal through the interlock.

### 8.3.7 AUX Supply Pin

The AUX pin is the input supply for the low-side internal circuits and is the power source to charge the BST-to-SW capacitor through the internal bootstrap diode function.

#### 8.3.7.1 AUX Power-On Reset

The AUX Power-On Reset disables all low-side functionality if the AUX voltage is below the AUX Power-On Reset voltage. The AUX Power-On Reset voltage is not specified but is around 5 V. The AUX Power-On Reset initiates the one-time determination of the low-side slew-rate setting programmed on the RDRV pin if the AUX voltage goes above the AUX Power-On Reset voltage. The AUX Power-On Reset enables the over-temperature protection function if the AUX voltage is above the AUX Power-On Reset voltage.

#### 8.3.7.2 AUX Under-Voltage Lockout (UVLO)

The AUX UVLO holds off both the low-side and high-side GaN power FETs if the AUX voltage is below the AUX UVLO voltage. The AUX UVLO voltage is set higher than the BST UVLO voltage so the high-side GaN power FET can be operated when the low-side GaN power FET is operating. The voltage separation between the AUX UVLO voltage and BST UVLO voltage accounts for operating conditions where the bootstrap charging of the BST-to-SW capacitor from the AUX supply is incomplete. The AUX UVLO voltage hysteresis prevents on-off chatter near the UVLO voltage trip point.

### 8.3.8 BST Supply Pin

The BST pin is the input supply for the high-side internal circuits. The BST pin and corresponding high-side circuits are referenced to the SW pin. The BST pin is powered by the low-side AUX Supply pin through the internal bootstrap diode function. The bootstrap function is inactive when the low-side GaN FET is off and the BST pin must rely on an external BST-to-SW capacitor for the BST power source.

Designing the BST-to-SW capacitance is a trade-off between high-side charge-up time and hold-up time. The BST-to-SW external capacitance is recommended to be a ceramic capacitor that is at least 10 nF over operating conditions.

#### 8.3.8.1 BST Power-On Reset

The BST Power-On Reset voltage is with respect to the SW pin. The BST Power-On Reset disables all high-side functionality if the BST-to-SW voltage is below the BST Power-On Reset voltage. The BST Power-On Reset voltage is not specified but is around 5 V. The BST Power-On Reset initiates the one-time determination of the high-side slew-rate setting programmed on the RDRVH pin if the BST-to-SW voltage goes above the BST Power-On Reset voltage.

#### 8.3.8.2 BST Under-Voltage Lockout (UVLO)

The BST UVLO voltage is with respect to the SW pin. The BST UVLO only controls the high-side GaN power FET. The BST UVLO does not control the low-side GaN power FET. The BST UVLO consists of two separate UVLO functions to create a two-level BST UVLO. The upper BST UVLO is called the BST Turn-On UVLO and only controls if the high-side GaN power FET is turned on. The lower BST UVLO is called the BST Turn-Off UVLO and only controls if the high-side GaN power FET is turned off after the high-side GaN power FET is turned on. The operation of the two-level UVLO is not the same as a single UVLO with wide hysteresis.

图 8-4 shows the BST UVLO operation. The BST Turn-On UVLO prevents the high-side GaN power FET from turning on at a INH logic-high rising edge if the BST-to-SW voltage is below the BST Turn-On UVLO voltage - INH pulses #1, #2, and #5. After the high-side GaN power FET is successfully turned-on, the BST Turn-On UVLO is ignored and the BST Turn-Off UVLO output is watched for the remainder of the INH logic-high pulse - INH pulses #3, #4, and #6. The BST Turn-Off UVLO turns off the high-side GaN power FET for the remainder of the INH logic-high pulse if the BST-to-SW voltage falls below the BST Turn-Off UVLO voltage - INH pulse #6.



图 8-4. BST UVLO Operation

The effective voltage hysteresis of the two-level BST UVLO is the difference between the upper and lower BST UVLO voltages. A single-level BST UVLO can be implemented with the same hysteresis but allows subsequent high-side GaN power FET turn on anywhere in the hysteresis range. The two-level UVLO design prevents any turn on in the hysteresis range. A single-level BST UVLO would allow INH pulse #5 to turn on the high-side GaN power FET.

The two-level BST UVLO allows a wide hysteresis while making sure the BST-to-SW capacitor is adequately charged at the beginning of every INH pulse. The wide hysteresis allows a smaller BST-to-SW capacitor to be used which is useful for faster high-side start-up time. The adequate capacitor charge at the beginning of the INH pulse helps make sure the high-side GaN power FET is not turned-off early in the INH pulse which can create undesired spike voltages in the converter.

### 8.3.9 Over-Current Protection

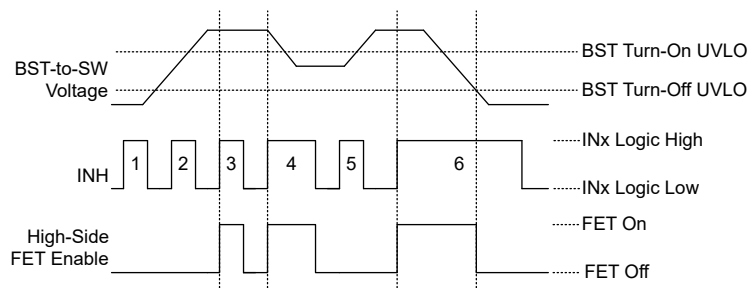
The LMG2610 implements cycle-by-cycle over-current protection for both half-bridge GaN power FETs. [图 8-5](#) shows the cycle-by-cycle over-current operation. Every INx logic-high cycle turns on the GaN power FET. If the GaN power FET drain current exceeds the over-current threshold current, the over-current protection turns off the GaN power FET for the remainder of the INx logic-high duration.

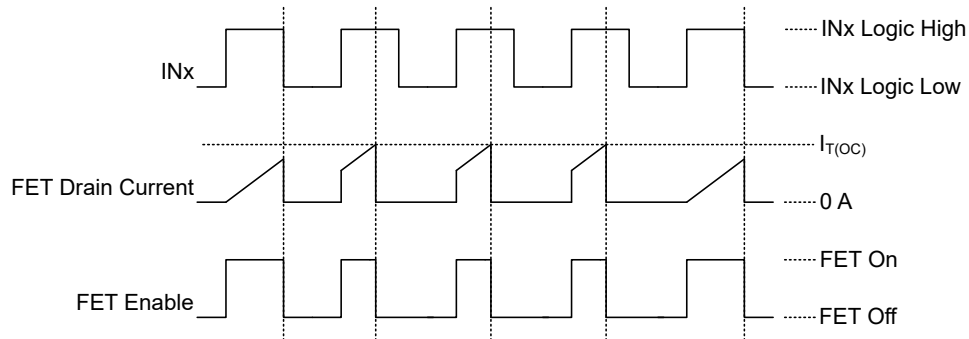

**图 8-5. Cycle-by-Cycle Over-Current Protection Operation**

An over-current protection event is not reported on the  $\overline{\text{FLT}}$  pin. Cycle-by-cycle over-current protection minimizes system disruption because the event is not reported and because the protection allows the GaN power FET to turn on every INx cycle.

The low-side / high-side over-current protection threshold currents are set to different levels corresponding to the different GaN power FET sizes. As described in [Current-Sense Emulation](#), an artificial CS pin current is produced after the low-side GaN power FET is turned off by the low-side over-current protection, to prevent the controller from entering a hung state.

### 8.3.10 Over-Temperature Protection

The over-temperature protection holds off both the low-side and high-side GaN power FETs if the LMG2610 temperature is above the over-temperature shut-down temperature. The over-temperature shut-down hysteresis avoids erratic thermal cycling. An over-temperature fault is reported on the  $\overline{\text{FLT}}$  pin when the over-temperature protection is asserted. This is the only fault event reported on the  $\overline{\text{FLT}}$  pin. The over-temperature protection is enabled when the AUX voltage is above the [AUX Power-On Reset](#) voltage. The low AUX Power-On Reset voltage helps the over-temperature protection remain operational when the AUX rail droops during the cool-down phase.

### 8.3.11 Fault Reporting

The LMG2610 only reports an over-temperature fault. An over-temperature fault is reported on the  $\overline{\text{FLT}}$  pin when the [Over-Temperature Protection](#) function is asserted. The  $\overline{\text{FLT}}$  pin is an active low open-drain output so the pin pulls low when there is an over-temperature fault.

## 8.4 Device Functional Modes

The LMG2610 has two modes of operation controlled by the EN pin. The device is in Active mode when the EN is logic high and in Standby mode when the EN pin is logic low. In active mode, the half-bridge GaN power FETs are controlled by the INL and INH pins. In Standby mode, the INL and INH pins are ignored, the half-bridge GaN power FETs are held off, and the AUX quiescent current is reduced to the AUX standby quiescent current.

## 9 Application and Implementation

---

### 备注

Information in the following applications sections is not part of the TI component specification, and TI does not warrant its accuracy or completeness. TI's customers are responsible for determining suitability of components for their purposes, as well as validating and testing their design implementation to confirm system functionality.

---

### 9.1 Application Information

The LMG2610 is a GaN power-FET half bridge intended for use in off-line active-clamp flyback (ACF) converters. The LMG2610 provides plug-and-play simplicity since it integrates the half-bridge FETs, FET gate drivers, high-side gate-drive level shifter, bootstrap diode function, and current-sense emulation in a single package. The typical application example shows the LMG2610 pairing seamlessly with the Texas Instruments UCC28782 ACF controller to create a high-power-density, high-efficiency, 65-W, USB-PD charger.

## 9.2 Typical Application



图 9-1. 65-W USB-PD Charger Application

## 9.2.1 Design Requirements

**表 9-1. Electrical Performance Specifications**

| PARAMETER                     |                                                                 | TEST CONDITIONS                                                                                | MIN | TYP         | MAX   | UNIT |
|-------------------------------|-----------------------------------------------------------------|------------------------------------------------------------------------------------------------|-----|-------------|-------|------|
| <b>INPUT CHARACTERISTICS</b>  |                                                                 |                                                                                                |     |             |       |      |
| $V_{IN}$                      | Input line voltage (RMS)                                        |                                                                                                | 90  | 115 / 230   | 264   | V    |
| $f_{LINE}$                    | Input line frequency                                            |                                                                                                | 47  | 50 / 60     | 63    | Hz   |
| $P_{STBY}$                    | Input power at no-load, $V_O = 5\text{ V}$                      | $V_{IN} = 230\text{ V}_{RMS}, I_O = 0\text{ A}$                                                |     | 55          | 70    | mW   |
|                               |                                                                 | $V_{IN} = 115\text{ V}_{RMS}, I_O = 0\text{ A}$                                                |     | 45          | 70    | mW   |
| $P_{0.25W}$                   | Input power at 0.25-W load, $V_O = 20\text{ V}$                 | $V_{IN} = 230\text{ V}_{RMS}, P_O = 250\text{ mW}$                                             |     | 399         | 470   | mW   |
|                               |                                                                 | $V_{IN} = 115\text{ V}_{RMS}, P_O = 250\text{ mW}$                                             |     | 359         | 470   | mW   |
| <b>OUTPUT CHARACTERISTICS</b> |                                                                 |                                                                                                |     |             |       |      |
| $V_O$                         | Output voltage, 20-V setting                                    | $V_{IN} = 90\text{ to }264\text{ V}_{RMS}, I_O = 0\text{ A to }3.25\text{ A}$                  |     | 19.95       |       | V    |
|                               | Output voltage, 15-V setting                                    | $V_{IN} = 90\text{ to }264\text{ V}_{RMS}, I_O = 0\text{ A to }3\text{ A}$                     |     | 15.06       |       |      |
|                               | Output voltage, 9-V setting                                     | $V_{IN} = 90\text{ to }264\text{ V}_{RMS}, I_O = 0\text{ A to }3\text{ A}$                     |     | 9.05        |       |      |
|                               | Output voltage, 5-V setting                                     | $V_{IN} = 90\text{ to }264\text{ V}_{RMS}, I_O = 0\text{ A to }3\text{ A}$                     |     | 5.05        |       |      |
| $I_{O(FL)}$                   | Full-load rated output current, 20-V setting                    | $V_{IN} = 90\text{ to }264\text{ V}_{RMS}, V_O = 20\text{ V}$                                  |     | 3.25        |       | A    |
| $I_{O(FL2)}$                  | Full-load rated output current, 15-V, 9-V, 5-V settings         | $V_{IN} = 90\text{ to }264\text{ V}_{RMS}, V_O = 15\text{ V, }9\text{ V, }5\text{ V}$          |     | 3.00        |       | A    |
| $V_{O\_PP}$                   | Output ripple voltage, peak to peak 20-V setting                | $V_{IN} = 90\text{ to }264\text{ V}_{RMS}, I_O = 0\text{ A to }3.25\text{ A}$                  |     | 150         | 600   | mVpp |
|                               | Output ripple voltage, peak to peak 15-V setting                | $V_{IN} = 90\text{ to }264\text{ V}_{RMS}, I_O = 0\text{ A to }3\text{ A}$                     |     | 150         | 450   |      |
|                               | Output ripple voltage, peak to peak 9-V setting                 | $V_{IN} = 90\text{ to }264\text{ V}_{RMS}, I_O = 0\text{ A to }3\text{ A}$                     |     | 150         | 300   |      |
|                               | Output ripple voltage, peak to peak 5-V setting                 | $V_{IN} = 90\text{ to }264\text{ V}_{RMS}, I_O = 0\text{ A to }3\text{ A}$                     |     | 150         | 200   |      |
| $P_{O(OPP)}$                  | Over-power protection threshold                                 | $V_{IN} = 90\text{ to }264\text{ V}_{RMS}$                                                     |     | 70          |       | W    |
| $t_{OPP}$                     | Over-power protection duration                                  | $V_{IN} = 90\text{ to }264\text{ V}_{RMS}, P_O > P_{O(OPP)}$                                   |     | 160         |       | ms   |
| $\Delta V_O$                  | Output voltage deviation during step-load transient             | $V_O = 20\text{ V}, I_O$ step between 0 A to $I_{O(FL)}$ at 100 Hz                             |     | -604 / +340 | ±1000 | mVpp |
| <b>SYSTEM CHARACTERISTICS</b> |                                                                 |                                                                                                |     |             |       |      |
| $\eta_{FL\_20}$               | Full-load efficiency, $V_O = 20\text{ V}$                       | $V_{IN} = 230\text{ V}_{RMS}, I_O = 3.25\text{ A}$                                             | 94% | 94.2%       |       |      |
|                               |                                                                 | $V_{IN} = 115\text{ V}_{RMS}, I_O = 3.25\text{ A}$                                             | 94% | 94.2%       |       |      |
|                               |                                                                 | $V_{IN} = 90\text{ V}_{RMS}, I_O = 3.25\text{ A}$                                              | 93% | 93.3%       |       |      |
| $\eta_{avg\_20}$              | 4-point average efficiency <sup>(1)</sup> , $V_O = 20\text{ V}$ | $V_{IN} = 230\text{ V}_{RMS}$                                                                  | 89% | 93.4%       |       |      |
|                               |                                                                 | $V_{IN} = 115\text{ V}_{RMS}$                                                                  | 89% | 92.4%       |       |      |
| $\eta_{10\%\_20}$             | Efficiency at 10% load, $V_O = 20\text{ V}$                     | $V_{IN} = 230\text{ V}_{RMS}, I_O = 10\%$ of $I_{O(FL)}$                                       | 79% | 83.8%       |       |      |
|                               |                                                                 | $V_{IN} = 115\text{ V}_{RMS}, I_O = 10\%$ of $I_{O(FL)}$                                       | 79% | 89.0%       |       |      |
| $T_{AMB}$                     | Ambient operating temperature range                             | $V_{IN} = 90\text{ to }264\text{ V}_{RMS}, V_O = 20\text{ V}, I_O = 0\text{ to }3.25\text{ A}$ |     | 25°C        |       |      |

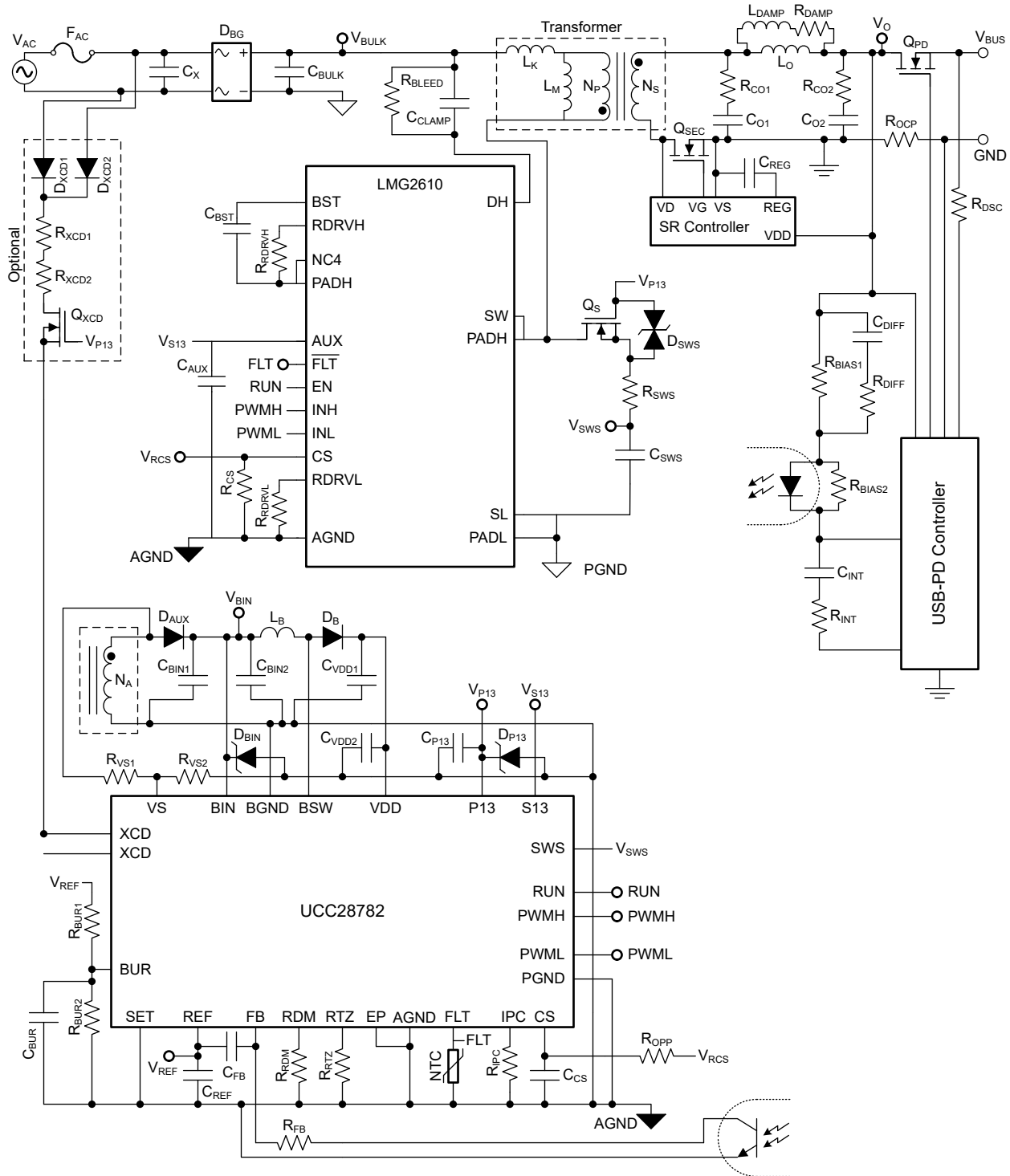
(1) Average efficiency of four load points,  $I_O = 100\%, 75\%, 50\%$ , and  $25\%$  of  $I_{O(FL)}$ .

## 9.2.2 Detailed Design Procedure

The 65-W USB-PD Charger Application is adapted from the typical application found in the [UCC28782 High-Density Active-Clamp Flyback Controller](#) data sheet. The UCC28782 data sheet detailed design procedure is not repeated here. Refer to the UCC28782 data sheet for the details in designing the active-clamp flyback primary-side power stage and in using the UCC28782 controller. This detailed design procedure focuses on the specifics of using the LMG2610 in the application.

### 9.2.2.1 Turn-On Slew-Rate Design

The LMG2610 turn-on slew rates are programmed as discussed in [Turn-On Slew-Rate Control](#). In normal active-clamp flyback (ACF) operation the high-side power switch operates at zero-voltage switching (ZVS), so the high-side turn-on time does not affect the switch node slew rate. Therefore, the high-side GaN power FET is programmed to turn on as fast as possible to minimize high-side GaN power-FET third-quadrant losses. The fastest high-side turn-on time is programmed by setting

$$R_{DRVH} < 5.6 \text{ k}\Omega \quad (5)$$

In normal ACF operation, the low-side power switch operates at both ZVS and non-ZVS valley switching depending on the load condition. The valley switching occurs at zero transformer current. Therefore, the low-side is programmed to turn on as slow as possible to minimize EMI and circuit ringing with no additional switching loss penalty. The slowest low-side turn-on time is programmed by setting

$$R_{DRVL} > 120 \text{ k}\Omega \quad (6)$$

### 9.2.2.2 Current-Sense Design

The [UCC28782 High-Density Active-Clamp Flyback Controller](#) data sheet shows the calculation for a traditional current sense resistor,  $R_{CS(UCC28782)}$ , in series with the low-side power switch current.  $R_{CS}$  is calculated with [方程式 4](#)

$$R_{CS} = 1000 * R_{CS(UCC28782)} \quad (7)$$

The  $R_{OPP(UCC2872)}$  determination in the [UCC28782 High-Density Active-Clamp Flyback Controller](#) data sheet assumes the current sense resistor is very small.  $R_{OPP}$  is adjusted to account for the significant  $R_{CS}$  value.

$$R_{OPP} = R_{OPP(UCC2872)} - R_{CS} \quad (8)$$

## 9.3 Power Supply Recommendations

The LMG2610 operates from a single input supply connected to the AUX pin. The BST pin is powered internally by the AUX pin. The LMG2610 is intended to be operated from the same supply managed and used by the power supply controller. The wide recommended AUX voltage range of 10 V to 26 V overlaps common-controller supply-pin turn-on and UVLO voltage limits.

The BST-to-SW external capacitance is recommended to be a ceramic capacitor that is at least 10 nF over operating conditions.

The AUX external capacitance is recommended to be a ceramic capacitor that is at least three-times larger than the BST-to-SW capacitance over operating conditions.



## 9.4 Layout

### 9.4.1 Layout Guidelines

#### 9.4.1.1 Solder-Joint Stress Relief

Large QFN packages can experience high solder-joint stress. Several best practices are recommended to provide solder-joint stress relief. First, the instructions for the NC1, NC2, and NC3 anchor pins found in [表 5-1](#) must be followed. Second, all the board solder pads must be non-solder-mask defined (NSMD) as shown in the land pattern example in the *Mechanical Data*. Finally, any board trace connected to an NSMD pad must be less than 2/3 the width of the pad on the pad side where it is connected. The trace must maintain this 2/3 width limit for as long as it is not covered by solder mask. After the trace is under solder mask, there are no limits on the trace dimensions. All these recommendations are followed in the [Layout Example](#).

#### 9.4.1.2 Signal-Ground Connection

Design the power supply with separate signal and power grounds that only connect in one location. Connect the LMG2610 AGND pin to signal ground. Connect the LMG2610 SL pin and PADL thermal pad to power ground. The LMG2610 serves as the single connection point between the signal and power grounds since the AGND pin, SL pin, and PADL thermal pad are connected internally. Do not connect the signal and power grounds anywhere else on the board except as recommended in the next sentence. To facilitate board debug with the LMG2610 not installed, connect the AGND pad to the PADL thermal pad as shown in the [Layout Example](#).

#### 9.4.1.3 CS Pin Signal

As seen with [方程式 4](#), the current-sense signal impedance is three orders of magnitude higher than a traditional current-sense signal. This higher impedance has implications for current-sense signal noise susceptibility. Minimize routing the current-sense signal near any noisy traces. Place the current-sense resistor and any filtering capacitors at the far end of the trace next to the controller current-sense input pin.

### 9.4.2 Layout Example



图 9-2. PCB Top Layer (First Layer)



图 9-3. PCB Inner Layer (Second Layer)

## 10 Device and Documentation Support

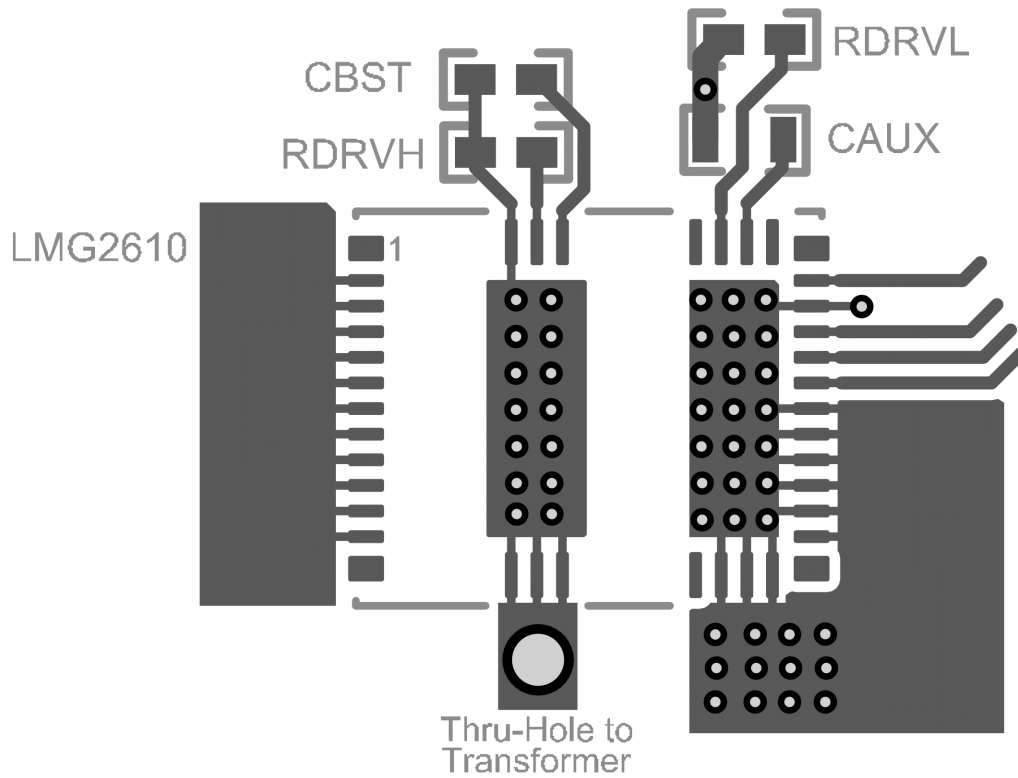
TI offers an extensive line of development tools. Tools and software to evaluate the performance of the device, generate code, and develop solutions are listed below.

### 10.1 Documentation Support

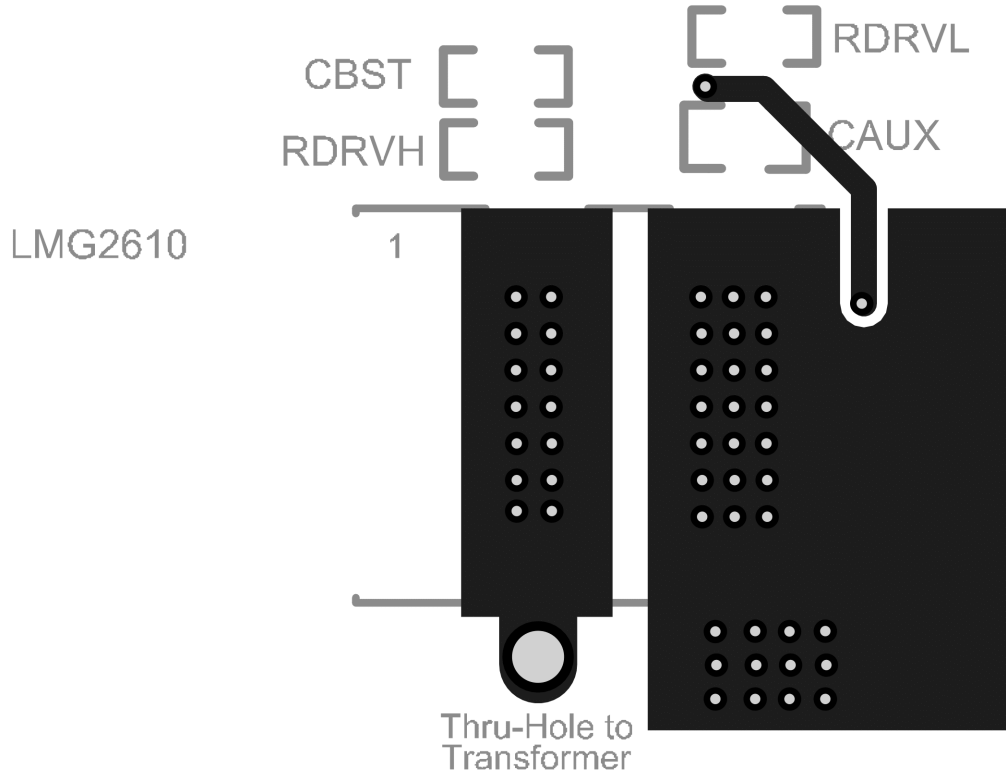
#### 10.1.1 Related Documentation

The [LMG2610 Active-Clamp Flyback Power Stage Design Calculator](#) is an Excel-based calculation tool for LMG2610 design.

[Using the UCC28782EVM-030 65-W USB-C PD High-Density Active-Clamp Flyback Converter](#) is a User Guide for the EVM

#### 10.2 接收文档更新通知

要接收文档更新通知，请导航至 [ti.com](https://www.ti.com) 上的器件产品文件夹。点击 [订阅更新](#) 进行注册，即可每周接收产品信息更改摘要。有关更改的详细信息，请查看任何已修订文档中包含的修订历史记录。

#### 10.3 支持资源

TI E2E™ [支持论坛](#)是工程师的重要参考资料，可直接从专家获得快速、经过验证的解答和设计帮助。搜索现有解答或提出自己的问题可获得所需的快速设计帮助。

链接的内容由各个贡献者“按原样”提供。这些内容并不构成 TI 技术规范，并且不一定反映 TI 的观点；请参阅 TI 的《[使用条款](#)》。

#### 10.4 Trademarks

TI E2E™ is a trademark of Texas Instruments.

所有商标均为其各自所有者的财产。

#### 10.5 Electrostatic Discharge Caution



This integrated circuit can be damaged by ESD. Texas Instruments recommends that all integrated circuits be handled with appropriate precautions. Failure to observe proper handling and installation procedures can cause damage.

ESD damage can range from subtle performance degradation to complete device failure. Precision integrated circuits may be more susceptible to damage because very small parametric changes could cause the device not to meet its published specifications.

#### 10.6 术语表

[TI 术语表](#) 本术语表列出并解释了术语、首字母缩略词和定义。

## 11 Mechanical, Packaging, and Orderable Information

The following pages include mechanical, packaging, and orderable information. This information is the most current data available for the designated devices. This data is subject to change without notice and revision of this document. For browser-based versions of this data sheet, refer to the left-hand navigation.

RRG0040A-C01



### PACKAGE OUTLINE

VQFN - 1.0 mm max height

PLASTIC QUAD FLATPACK - NO LEAD

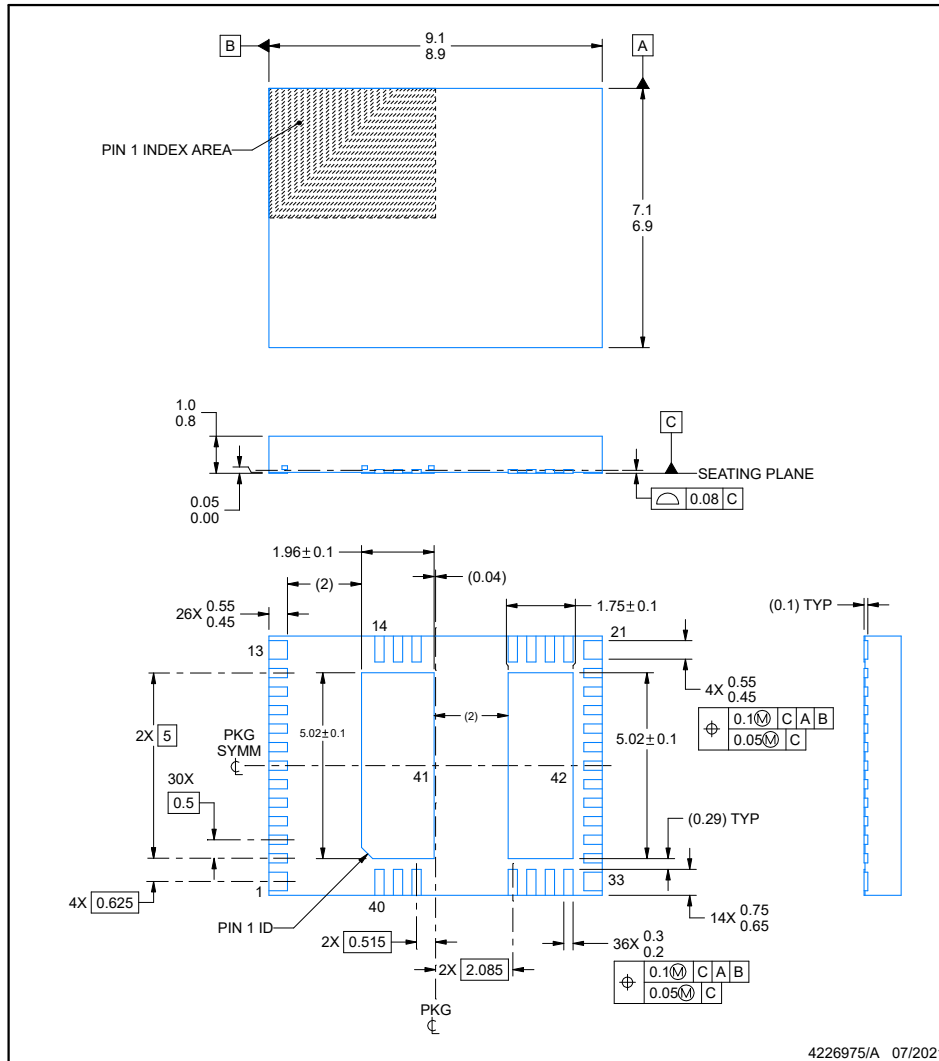

**NOTES:**

1. All linear dimensions are in millimeters. Any dimensions in parenthesis are for reference only. Dimensioning and tolerancing per ASME Y14.5M.
2. This drawing is subject to change without notice.
3. The package thermal pad must be soldered to the printed circuit board for thermal and mechanical performance.

### EXAMPLE BOARD LAYOUT

### RRG0040A-C01

### VQFN - 1.0 mm max height

PLASTIC QUAD FLATPACK - NO LEAD

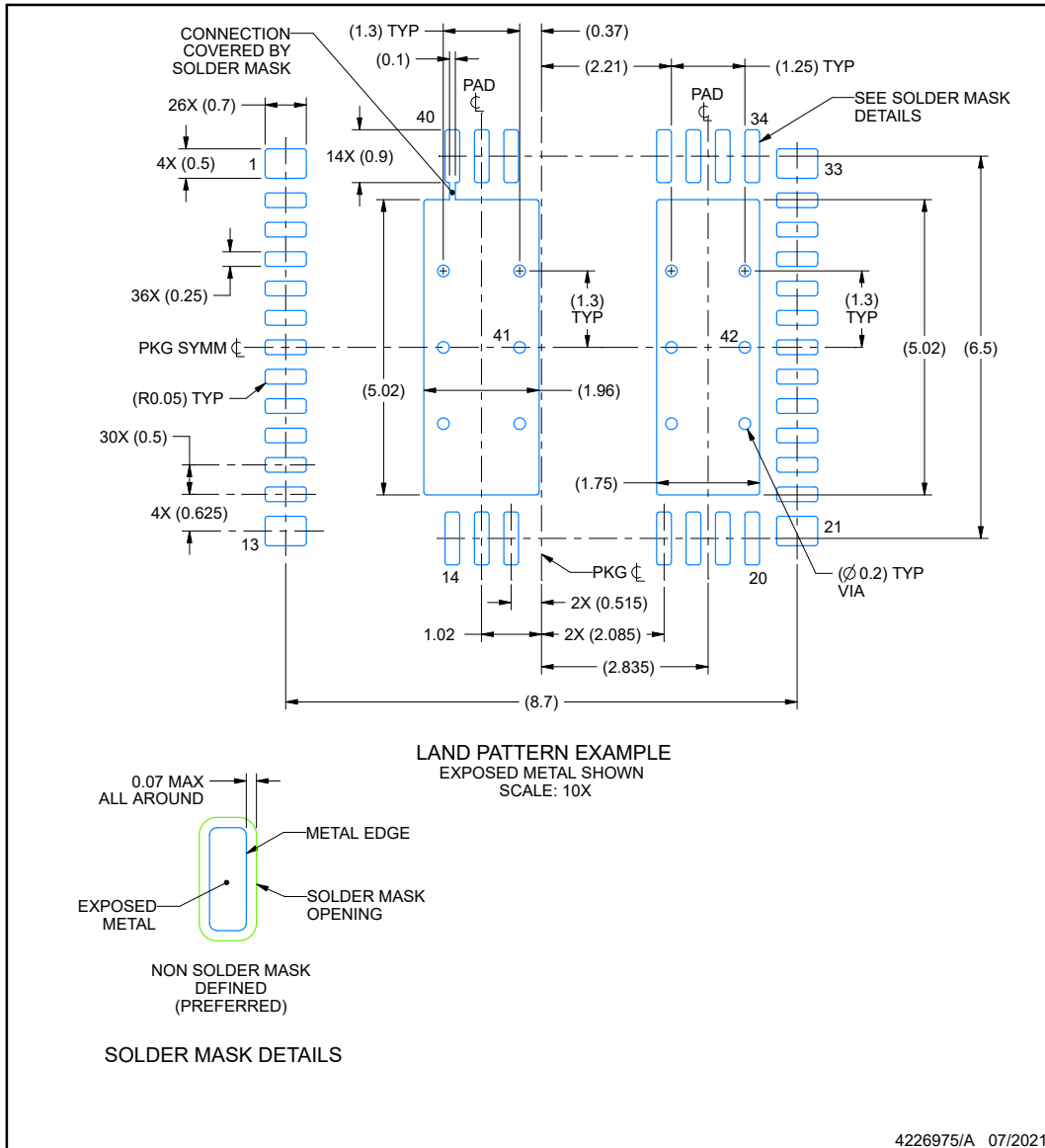

NOTES: (continued)

- This package is designed to be soldered to a thermal pad on the board. For more information, see Texas Instruments literature number SLUA271 ([www.ti.com/lit/slua271](http://www.ti.com/lit/slua271)).
- Vias are optional depending on application, refer to device data sheet. If some or all are implemented, recommended via locations are shown.

**EXAMPLE STENCIL DESIGN**

**RRG0040A-C01**

**VQFN - 1.0 mm max height**

PLASTIC QUAD FLATPACK - NO LEAD

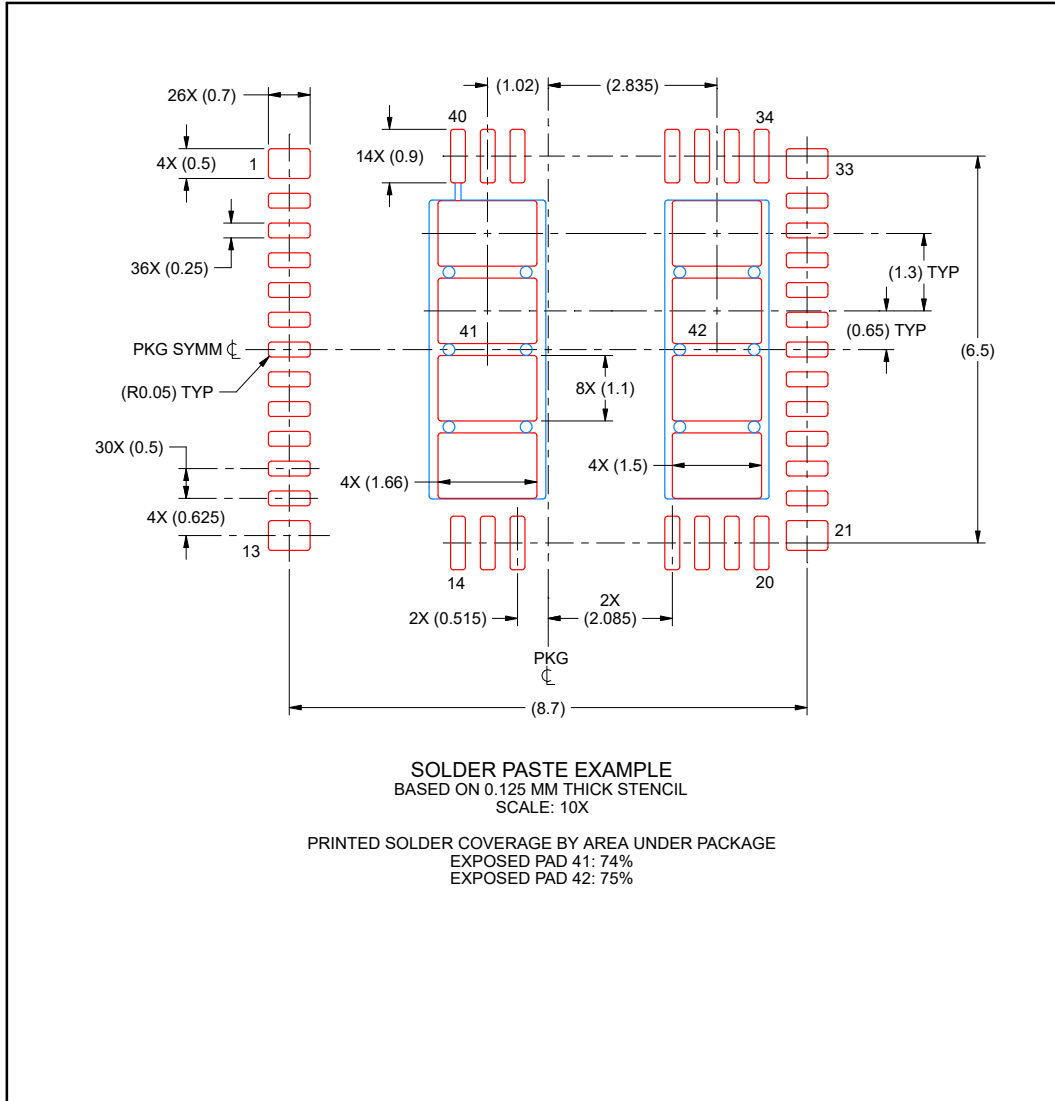

NOTES: (continued)

6. Laser cutting apertures with trapezoidal walls and rounded corners may offer better paste release. IPC-7525 may have alternate design recommendations.

**PACKAGING INFORMATION**

| Orderable Device | Status<br>(1) | Package Type | Package Drawing | Pins | Package Qty | Eco Plan<br>(2)     | Lead finish/<br>Ball material<br>(6) | MSL Peak Temp<br>(3) | Op Temp (°C) | Device Marking<br>(4/5) | Samples                 |
|------------------|---------------|--------------|-----------------|------|-------------|---------------------|--------------------------------------|----------------------|--------------|-------------------------|-------------------------|
| LMG2610RRGR      | ACTIVE        | VQFN         | RRG             | 40   | 2000        | RoHS-Exempt & Green | NIPDAU                               | Level-3-260C-168 HR  | -40 to 125   | LMG2610<br>NNNNC        | <a href="#">Samples</a> |
| LMG2610RRGT      | ACTIVE        | VQFN         | RRG             | 40   | 250         | RoHS-Exempt & Green | NIPDAU                               | Level-3-260C-168 HR  | -40 to 125   | LMG2610<br>NNNNC        | <a href="#">Samples</a> |
| XLMG2610RRGT     | ACTIVE        | VQFN         | RRG             | 40   | 250         | RoHS & Non-Green    | Call TI                              | Level-3-260C-168 HR  | -40 to 125   | XLMG2610<br>NNNNC       | <a href="#">Samples</a> |

(1) The marketing status values are defined as follows:

**ACTIVE:** Product device recommended for new designs.

**LIFEBUY:** TI has announced that the device will be discontinued, and a lifetime-buy period is in effect.

**NRND:** Not recommended for new designs. Device is in production to support existing customers, but TI does not recommend using this part in a new design.

**PREVIEW:** Device has been announced but is not in production. Samples may or may not be available.

**OBSOLETE:** TI has discontinued the production of the device.

(2) **RoHS:** TI defines "RoHS" to mean semiconductor products that are compliant with the current EU RoHS requirements for all 10 RoHS substances, including the requirement that RoHS substance do not exceed 0.1% by weight in homogeneous materials. Where designed to be soldered at high temperatures, "RoHS" products are suitable for use in specified lead-free processes. TI may reference these types of products as "Pb-Free".

**RoHS Exempt:** TI defines "RoHS Exempt" to mean products that contain lead but are compliant with EU RoHS pursuant to a specific EU RoHS exemption.

**Green:** TI defines "Green" to mean the content of Chlorine (Cl) and Bromine (Br) based flame retardants meet JS709B low halogen requirements of <=1000ppm threshold. Antimony trioxide based flame retardants must also meet the <=1000ppm threshold requirement.

(3) MSL, Peak Temp. - The Moisture Sensitivity Level rating according to the JEDEC industry standard classifications, and peak solder temperature.

(4) There may be additional marking, which relates to the logo, the lot trace code information, or the environmental category on the device.

(5) Multiple Device Markings will be inside parentheses. Only one Device Marking contained in parentheses and separated by a "~" will appear on a device. If a line is indented then it is a continuation of the previous line and the two combined represent the entire Device Marking for that device.

(6) Lead finish/Ball material - Orderable Devices may have multiple material finish options. Finish options are separated by a vertical ruled line. Lead finish/Ball material values may wrap to two lines if the finish value exceeds the maximum column width.

**Important Information and Disclaimer:**The information provided on this page represents TI's knowledge and belief as of the date that it is provided. TI bases its knowledge and belief on information provided by third parties, and makes no representation or warranty as to the accuracy of such information. Efforts are underway to better integrate information from third parties. TI has taken and continues to take reasonable steps to provide representative and accurate information but may not have conducted destructive testing or chemical analysis on incoming materials and chemicals. TI and TI suppliers consider certain information to be proprietary, and thus CAS numbers and other limited information may not be available for release.



In no event shall TI's liability arising out of such information exceed the total purchase price of the TI part(s) at issue in this document sold by TI to Customer on an annual basis.

**TAPE AND REEL INFORMATION**

**QUADRANT ASSIGNMENTS FOR PIN 1 ORIENTATION IN TAPE**

\*All dimensions are nominal

| Device      | Package Type | Package Drawing | Pins | SPQ  | Reel Diameter (mm) | Reel Width W1 (mm) | A0 (mm) | B0 (mm) | K0 (mm) | P1 (mm) | W (mm) | Pin1 Quadrant |
|-------------|--------------|-----------------|------|------|--------------------|--------------------|---------|---------|---------|---------|--------|---------------|
| LMG2610RRGR | VQFN         | RRG             | 40   | 2000 | 330.0              | 16.4               | 9.3     | 7.3     | 1.2     | 12.0    | 16.0   | Q1            |
| LMG2610RRGT | VQFN         | RRG             | 40   | 250  | 180.0              | 16.4               | 9.3     | 7.3     | 1.2     | 12.0    | 16.0   | Q1            |

**TAPE AND REEL BOX DIMENSIONS**

\*All dimensions are nominal

| Device      | Package Type | Package Drawing | Pins | SPQ  | Length (mm) | Width (mm) | Height (mm) |
|-------------|--------------|-----------------|------|------|-------------|------------|-------------|
| LMG2610RRGR | VQFN         | RRG             | 40   | 2000 | 350.0       | 350.0      | 43.0        |
| LMG2610RRGT | VQFN         | RRG             | 40   | 250  | 213.0       | 191.0      | 55.0        |

## 重要声明和免责声明

TI“按原样”提供技术和可靠性数据（包括数据表）、设计资源（包括参考设计）、应用或其他设计建议、网络工具、安全信息和其他资源，不保证没有瑕疵且不做任何明示或暗示的担保，包括但不限于对适销性、某特定用途方面的适用性或不侵犯任何第三方知识产权的暗示担保。

这些资源可供使用 TI 产品进行设计的熟练开发人员使用。您将自行承担以下全部责任：(1) 针对您的应用选择合适的 TI 产品，(2) 设计、验证并测试您的应用，(3) 确保您的应用满足相应标准以及任何其他功能安全、信息安全、监管或其他要求。

这些资源如有变更，恕不另行通知。TI 授权您仅可将这些资源用于研发本资源所述的 TI 产品的应用。严禁对这些资源进行其他复制或展示。您无权使用任何其他 TI 知识产权或任何第三方知识产权。您应全额赔偿因在这些资源的使用中对 TI 及其代表造成的任何索赔、损害、成本、损失和债务，TI 对此概不负责。

TI 提供的产品受 [TI 的销售条款](#) 或 [ti.com](#) 上其他适用条款/TI 产品随附的其他适用条款的约束。TI 提供这些资源并不会扩展或以其他方式更改 TI 针对 TI 产品发布的适用的担保或担保免责声明。

TI 反对并拒绝您可能提出的任何其他或不同的条款。

邮寄地址：Texas Instruments, Post Office Box 655303, Dallas, Texas 75265

Copyright © 2023，德州仪器 (TI) 公司