

PCM6120-Q1 2 通道、768 kHz、Burr-Brown™ 音频 ADC

1 特性

- 多通道高性能 ADC：
 - 2 通道模拟麦克风输入或线路输入
 - 4 通道数字 PDM 麦克风
 - 多达 2 个模拟和多达 2 个数字麦克风通道
- ADC 线路和麦克风差分输入性能：
 - 动态范围 (DR)：
 - 123 dB，动态范围增强器 (DRE) 启用
 - 113 dB，DRE 禁用
 - THD+N：-95 dB
- ADC 通道相加模式，DR 性能：
 - 116 dB，DRE 禁用，2 通道相加
- ADC 输入电压：
 - 差分 $2V_{RMS}$ 满量程输入
 - 单端 $1V_{RMS}$ 满量程输入
- ADC 采样率 (f_S) = 8 kHz 至 768 kHz
- 可编程通道设置：
 - 通道增益：0 dB 至 42 dB，步长 0.5 dB
 - 数字音量控制：-100 dB 至 27 dB
 - 增益校准分辨率为 0.1 dB
 - 相位校准分辨率为 163 ns
- 可编程麦克风偏置或电源电压生成
- 低延迟信号处理滤波器选择
- 可编程 HPF 和双二阶数字滤波器
- 自动增益控制器 (AGC)
- 话音激活检测 (VAD)
- I²C 控制接口
- 集成高性能音频 PLL
- 自动时钟分频器设置配置
- 音频串行数据接口：
 - 格式：TDM、I²S 或左对齐 (LJ)
 - 字长：16 位、20 位、24 位或 32 位
 - 主/从接口
- 单电源运行：3.3V 或 1.8V
- I/O 电源运行：3.3V 或 1.8V
- 1.8V AVDD 电源电压下的功耗：
 - 48 kHz 采样率下为 9.5 mW/通道

2 应用

- 汽车主动噪声消除
- 汽车音响主机
- 后座娱乐系统
- 数字驾驶舱处理单元
- 远程信息处理控制单元

3 说明

PCM6120-Q1 是一款高性能 Burr-Brown™ 音频模数转换器 (ADC)，最多可支持对脉冲密度调制 (PDM) 麦克风输入的两个模拟通道或四个数字通道进行同步采样。该器件支持线路和麦克风输入，并能够实现单端和差分输入配置。该器件集成了可编程通道增益、数字音量控制、可编程麦克风偏置电压、锁相环 (PLL)、可编程高通滤波器 (HPF)、双二阶滤波器、低延迟滤波器模式，并可实现高达 768kHz 的采样率。该器件支持时分多路复用 (TDM)、I²S 或左对齐 (LJ) 音频格式，并可通过 I²C 接口进行控制。这些集成的高性能特性，以及采用 3.3V 或 1.8 V 单电源供电的功能，使该器件非常适用于远场麦克风录音应用中空间受限的音频系统。

PCM6120-Q1 的额定工作温度范围为 -40°C 至 +125°C，并且采用 20 引脚 WQFN 封装。

器件信息

器件型号 ⁽¹⁾	封装	封装尺寸 (标称值)
PCM6120-Q1	WQFN (20)	3.00mm × 3.00mm，间距为 0.5mm

(1) 如需了解所有可用封装，请参阅数据表末尾的封装选项附录。

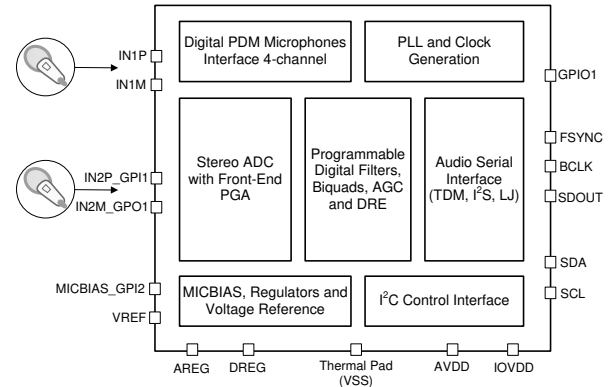

简化版方框图



Table of Contents

1 特性	1	8.1 Overview.....	20
2 应用	1	8.2 Functional Block Diagram.....	21
3 说明	1	8.3 Feature Description.....	21
4 Revision History	2	8.4 Device Functional Modes.....	61
5 Device Comparison Table	3	8.5 Programming.....	62
6 Pin Configuration and Functions	4	8.6 Register Maps.....	65
7 Specifications	5	9 Application and Implementation	103
7.1 Absolute Maximum Ratings.....	5	9.1 Application Information.....	103
7.2 ESD Ratings.....	5	9.2 Typical Applications.....	103
7.3 Recommended Operating Conditions.....	6	9.3 What to Do and What Not to Do.....	110
Thermal Information.....	6	10 Power Supply Recommendations	110
7.4 Electrical Characteristics.....	7	11 Layout	113
7.5 Timing Requirements: I ² C Interface.....	11	11.1 Layout Guidelines.....	113
7.6 Switching Characteristics: I ² C Interface.....	12	11.2 Layout Example.....	113
7.7 Timing Requirements: TDM, I ² S or LJ Interface.....	12	12 Device and Documentation Support	114
7.8 Switching Characteristics: TDM, I ² S or LJ Interface.....	12	12.1 Documentation Support.....	114
Timing Requirements: PDM Digital Microphone Interface.....	12	12.2 接收文档更新通知.....	114
7.9 Switching Characteristics: PDM Digial Microphone Interface.....	13	12.3 支持资源.....	114
7.10 Timing Diagrams.....	13	12.4 Trademarks.....	114
7.11 Typical Characteristics.....	15	12.5 Electrostatic Discharge Caution.....	114
8 Detailed Description	20	12.6 术语表.....	114
		13 Mechanical, Packaging, and Orderable Information	115
		13.1 Tape and Reel Information.....	119

4 Revision History

注：以前版本的页码可能与当前版本的页码不同

Changes from Revision * (April 2022) to Revision A (August 2022)	Page
• 将文档状态从预告信息更改为量产数据.....	1

5 Device Comparison Table

FEATURE	PCM1821-Q1	PCM1820-Q1	PCM1822-Q1	PCM3120-Q1	PCM5120-Q1	PCM6120-Q1
Control interface	Pin control			I ² C		
Digital audio serial interface	TDM or I ² S			TDM or I ² S or left-justified (LJ)		
Audio analog channel	2					
Digital microphone channel	Not available			4		
Programmable MICBIAS voltage	N/A			Yes		
Dynamic range (DRE disabled)	106 dB	113 dB	111 dB	106 dB	108 dB	113 dB
Dynamic range (DRE enabled)	Not available	123 dB	117 dB	Not available	120 dB	123 dB
ADC SNR with DRE	N/A	123 dB	117 dB	N/A	120 dB	123 dB
Input Voltage	2 V _{rms}		1 V _{rms}	2 V _{rms}		
Input Type	Differential/Single-Ended	Differential		Differential/Single-Ended		
Input impedance	10 k Ω	2.5 k Ω		2.5 k Ω , 10 k Ω , 20 k Ω		
Compatibility	Pin-to-pin, package, drop-in replacements of each other			Pin-to-pin, package, and control registers compatible; drop-in replacements of each other		
Package	WQFN (RTE), 20-pin, 3.00 mm × 3.00 mm (0.5-mm pitch)					

6 Pin Configuration and Functions



图 6-1. RTE Package, 20-Pin WQFN With Exposed Thermal Pad, Top View

表 6-1. Pin Functions

PIN		TYPE	DESCRIPTION
NO.	NAME		
1	IN1P	Analog input	Analog input 1P pin.
2	IN1M	Analog input	Analog input 1M pin.
3	IN2P_GPI1	Analog input/digital input	Analog input 2P pin or general-purpose digital input 1 (multipurpose functions such as digital microphones data, PLL input clock source, and so forth).
4	IN2M_GPO1	Analog input/digital output	Analog input 2M pin or general-purpose digital output 1 (multipurpose functions such as digital microphone clock, interrupt, and so forth).
5	VSS	Ground supply	Device ground internally shorted to thermal pad. Short this package corner pin directly to the board ground plane. See the package drawings at the end of this document for corner pin dimensions.
6	SDOUT	Digital output	Audio serial data interface bus output.
7	BCLK	Digital I/O	Audio serial data interface bus bit clock.
8	FSYNC	Digital I/O	Audio serial data interface bus frame synchronization signal.
9	IOVDD	Digital supply	Digital I/O power supply (1.8 V or 3.3 V, nominal).
10	VSS	Ground supply	Device ground internally shorted to thermal pad. Short this package corner pin directly to the board ground plane. See the package drawings at the end of this document for corner pin dimensions.
11	GPIO1	Digital I/O	General-purpose digital input/output 1 (multipurpose functions such as digital microphones clock or data, PLL input clock source, interrupt, and so forth).
12	SDA	Digital I/O	Data pin for I ² C control bus.
13	SCL	Digital input	Clock pin for I ² C control bus.
14	DREG	Digital supply	Digital regulator output voltage for digital core supply (1.5 V, nominal). Connect a 10- μ F and 0.1- μ F low ESR capacitor in parallel to device ground (VSS).
15	VSS	Ground supply	Device ground internally shorted to thermal pad. Short this package corner pin directly to the board ground plane. See the package drawings at the end of this document for corner pin dimensions.
16	AVDD	Analog supply	Analog power (1.8 V or 3.3 V, nominal).

表 6-1. Pin Functions (continued)

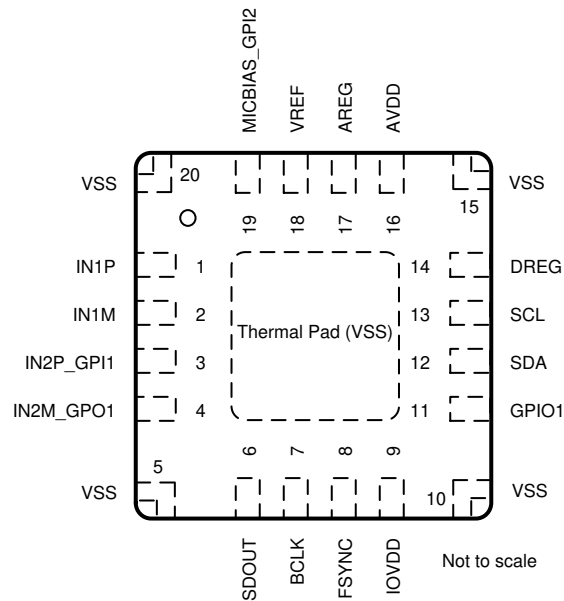
PIN		TYPE	DESCRIPTION
NO.	NAME		
17	AREG	Analog supply	Analog on-chip regulator output voltage for analog supply (1.8 V, nominal) or external analog power (1.8 V, nominal). Connect a 10- μ F and 0.1- μ F low ESR capacitor in parallel to analog ground (AVSS).
18	VREF	Analog	Analog reference voltage filter output. Connect a 1- μ F capacitor to analog ground (AVSS).
19	MICBIAS_GPI2	Analog output/digital input	MICBIAS output or general-purpose digital input 2 (multipurpose functions such as digital microphones data, PLL input clock source, and so forth). If used as MICBIAS output, then connect a 1- μ F capacitor to analog ground (AVSS).
20	VSS	Ground supply	Device ground internally shorted to thermal pad. Short this package corner pin directly to the board ground plane. See the package drawings at the end of this document for corner pin dimensions.
Thermal Pad	Thermal Pad (VSS)	Ground supply	Thermal pad shorted to internal device ground. Short the thermal pad directly to the board ground plane.

7 Specifications

7.1 Absolute Maximum Ratings

over the operating ambient temperature range (unless otherwise noted)⁽¹⁾

		MIN	MAX	UNIT
Supply voltage	AVDD to AVSS	- 0.3	3.9	V
	AREG to AVSS	- 0.3	2.0	
	IOVDD to VSS (thermal pad)	- 0.3	3.9	
Ground voltage differences	AVSS to VSS (thermal pad)	- 0.3	0.3	V
Analog input voltage	Analog input pins voltage to AVSS	- 0.3	AVDD + 0.3	V
Digital input voltage	Digital input except IN2P_GPI1 and MICBIAS_GPI2 pins voltage to VSS (thermal pad)	- 0.3	IOVDD + 0.3	V
	Digital input IN2P_GPI1 and MICBIAS_GPI2 pins voltage to VSS (thermal pad)	- 0.3	AVDD + 0.3	
Temperature	Operating ambient, T _A	- 40	125	°C
	Junction, T _J	- 40	150	
	Storage, T _{stg}	- 65	150	

- (1) Stresses beyond those listed under *Absolute Maximum Ratings* may cause permanent damage to the device. These are stress ratings only, which do not imply functional operation of the device at these or any other conditions beyond those indicated under *Recommended Operating Conditions*. Exposure to absolute-maximum-rated conditions for extended periods may affect device reliability.

7.2 ESD Ratings

		VALUE	UNIT
V _(ESD)	Electrostatic discharge	Human-body model (HBM), per ANSI/ESDA/JEDEC JS-001 ⁽¹⁾	±2000
		Charged-device model (CDM), per JEDEC specification JESD22-C101 ⁽²⁾	±500

- (1) JEDEC document JEP155 states that 500-V HBM allows safe manufacturing with a standard ESD control process.
 (2) JEDEC document JEP157 states that 250-V CDM allows safe manufacturing with a standard ESD control process.

7.3 Recommended Operating Conditions

		MIN	NOM	MAX	UNIT
POWER					
AVDD, AREG ⁽¹⁾	Analog supply voltage AVDD to AVSS (AREG is generated using onchip regulator): AVDD 3.3-V operation	3.0	3.3	3.6	V
	Analog supply voltage AVDD and AREG to AVSS (AREG internal regulator is shutdown): AVDD 1.8-V operation	1.7	1.8	1.9	
IOVDD	IO supply voltage to VSS (thermal pad): IOVDD 3.3-V operation	3.0	3.3	3.6	V
	IO supply voltage to VSS (thermal pad): IOVDD 1.8-V operation	1.65	1.8	1.95	
INPUTS					
	Analog input pins voltage to AVSS	0		AVDD	V
	Digital input except IN2P_GPI1 and MICBIAS_GPI2 pins voltage to VSS (thermal pad)	0		IOVDD	V
	Digital input IN2P_GPI1 and MICBIAS_GPI2 pins voltage to VSS (thermal pad)	0		AVDD	V
TEMPERATURE					
T _A	Operating ambient temperature	-40		125	°C
OTHERS					
	GPIOx or GPIx (used as MCLK input) clock frequency			36.864	MHz
C _b	SCL and SDA bus capacitance for I ² C interface supports standard-mode and fast-mode			400	pF
	SCL and SDA bus capacitance for I ² C interface supports fast-mode plus			550	
C _L	Digital output load capacitance		20	50	pF

(1) AVSS and VSS (thermal pad): all ground pins must be tied together and must not differ in voltage by more than 0.2 V.

Thermal Information

THERMAL METRIC ⁽¹⁾		PCM6120-Q1	UNIT
		RTE (WQFN)	
		20 PINS	
R _{θJA}	Junction-to-ambient thermal resistance	55.9	°C/W
R _{θJC(top)}	Junction-to-case (top) thermal resistance	33.1	°C/W
R _{θJB}	Junction-to-board thermal resistance	23.4	°C/W
ψ _{JT}	Junction-to-top characterization parameter	0.6	°C/W
ψ _{JB}	Junction-to-board characterization parameter	23.3	°C/W
R _{θJC(bot)}	Junction-to-case (bottom) thermal resistance	16.7	°C/W

(1) For more information about traditional and new thermal metrics, see the [Semiconductor and IC Package Thermal Metrics](#) application report.

7.4 Electrical Characteristics

at $T_A = 25^\circ\text{C}$, $AVDD = 3.3\text{ V}$, $IOVDD = 3.3\text{ V}$, $f_{IN} = 1\text{-kHz}$ sinusoidal signal, $f_S = 48\text{ kHz}$, 32-bit audio data, $BCLK = 256 \times f_S$, TDM slave mode, and PLL on (unless otherwise noted)

PARAMETER		TEST CONDITIONS	MIN	TYP	MAX	UNIT
ADC CONFIGURATION						
	AC input impedance	Input pins INxP or INxM, 2.5-k Ω input impedance selection		2.5		k Ω
		Input pins INxP or INxM, 10-k Ω input impedance selection		10		
		Input pins INxP or INxM, 20-k Ω input impedance selection		20		
	Channel gain range	Programmable range with 0.5-dB steps	0		42	dB
ADC PERFORMANCE FOR LINE/MICROPHONE INPUT RECORDING : AVDD 3.3-V OPERATION						
	Differential input full-scale AC signal voltage	AC-coupled input		2		V_{RMS}
	Single-ended input full-scale AC signal voltage	AC-coupled input		1		V_{RMS}
SNR	Signal-to-noise ratio, A-weighted ^{(1) (2)}	IN1 differential input selected and AC signal shorted to ground, DRE enabled (DRE_LVL = -36 dB, DRE_MAXGAIN = 24 dB), 2.5-k Ω input impedance selection	115	122		dB
		IN1 differential input selected and AC signal shorted to ground, DRE enabled (DRE_LVL = -36 dB, DRE_MAXGAIN = 24 dB), 10-k Ω input impedance selection		117		
		IN1 differential input selected and AC signal shorted to ground, DRE disabled, 2.5-k Ω input impedance selection, 0-dB channel gain	106	112		
		IN1 differential input selected and AC signal shorted to ground, DRE disabled, 2.5-k Ω input impedance selection, 12-dB channel gain		108		
DR	Dynamic range, A-weighted ⁽²⁾	IN1 differential input selected and -60-dB full-scale AC signal input, DRE enabled (DRE_LVL = -36 dB, DRE_MAXGAIN = 24 dB), 2.5-k Ω input impedance selection		123		dB
		IN1 differential input selected and -60-dB full-scale AC signal input, DRE enabled (DRE_LVL = -36 dB, DRE_MAXGAIN = 24 dB), 10-k Ω input impedance selection		118		
		IN1 differential input selected and -60-dB full-scale AC signal input, DRE disabled, 2.5-k Ω input impedance selection, 0-dB channel gain		113		
		IN1 differential input selected and -72-dB full-scale AC signal input, DRE disabled, 2.5-k Ω input impedance selection, 12-dB channel gain		108		
THD+N	Total harmonic distortion ^{(2) (3)}	IN1 differential input selected and -1-dB full-scale AC signal input, DRE enabled (DRE_LVL = -36 dB, DRE_MAXGAIN = 24 dB), 2.5-k Ω input impedance selection		-95	-80	dB
		IN1 differential input selected and -1-dB full-scale AC signal input, DRE enabled (DRE_LVL = -36 dB, DRE_MAXGAIN = 24 dB), 10-k Ω input impedance selection		-95		
		IN1 differential input selected and -1-dB full-scale AC signal input, DRE disabled, 2.5-k Ω input impedance selection, 0-dB channel gain		-95		
		IN1 differential input selected and -13-dB full-scale AC signal input, DRE disabled, 2.5-k Ω input impedance selection, 12-dB channel gain		-93		
ADC PERFORMANCE FOR LINE/MICROPHONE INPUT RECORDING : AVDD 1.8-V OPERATION						
	Differential input full-scale AC signal voltage	AC-coupled Input		1		V_{RMS}

at $T_A = 25^\circ\text{C}$, $AVDD = 3.3\text{ V}$, $IOVDD = 3.3\text{ V}$, $f_{IN} = 1\text{-kHz}$ sinusoidal signal, $f_S = 48\text{ kHz}$, 32-bit audio data, $BCLK = 256 \times f_S$, TDM slave mode, and PLL on (unless otherwise noted)

PARAMETER		TEST CONDITIONS	MIN	TYP	MAX	UNIT
	Single-ended input full-scale AC signal voltage	AC-coupled Input		0.5		V_{RMS}
SNR	Signal-to-noise ratio, A-weighted ^{(1) (2)}	IN1 differential input selected and AC signal shorted to ground, DRE enabled (DRE_LVL = -36 dB, DRE_MAXGAIN = 24 dB), 2.5-k Ω input impedance selection		116		dB
		IN1 differential input selected and AC signal shorted to ground, DRE enabled (DRE_LVL = -36 dB, DRE_MAXGAIN = 24 dB), 10-k Ω input impedance selection		111		
		IN1 differential input selected and AC signal shorted to ground, DRE disabled, 2.5-k Ω input impedance selection, 0-dB channel gain		105		
DR	Dynamic range, A-weighted ⁽²⁾	IN1 differential input selected and -60-dB full-scale AC signal input, DRE enabled (DRE_LVL = -36 dB, DRE_MAXGAIN = 24 dB), 2.5-k Ω input impedance selection		117		dB
		IN1 differential input selected and -60-dB full-scale AC signal input, DRE enabled (DRE_LVL = -36 dB, DRE_MAXGAIN = 24 dB), 10-k Ω input impedance selection		112		
		IN1 differential input selected and -60-dB full-scale AC signal input, DRE disabled, 2.5-k Ω input impedance selection, 0-dB channel gain		106		
THD+N	Total harmonic distortion ^{(2) (3)}	IN1 differential input selected and -2-dB full-scale AC signal input, DRE enabled (DRE_LVL = -36 dB, DRE_MAXGAIN = 24 dB), 2.5-k Ω input impedance selection		-90		dB
		IN1 differential input selected and -2-dB full-scale AC signal input, DRE enabled (DRE_LVL = -36 dB, DRE_MAXGAIN = 24 dB), 10-k Ω input impedance selection		-90		
		IN1 differential input selected and -2-dB full-scale AC signal input, DRE disabled, 2.5-k Ω input impedance selection, 0 dB channel gain		-90		
ADC OTHER PARAMETERS						
	Digital volume control range	Programmable 0.5-dB steps	-100		27	dB
	Output data sample rate	Programmable	7.35		768	kHz
	Output data sample word length	Programmable	16		32	Bits
	Digital high-pass filter cutoff frequency	First-order IIR filter with programmable coefficients, -3-dB point (default setting)		12		Hz
	Interchannel isolation	-1-dB full-scale AC-signal input to non measurement channel		-124		dB
	Interchannel gain mismatch	-6-dB full-scale AC-signal input and 0-dB channel gain		0.1		dB
	Gain drift ⁽⁴⁾	0-dB channel gain, across temperature range -40°C to 125°C		36.8		ppm/°C
	Interchannel phase mismatch	1-kHz sinusoidal signal		0.02		Degrees
	Phase drift ⁽⁵⁾	1-kHz sinusoidal signal, across temperature range -40°C to 125°C		0.0005		Degrees/°C
PSRR	Power-supply rejection ratio	100-mV _{pp} , 1-kHz sinusoidal signal on AVDD, differential input selected, 0-dB channel gain		102		dB
CMRR	Common-mode rejection ratio	Differential microphone input selected, 0-dB channel gain, 100-mV _{pp} , 1-kHz signal on both pins and measure level at output in high CMRR Mode		80		dB
MICROPHONE BIAS						
	MICBIAS noise	BW = 20 Hz to 20 kHz, A-weighted, 1- μF capacitor between MICBIAS and AVSS		2.1		μV_{RMS}

at $T_A = 25^\circ\text{C}$, $AVDD = 3.3\text{ V}$, $IOVDD = 3.3\text{ V}$, $f_{IN} = 1\text{-kHz}$ sinusoidal signal, $f_S = 48\text{ kHz}$, 32-bit audio data, $BCLK = 256 \times f_S$, TDM slave mode, and PLL on (unless otherwise noted)

PARAMETER		TEST CONDITIONS	MIN	TYP	MAX	UNIT
MICBIAS voltage		MICBIAS programmed to VREF and VREF programmed to either 2.75 V, 2.5 V, or 1.375 V	VREF		V	
		MICBIAS programmed to $VREF \times 1.096$ and VREF programmed to either 2.75 V, 2.5 V, or 1.375 V	$VREF \times 1.096$			
		Bypass to AVDD with 5-mA load	AVDD - 0.2			
MICBIAS current drive					5	mA
MICBIAS load regulation		MICBIAS programmed to either VREF or $VREF \times 1.096$, measured up to max load	0	0.6	1	%
MICBIAS over current protection threshold			6.1			mA
DIGITAL I/O						
V_{IL}	Low-level digital input logic voltage threshold	All digital pins except IN2P_GPI1 and MICBIAS_GPI2, SDA and SCL, IOVDD 1.8-V operation	- 0.3		$0.35 \times IOVDD$	V
		All digital pins except IN2P_GPI1 and MICBIAS_GPI2, SDA and SCL, IOVDD 3.3-V operation	- 0.3		0.8	
V_{IH}	High-level digital input logic voltage threshold	All digital pins except IN2P_GPI1 and MICBIAS_GPI2, SDA and SCL, IOVDD 1.8-V operation	$0.65 \times IOVDD$		$IOVDD + 0.3$	V
		All digital pins except IN2P_GPI1 and MICBIAS_GPI2, SDA and SCL, IOVDD 3.3-V operation	2		$IOVDD + 0.3$	
V_{OL}	Low-level digital output voltage	All digital pins except IN2M_GPO1, SDA and SCL, $I_{OL} = -2\text{ mA}$, IOVDD 1.8-V operation			0.45	V
		All digital pins except IN2M_GPO1, SDA and SCL, $I_{OL} = -2\text{ mA}$, IOVDD 3.3-V operation			0.4	
V_{OH}	High-level digital output voltage	All digital pins except IN2M_GPO1, SDA and SCL, $I_{OH} = 2\text{ mA}$, IOVDD 1.8-V operation	$IOVDD - 0.45$			V
		All digital pins except IN2M_GPO1, SDA and SCL, $I_{OH} = 2\text{ mA}$, IOVDD 3.3-V operation	2.4			
$V_{IL(I2C)}$	Low-level digital input logic voltage threshold	SDA and SCL	- 0.5		$0.3 \times IOVDD$	V
$V_{IH(I2C)}$	High-level digital input logic voltage threshold	SDA and SCL	$0.7 \times IOVDD$		$IOVDD + 0.5$	V
$V_{OL1(I2C)}$	Low-level digital output voltage	SDA, $I_{OL(I2C)} = -3\text{ mA}$, $IOVDD > 2\text{ V}$			0.4	V
$V_{OL2(I2C)}$	Low-level digital output voltage	SDA, $I_{OL(I2C)} = -2\text{ mA}$, $IOVDD \leq 2\text{ V}$			$0.2 \times IOVDD$	V
$I_{OL(I2C)}$	Low-level digital output current	SDA, $V_{OL(I2C)} = 0.4\text{ V}$, standard-mode or fast-mode	3			mA
		SDA, $V_{OL(I2C)} = 0.4\text{ V}$, fast-mode plus	20			
I_{IH}	Input logic-high leakage for digital inputs	All digital pins except IN2P_GPI1 and MICBIAS_GPI2 pins, input = IOVDD	- 5	0.1	5	μA
I_{IL}	Input logic-low leakage for digital inputs	All digital pins except IN2P_GPI1 and MICBIAS_GPI2 pins, input = 0 V	- 5	0.1	5	μA
$V_{IL(GPIx)}$	Low-level digital input logic voltage threshold	IN2P_GPI1 and MICBIAS_GPI2 digital pins, AVDD 1.8-V operation	- 0.3		$0.35 \times AVDD$	V
		IN2P_GPI1 and MICBIAS_GPI2 digital pins, AVDD 3.3-V operation	- 0.3		0.8	
$V_{IH(GPIx)}$	High-level digital input logic voltage threshold	IN2P_GPI1 and MICBIAS_GPI2 digital pins, AVDD 1.8-V operation	$0.65 \times AVDD$		$AVDD + 0.3$	V
		IN2P_GPI1 and MICBIAS_GPI2 digital pins, AVDD 3.3-V operation	2		$AVDD + 0.3$	
$V_{OL(GPOx)}$	Low-level digital output voltage	IN2M_GPO2 digital pin, $I_{OL} = -2\text{ mA}$, AVDD 1.8-V operation			0.45	V
		IN2M_GPO2 digital pin, $I_{OL} = -2\text{ mA}$, AVDD 3.3-V operation			0.4	
$V_{OH(GPOx)}$	High-level digital output voltage	IN2M_GPO2 digital pin, $I_{OH} = 2\text{ mA}$, AVDD 1.8-V operation	$AVDD - 0.45$			V
		IN2M_GPO2 digital pin, $I_{OH} = 2\text{ mA}$, AVDD 3.3-V operation	2.4			

at $T_A = 25^\circ\text{C}$, $AVDD = 3.3\text{ V}$, $IOVDD = 3.3\text{ V}$, $f_{IN} = 1\text{-kHz}$ sinusoidal signal, $f_S = 48\text{ kHz}$, 32-bit audio data, $BCLK = 256 \times f_S$, TDM slave mode, and PLL on (unless otherwise noted)

PARAMETER		TEST CONDITIONS	MIN	TYP	MAX	UNIT
$I_{IH(GPIx)}$	Input logic-high leakage for digital inputs	IN2P_GPI1 and MICBIAS_GPI2 digital pins, input = $AVDD$	- 5	0.1	5	μA
$I_{IL(GPIx)}$	Input logic-high leakage for digital inputs	IN2P_GPI1 and MICBIAS_GPI2 digital pins, input = 0 V	- 5	0.1	5	μA
C_{IN}	Input capacitance for digital inputs	All digital pins		5		pF
R_{PD}	Pulldown resistance for digital I/O pins when asserted on			20		k Ω

TYPICAL SUPPLY CURRENT CONSUMPTION

I_{AVDD}		All external clocks stopped, $AVDD = 3.3\text{ V}$, internal AREG		5		μA
I_{AVDD}	Current consumption in sleep mode (software shutdown mode)	All external clocks stopped, $AVDD = 1.8\text{ V}$, external AREG supply (AREG shorted to $AVDD$)		29		
I_{IOVDD}		All external clocks stopped, $IOVDD = 3.3\text{ V}$		0.5		
I_{IOVDD}		All external clocks stopped, $IOVDD = 1.8\text{ V}$		0.5		
I_{AVDD}		Current consumption with ADC 2-channel operating at $f_S 48\text{-kHz}$, PLL off, $BCLK = 512 \times f_S$ and DRE disable	$AVDD = 3.3\text{ V}$, internal AREG		11.3	
I_{AVDD}	$AVDD = 1.8\text{ V}$, external AREG supply (AREG shorted to $AVDD$)			10.6		
I_{IOVDD}	$IOVDD = 3.3\text{ V}$			0.1		
I_{IOVDD}	$IOVDD = 1.8\text{ V}$			0.05		
I_{AVDD}	Current consumption with ADC 2-channel operating at $f_S 16\text{-kHz}$, PLL on, $BCLK = 256 \times f_S$ and DRE disable	$AVDD = 3.3\text{ V}$, internal AREG		11.5		mA
I_{AVDD}		$AVDD = 1.8\text{ V}$, external AREG supply (AREG shorted to $AVDD$)		10.8		
I_{IOVDD}		$IOVDD = 3.3\text{ V}$		0.05		
I_{IOVDD}		$IOVDD = 1.8\text{ V}$		0.02		
I_{AVDD}	Current consumption with ADC 2-channel operating at $f_S 48\text{-kHz}$, PLL on, $BCLK = 256 \times f_S$ and DRE disable	$AVDD = 3.3\text{ V}$, internal AREG		12.4		mA
I_{AVDD}		$AVDD = 1.8\text{ V}$, external AREG supply (AREG shorted to $AVDD$)		11.7		
I_{IOVDD}		$IOVDD = 3.3\text{ V}$		0.1		
I_{IOVDD}		$IOVDD = 1.8\text{ V}$		0.05		
I_{AVDD}	Current consumption with ADC 2-channel operating at $f_S 48\text{-kHz}$, PLL on, $BCLK = 256 \times f_S$ and DRE enable	$AVDD = 3.3\text{ V}$, internal AREG		13.8		mA
I_{AVDD}		$AVDD = 1.8\text{ V}$, external AREG supply (AREG shorted to $AVDD$)		13.1		
I_{IOVDD}		$IOVDD = 3.3\text{ V}$		0.1		
I_{IOVDD}		$IOVDD = 1.8\text{ V}$		0.05		

- (1) Ratio of output level with 1-kHz full-scale sine-wave input, to the output level with the AC signal input shorted to ground, measured A-weighted over a 20-Hz to 20-kHz bandwidth using an audio analyzer.
- (2) All performance measurements done with 20-kHz low-pass filter and, where noted, A-weighted filter. Failure to use such a filter may result in higher THD and lower SNR and dynamic range readings than shown in the Electrical Characteristics. The low-pass filter removes out-of-band noise, which, although not audible, may affect dynamic specification values.
- (3) For best distortion performance, use input AC-coupling capacitors with low-voltage coefficient.
- (4) Gain drift = gain variation (in temperature range) / typical gain value (gain at room temperature) / temperature range $\times 10^6$ measured with gain in linear scale.
- (5) Phase drift = phase deviation (in temperature range) / (temperature range).

7.5 Timing Requirements: I²C Interface

at T_A = 25°C, IOVDD = 3.3 V or 1.8 V (unless otherwise noted); see [Figure 7-1](#) for timing diagram

		MIN	NOM	MAX	UNIT
STANDARD-MODE					
f _{SCL}	SCL clock frequency	0		100	kHz
t _{HD,STA}	Hold time (repeated) START condition. After this period, the first clock pulse is generated.	4			μs
t _{LOW}	Low period of the SCL clock	4.7			μs
t _{HIGH}	High period of the SCL clock	4			μs
t _{SU,STA}	Setup time for a repeated START condition	4.7			μs
t _{HD,DAT}	Data hold time	0		3.45	μs
t _{SU,DAT}	Data setup time	250			ns
t _r	SDA and SCL rise time			1000	ns
t _f	SDA and SCL fall time			300	ns
t _{SU,STO}	Setup time for STOP condition	4			μs
t _{BUF}	Bus free time between a STOP and START condition	4.7			μs
FAST-MODE					
f _{SCL}	SCL clock frequency	0		400	kHz
t _{HD,STA}	Hold time (repeated) START condition. After this period, the first clock pulse is generated.	0.6			μs
t _{LOW}	Low period of the SCL clock	1.3			μs
t _{HIGH}	High period of the SCL clock	0.6			μs
t _{SU,STA}	Setup time for a repeated START condition	0.6			μs
t _{HD,DAT}	Data hold time	0		0.9	μs
t _{SU,DAT}	Data setup time	100			ns
t _r	SDA and SCL rise time	20		300	ns
t _f	SDA and SCL fall time		20 × (IOVDD / 5.5 V)	300	ns
t _{SU,STO}	Setup time for STOP condition	0.6			μs
t _{BUF}	Bus free time between a STOP and START condition	1.3			μs
FAST-MODE PLUS					
f _{SCL}	SCL clock frequency	0		1000	kHz
t _{HD,STA}	Hold time (repeated) START condition. After this period, the first clock pulse is generated.	0.26			μs
t _{LOW}	Low period of the SCL clock	0.5			μs
t _{HIGH}	High period of the SCL clock	0.26			μs
t _{SU,STA}	Setup time for a repeated START condition	0.26			μs
t _{HD,DAT}	Data hold time	0			μs
t _{SU,DAT}	Data setup time	50			ns
t _r	SDA and SCL rise time			120	ns
t _f	SDA and SCL fall time		20 × (IOVDD / 5.5 V)	120	ns
t _{SU,STO}	Setup time for STOP condition	0.26			μs
t _{BUF}	Bus free time between a STOP and START condition	0.5			μs

7.6 Switching Characteristics: I²C Interface

at T_A = 25°C, IOVDD = 3.3 V or 1.8 V (unless otherwise noted); see [Figure 7-1](#) for timing diagram

PARAMETER		TEST CONDITIONS	MIN	TYP	MAX	UNIT
t _d (SDA)	SCL to SDA delay	Standard-mode	250		1250	ns
		Fast-mode	250		850	
		Fast-mode plus			400	

7.7 Timing Requirements: TDM, I²S or LJ Interface

at T_A = 25°C, IOVDD = 3.3 V or 1.8 V and 20-pF load on all outputs (unless otherwise noted); see [Figure 7-2](#) for timing diagram

PARAMETER		TEST CONDITIONS	MIN	NOM	MAX	UNIT
t _(BCLK)	BCLK period		40			ns
t _H (BCLK)	BCLK high pulse duration ⁽¹⁾		25			ns
t _L (BCLK)	BCLK low pulse duration ⁽¹⁾		25			ns
t _{SU} (FSYNC)	FSYNC setup time		8			ns
t _{HLD} (FSYNC)	FSYNC hold time		8			ns
t _r (BCLK)	BCLK rise time	10% - 90% rise time ⁽²⁾			10	ns
t _f (BCLK)	BCLK fall time	90% - 10% fall time ⁽²⁾			10	ns

- (1) The BCLK minimum high or low pulse duration can be relaxed to 14 ns (to meet the timing specifications), if the SDOUT data line is latched on the same BCLK edge polarity as the edge used by the device to transmit SDOUT data.
- (2) The BCLK maximum rise and fall time can be relaxed to 13 ns if the BCLK frequency used in the system is below 20 MHz. Relaxing the BCLK rise and fall time can cause noise to increase because of higher clock jitter.

7.8 Switching Characteristics: TDM, I²S or LJ Interface

at T_A = 25°C, IOVDD = 3.3 V or 1.8 V and 20-pF load on all outputs (unless otherwise noted); see [Figure 7-2](#) for timing diagram

PARAMETER		TEST CONDITIONS	MIN	TYP	MAX	UNIT
t _d (SDOUT-BCLK)	BCLK to SDOUT delay	50% of BCLK to 50% of SDOUT	3		18	ns
t _d (SDOUT-FSYNC)	FSYNC to SDOUT delay in TDM or LJ mode (for MSB data with TX_OFFSET = 0)	50% of FSYNC to 50% of SDOUT			18	ns
f _(BCLK)	BCLK output clock frequency: master mode ⁽¹⁾				24.576	MHz
t _H (BCLK)	BCLK high pulse duration: master mode		14			ns
t _L (BCLK)	BCLK low pulse duration: master mode		14			ns
t _d (FSYNC)	BCLK to FSYNC delay: master mode	50% of BCLK to 50% of FSYNC	3		18	ns
t _r (BCLK)	BCLK rise time: master mode	10% - 90% rise time			8	ns
t _f (BCLK)	BCLK fall time: master mode	90% - 10% fall time			8	ns

- (1) The BCLK output clock frequency must be lower than 18.5 MHz (to meet the timing specifications), if the SDOUT data line is latched on the opposite BCLK edge polarity than the edge used by the device to transmit SDOUT data.

Timing Requirements: PDM Digital Microphone Interface

at T_A = 25°C, IOVDD = 3.3 V or 1.8 V and 20-pF load on all outputs (unless otherwise noted); see [Figure 7-3](#) for timing diagram

PARAMETER		TEST CONDITIONS	MIN	NOM	MAX	UNIT
t _{SU} (PDMINx)	PDMINx setup time		30			ns
t _{HLD} (PDMINx)	PDMINx hold time		0			ns

7.9 Switching Characteristics: PDM Digital Microphone Interface

at $T_A = 25^\circ\text{C}$, IOVDD = 3.3 V or 1.8 V and 20-pF load on all outputs (unless otherwise noted); see Figure 7-3 for timing diagram

PARAMETER	TEST CONDITIONS	MIN	TYP	MAX	UNIT
f_{PDMCLK}	PDMCLK clock frequency	0.768		6.144	MHz
$t_{\text{H(PDMCLK)}}$	PDMCLK high pulse duration	72			ns
$t_{\text{L(PDMCLK)}}$	PDMCLK low pulse duration	72			ns
$t_{\text{r(PDMCLK)}}$	PDMCLK rise time	10% - 90% rise time		18	ns
$t_{\text{f(PDMCLK)}}$	PDMCLK fall time	90% - 10% fall time		18	ns

7.10 Timing Diagrams



图 7-1. I²C Interface Timing Diagram



图 7-2. TDM (With BCLK_POL = 1), I²S, and LJ Interface Timing Diagram

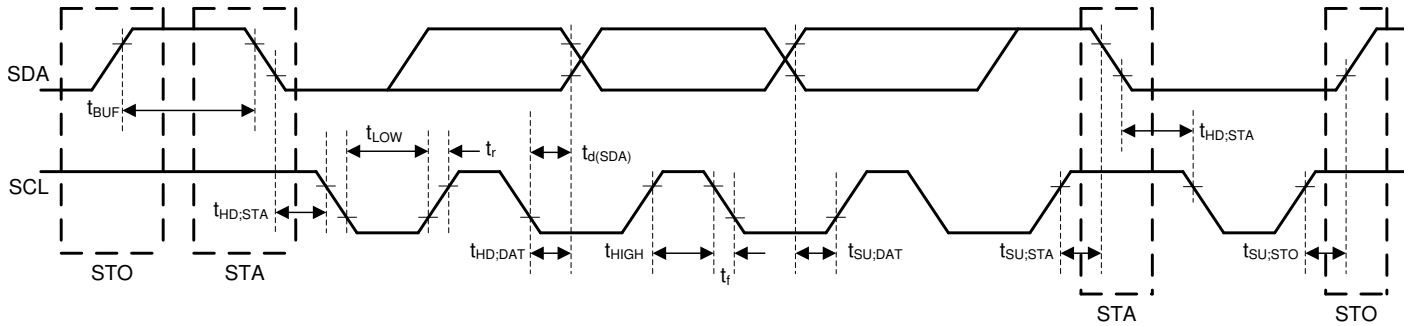

图 7-3. PDM Digital Microphone Interface Timing Diagram

7.11 Typical Characteristics

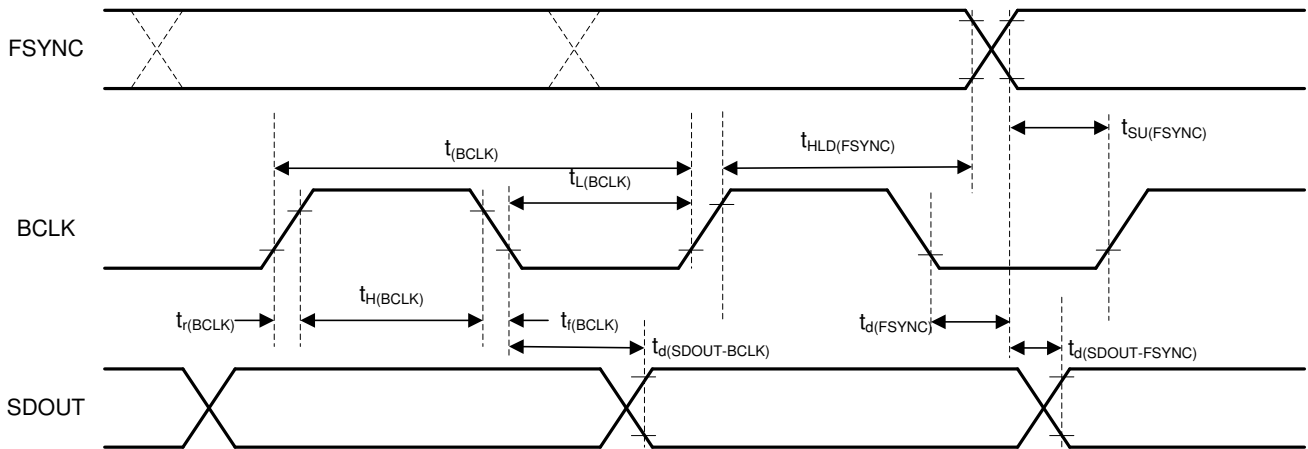
at $T_A = 25^\circ\text{C}$, $AVDD = 3.3\text{ V}$, $IOVDD = 3.3\text{ V}$, $f_{IN} = 1\text{-kHz}$ sinusoidal signal, $f_S = 48\text{ kHz}$, 32-bit audio data, $BCLK = 256 \times f_S$, TDM slave mode, PLL on, $DRE_LVL = -36\text{ dB}$, channel gain = 0 dB, and linear phase decimation filter (unless otherwise noted); all performance measurements are done with a 20-kHz, low-pass filter, and an A-weighted filter

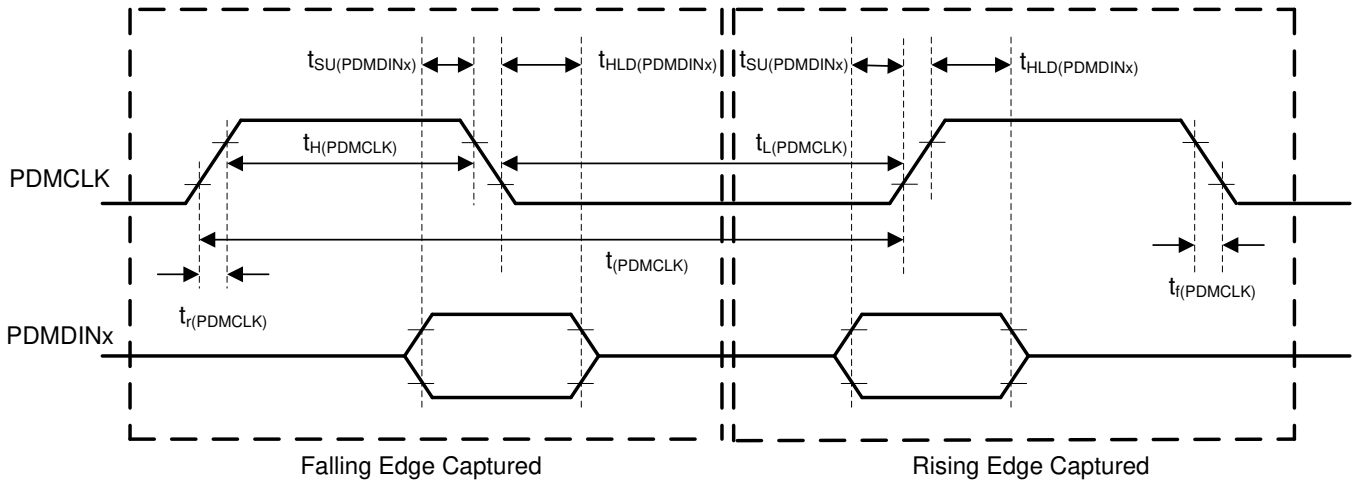

图 7-4. THD+N vs Input Amplitude With DRE Enabled



图 7-5. THD+N vs Input Amplitude With DRE Disabled

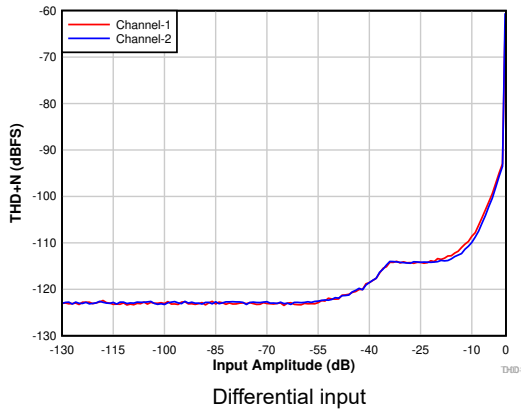

图 7-6. THD+N vs Input Amplitude With DRE Enabled

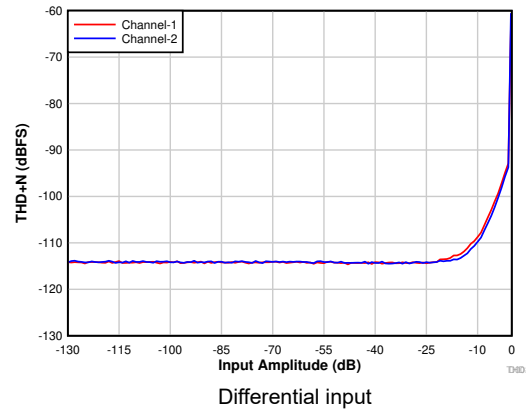

图 7-7. THD+N vs Input Amplitude With DRE Disabled

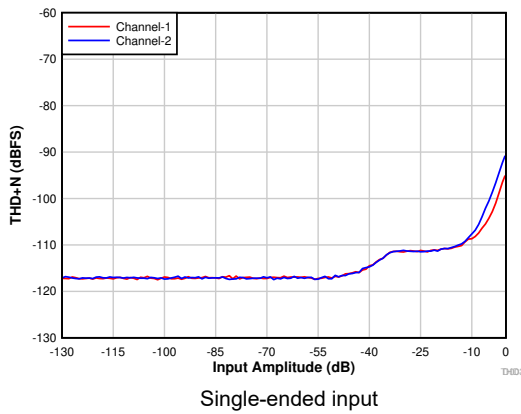

图 7-8. THD+N vs Input Amplitude With DRE Enabled

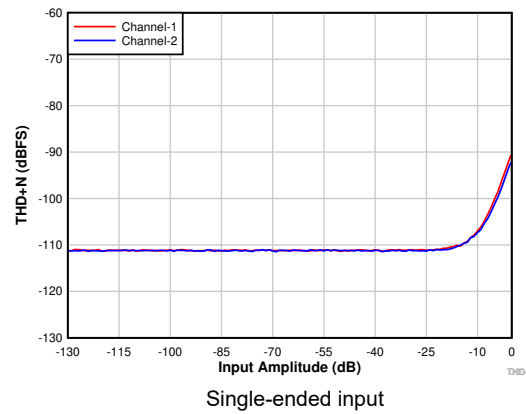

图 7-9. THD+N vs Input Amplitude With DRE Disabled

7.11 Typical Characteristics (continued)

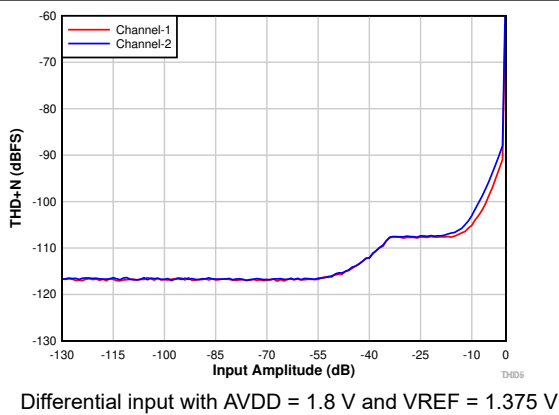
at $T_A = 25^\circ\text{C}$, $AVDD = 3.3\text{ V}$, $IOVDD = 3.3\text{ V}$, $f_{IN} = 1\text{-kHz}$ sinusoidal signal, $f_S = 48\text{ kHz}$, 32-bit audio data, $BCLK = 256 \times f_S$, TDM slave mode, PLL on, $DRE_LVL = -36\text{ dB}$, channel gain = 0 dB , and linear phase decimation filter (unless otherwise noted); all performance measurements are done with a 20-kHz, low-pass filter, and an A-weighted filter

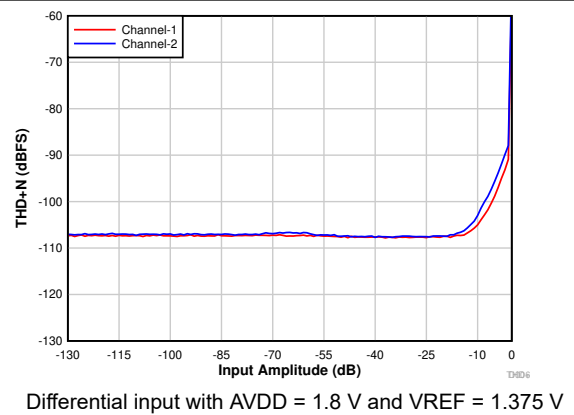

图 7-10. THD+N vs Input Frequency at -60-dBr Input With DRE Enabled



图 7-11. THD+N vs Input Frequency at -60-dBr Input With DRE Disabled

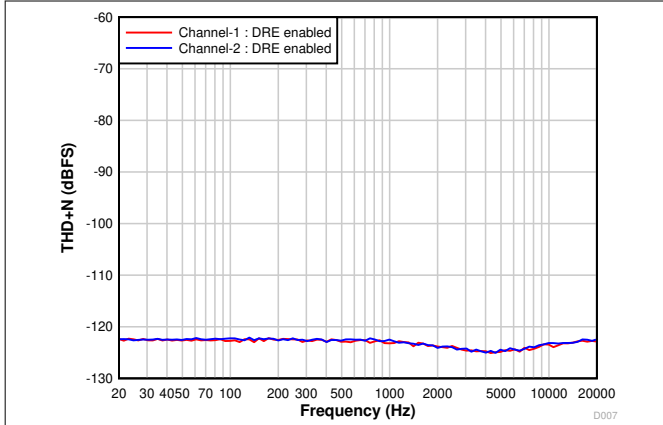

图 7-12. THD+N vs Input Frequency at -1-dBr Input With DRE Disabled

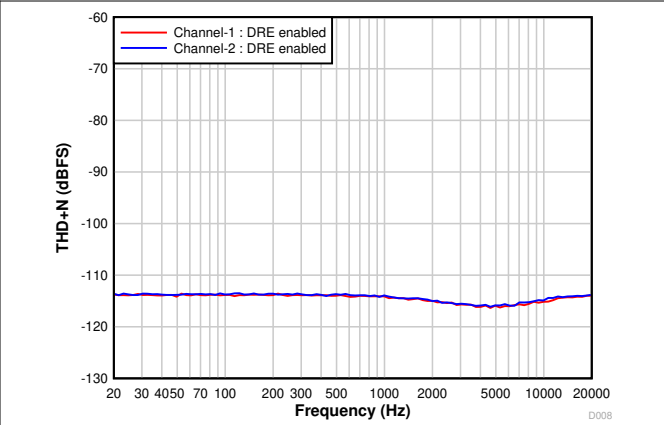

图 7-13. Input-Referred Noise vs Channel Gain

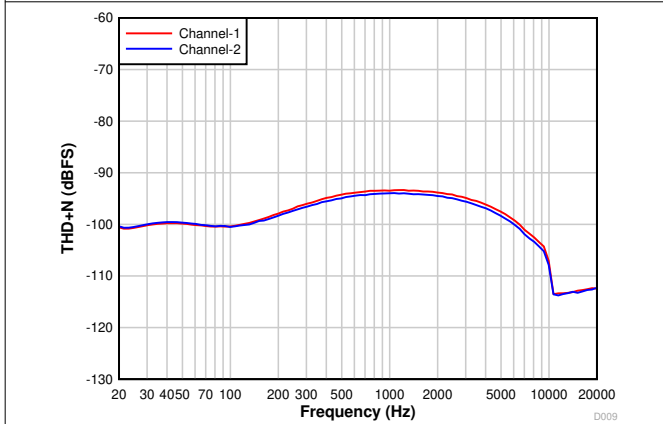

图 7-14. Input-Referred Noise vs Channel Gain

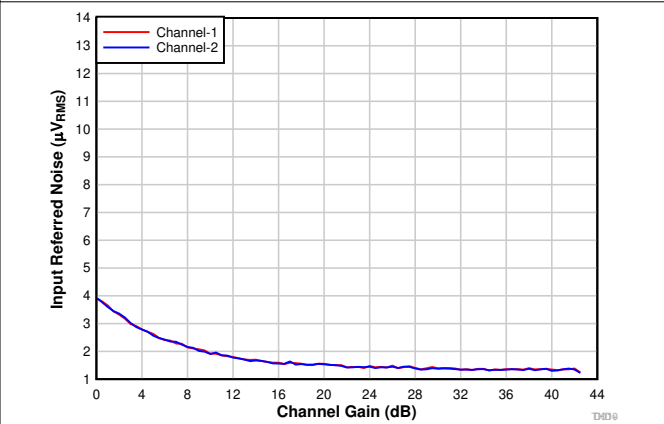

图 7-15. Frequency Response With a -12-dBr Input

7.11 Typical Characteristics (continued)

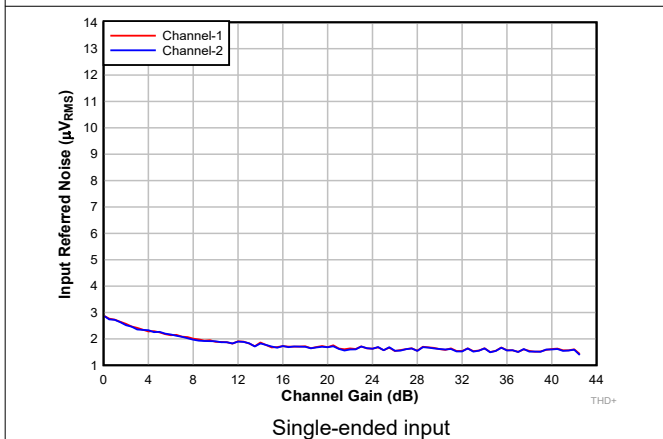
at $T_A = 25^\circ\text{C}$, $AVDD = 3.3\text{ V}$, $IOVDD = 3.3\text{ V}$, $f_{IN} = 1\text{-kHz}$ sinusoidal signal, $f_S = 48\text{ kHz}$, 32-bit audio data, $BCLK = 256 \times f_S$, TDM slave mode, PLL on, $DRE_LVL = -36\text{ dB}$, channel gain = 0 dB , and linear phase decimation filter (unless otherwise noted); all performance measurements are done with a 20-kHz, low-pass filter, and an A-weighted filter

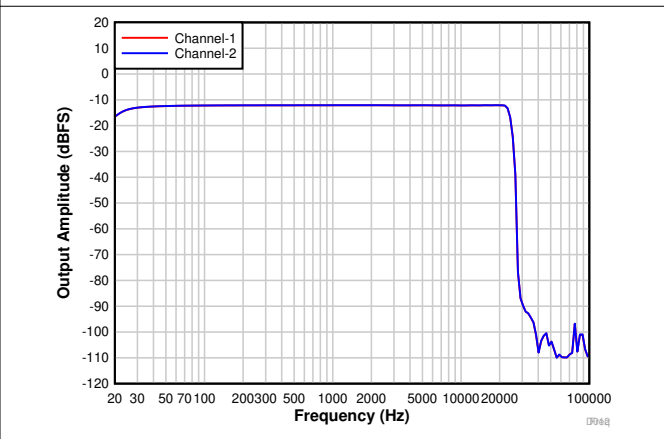

图 7-16. Power-Supply Rejection Ratio vs Ripple Frequency With 100-mV_{pp} Amplitude



图 7-17. Differential FFT With Idle Input With DRE Enabled

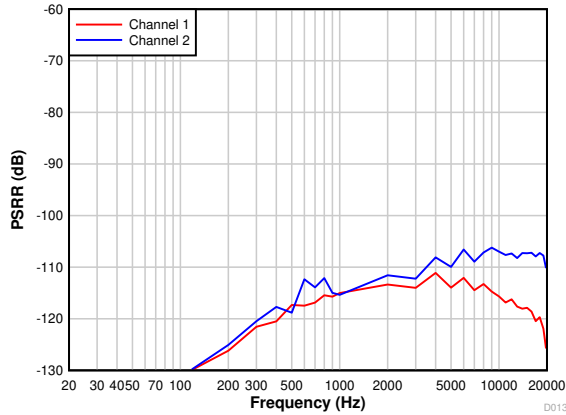

图 7-18. Differential FFT With Idle Input With DRE Disabled

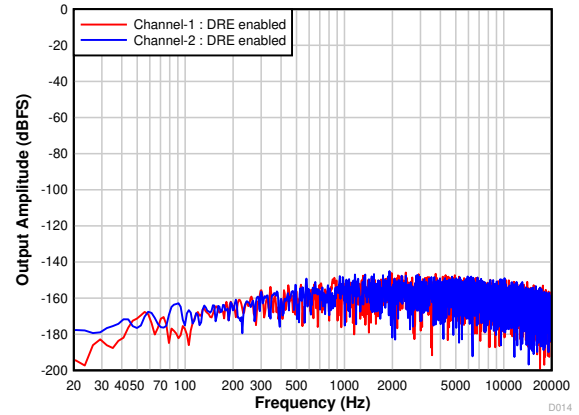

图 7-19. Differential FFT With a -60-dBr Input With DRE Enabled

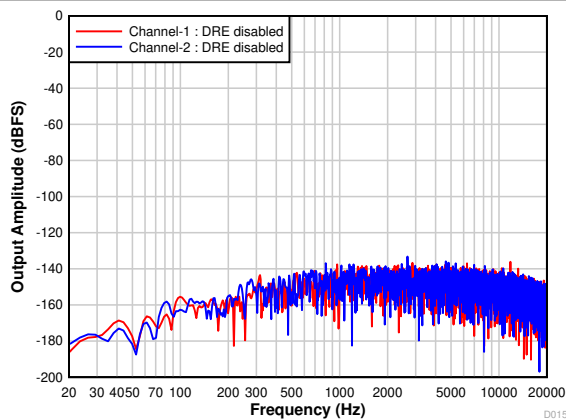

图 7-20. Differential FFT With a -60-dBr Input With DRE Disabled

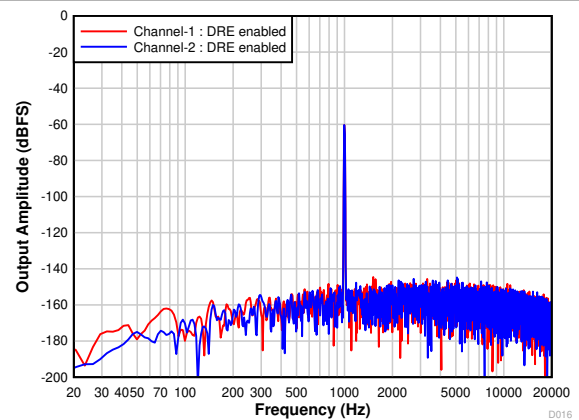

图 7-21. Single Ended FFT With Idle Input With DRE Enabled

7.11 Typical Characteristics (continued)

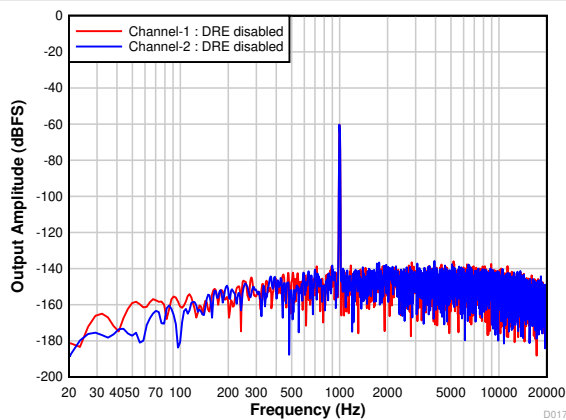
at $T_A = 25^\circ\text{C}$, $AVDD = 3.3\text{ V}$, $IOVDD = 3.3\text{ V}$, $f_{IN} = 1\text{-kHz}$ sinusoidal signal, $f_S = 48\text{ kHz}$, 32-bit audio data, $BCLK = 256 \times f_S$, TDM slave mode, PLL on, $DRE_LVL = -36\text{ dB}$, channel gain = 0 dB, and linear phase decimation filter (unless otherwise noted); all performance measurements are done with a 20-kHz, low-pass filter, and an A-weighted filter

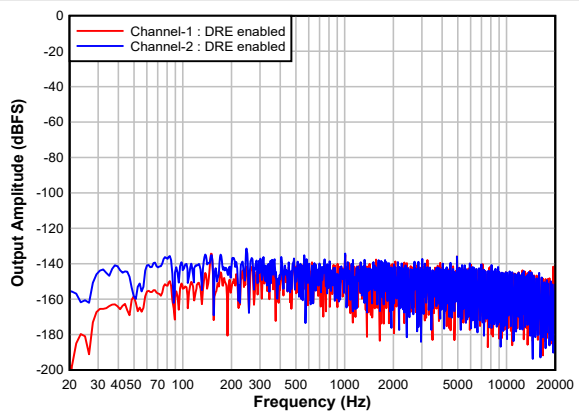

图 7-22. Single Ended FFT With Idle Input With DRE Disabled



图 7-23. Single Ended FFT With a -60-dBr Input With DRE Enabled

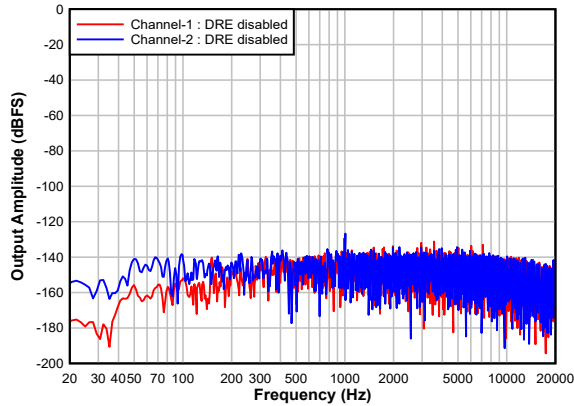

图 7-24. Single Ended FFT With a -60-dBr Input With DRE Disabled

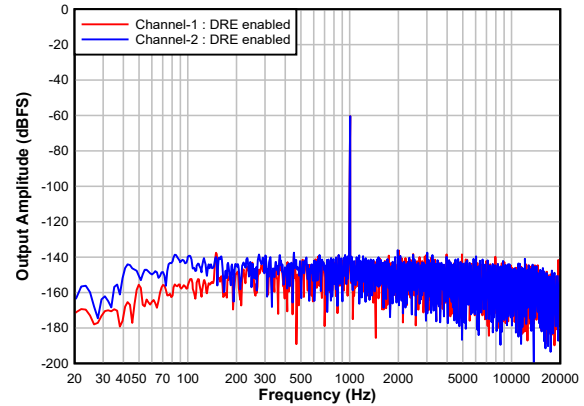

图 7-25. Differential FFT With a -1-dBr Input With DRE Disabled

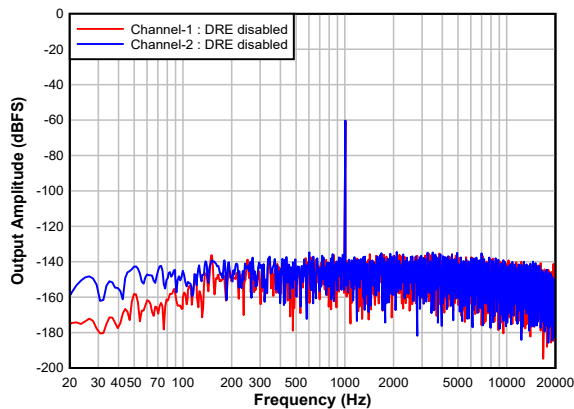

图 7-26. Common-Mode Rejection Ratio vs Ripple Frequency With 100-mV_{pp} Amplitude and DRE Disabled

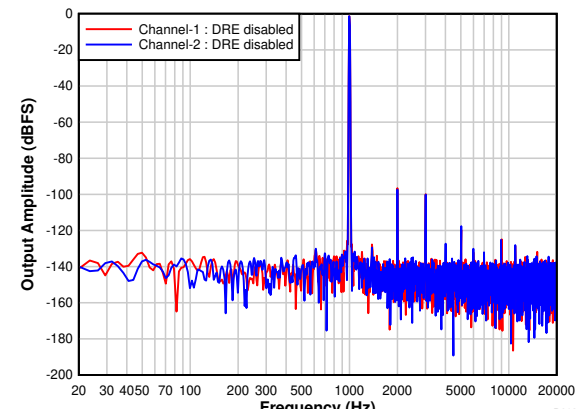

图 7-27. Common-Mode Rejection Ratio vs Ripple Frequency With 100-mV_{pp} Amplitude and DRE Enabled

7.11 Typical Characteristics (continued)

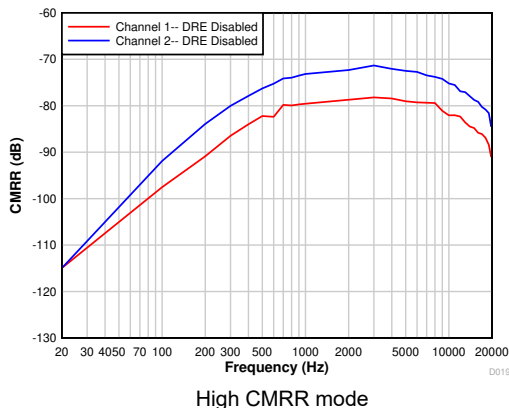
at $T_A = 25^\circ\text{C}$, $AVDD = 3.3\text{ V}$, $IOVDD = 3.3\text{ V}$, $f_{IN} = 1\text{-kHz}$ sinusoidal signal, $f_S = 48\text{ kHz}$, 32-bit audio data, $BCLK = 256 \times f_S$, TDM slave mode, PLL on, $DRE_LVL = -36\text{ dB}$, channel gain = 0 dB , and linear phase decimation filter (unless otherwise noted); all performance measurements are done with a 20-kHz, low-pass filter, and an A-weighted filter

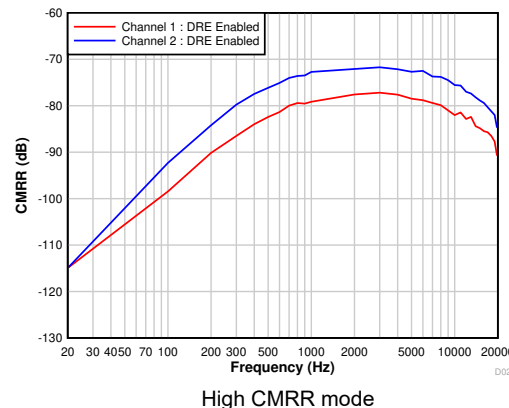

图 7-28. Input-Referred Noise vs Channel Gain



图 7-29. THD+N vs Input Amplitude With DRE Enabled

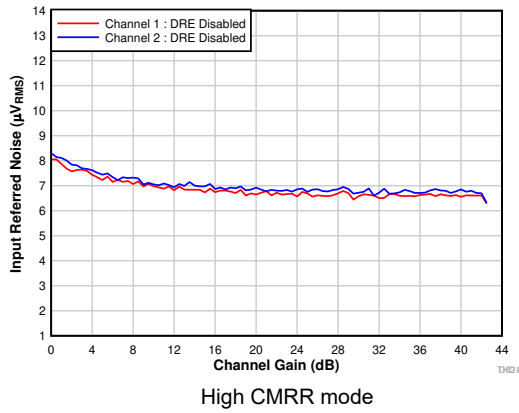

图 7-30. THD+N vs Input Amplitude With DRE Disabled

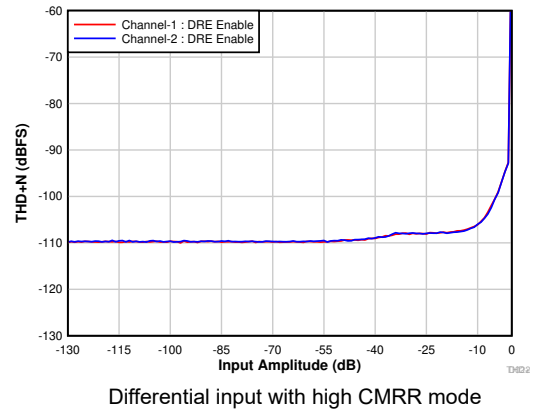

图 7-31. THD+N vs Input Frequency at -1-dBr Input With DRE Disabled

8 Detailed Description

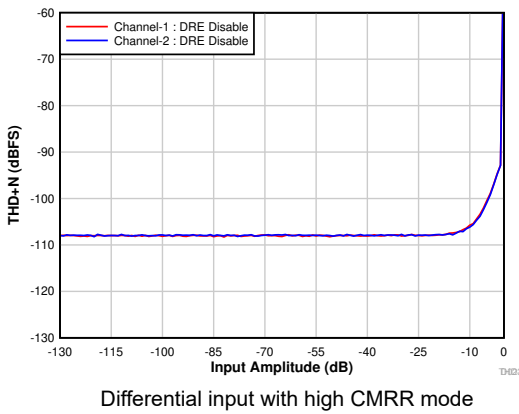
8.1 Overview

The PCM6120-Q1 is a high-performance, low-power, flexible, 2-channel, audio analog-to-digital converter (ADC) with extensive feature integration. This device is intended for applications in voice-activated systems, professional microphones, audio conferencing, portable computing, communication, and entertainment applications. The high dynamic range of the device enables far-field audio recording with high fidelity. This device integrates a host of features that reduces cost, board space, and power consumption in space-constrained, battery-powered, consumer, home, and industrial applications.

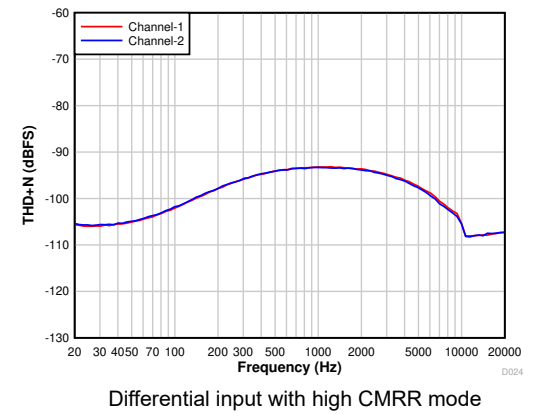
The PCM6120-Q1 consists of the following blocks:

- 2-channel, multibit, high-performance delta-sigma ($\Delta \Sigma$) ADC
- Configurable single-ended or differential audio inputs
- Low-noise, programmable microphone bias output
- Dynamic range enhancer (DRE) to support a 123-dB dynamic range
- Automatic gain controller (AGC)
- Programmable decimation filters with a linear-phase filter or a low-latency filter
- Programmable channel gain, volume control, biquad filters for each channel
- Programmable phase and gain calibration with fine resolution for each channel
- Programmable high-pass filter (HPF), and digital channel mixer
- Pulse density modulation (PDM) microphone 4-channel interface with a high-performance decimation filter
- Integrated low-jitter phase-locked loop (PLL) supporting a wide range of system clocks
- Integrated digital and analog voltage regulators to support single-supply operation

Communication to the PCM6120-Q1 for configuring the control registers is supported using an I²C interface. The device supports a highly flexible audio serial interface [time-division multiplexing (TDM), I²S, or left-justified (LJ)] to transmit audio data seamlessly in the system across devices.

The PCM6120-Q1 can support multiple devices by sharing the common TDM bus across devices. Moreover, the device includes a daisy-chain feature as well. These features relax the shared TDM bus timing requirements and board design complexities when operating multiple devices for applications requiring high audio data bandwidth.

表 8-1 lists the reference abbreviations used throughout this document to registers that control the device.

表 8-1. Abbreviations for Register References

REFERENCE	ABBREVIATION	DESCRIPTION	EXAMPLE
Page y, register z, bit k	Py_Rz_Dk	Single data bit. The value of a single bit in a register.	Page 4, register 36, bit 0 = P4_R36_D0
Page y, register z, bits k-m	Py_Rz_D[k:m]	Range of data bits. A range of data bits (inclusive).	Page 4, register 36, bits 3-0 = P4_R36_D[3:0]
Page y, register z	Py_Rz	One entire register. All eight bits in the register as a unit.	Page 4, register 36 = P4_R36
Page y, registers z-n	Py_Rz-Rn	Range of registers. A range of registers in the same page.	Page 4, registers 36, 37, 38 = P4_R36-R38

8.2 Functional Block Diagram

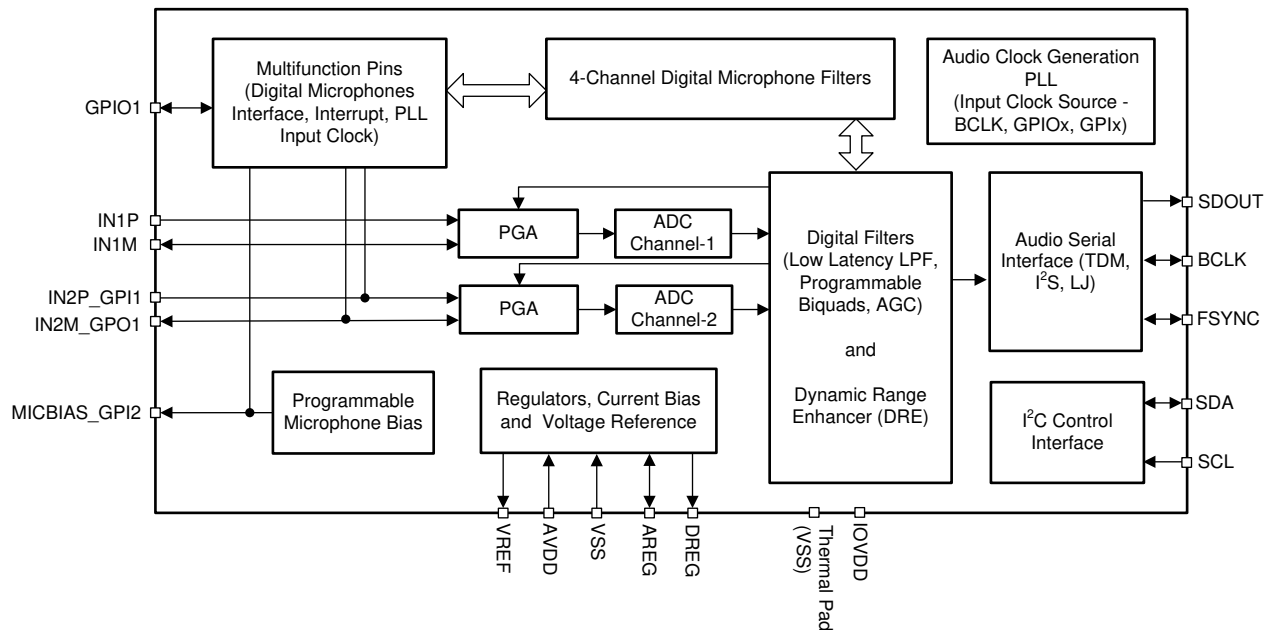

8.3 Feature Description

8.3.1 Serial Interfaces

This device has two serial interfaces: control and audio data. The control serial interface is used for device configuration. The audio data serial interface is used for transmitting audio data to the host device.

8.3.1.1 Control Serial Interfaces

The device contains configuration registers and programmable coefficients that can be set to the desired values for a specific system and application use. All registers can be accessed using I²C communication to the device. For more information, see [§ 8.5](#) for further details.

8.3.1.2 Audio Serial Interfaces

Digital audio data flows between the host processor and the PCM6120-Q1 on the digital audio serial interface (ASI), or audio bus. This highly flexible ASI bus includes a TDM mode for multichannel operation, support for I²S or left-justified protocols format, programmable data length options, very flexible master-slave configurability for bus clock lines, and the ability to communicate with multiple devices within a system directly.

The bus protocol TDM, I²S, or left-justified (LJ) format can be selected by using the ASI_FORMAT[1:0] (P0_R7_D[7:6]) register bits. As shown in 表 8-2 and 表 8-3, these modes are all most significant bit (MSB)-first, pulse code modulation (PCM) data format, with the output channel data word-length programmable as 16, 20, 24, or 32 bits by configuring the ASI_WLEN[1:0] (P0_R7_D[5:4]) register bits.

表 8-2. Audio Serial Interface Format

P0_R7_D[7:6] : ASI_FORMAT[1:0]	AUDIO SERIAL INTERFACE FORMAT
00 (default)	Time division multiplexing (TDM) mode
01	Inter IC sound (I ² S) mode
10	Left-justified (LJ) mode
11	Reserved (do not use this setting)

表 8-3. Audio Output Channel Data Word-Length

P0_R7_D[5:4] : ASI_WLEN[1:0]	AUDIO OUTPUT CHANNEL DATA WORD-LENGTH
00	Output channel data word-length set to 16 bits
01	Output channel data word-length set to 20 bits
10	Output channel data word-length set to 24 bits
11 (default)	Output channel data word-length set to 32 bits

The frame sync pin, FSYNC, is used to define the beginning of a frame and has the same frequency as the output data sample rates. The bit clock pin, BCLK, is used to clock out the digital audio data across the serial bus. The number of bit-clock cycles in a frame must accommodate all active output channels with the programmed data word length.

A frame consists of multiple time-division channel slots (up to 64) on the audio bus. This allows for either a single device or multiple PCM6120-Q1 devices sharing the same bus. The device supports up to four output channels that can be configured to place their audio data on bus slot 0 to slot 63. 表 8-4 lists the output channel slot configuration settings. In I²S and LJ mode, the slots are divided into two sets, left-channel slots and right-channel slots, as described in 节 8.3.1.2.2 and 节 8.3.1.2.3.

表 8-4. Output Channel Slot Assignment Settings

P0_R11_D[5:0] : CH1_SLOT[5:0]	OUTPUT CHANNEL 1 SLOT ASSIGNMENT
00 0000 = 0d (default)	Slot 0 for TDM or left slot 0 for I ² S, LJ.
00 0001 = 1d	Slot 1 for TDM or left slot 1 for I ² S, LJ.
...	...
01 1111 = 31d	Slot 31 for TDM or left slot 31 for I ² S, LJ.
10 0000 = 32d	Slot 32 for TDM or right slot 0 for I ² S, LJ.
...	...
11 1110 = 62d	Slot 62 for TDM or right slot 30 for I ² S, LJ.
11 1111 = 63d	Slot 63 for TDM or right slot 31 for I ² S, LJ.

Similarly, the slot assignment setting for output channel 2 to channel 8 can be done using the CH2_SLOT (P0_R12) to CH8_SLOT (P0_R18) registers, respectively.

The slot word length is the same as the output channel data word length set for the device. The output channel data word length must be set to the same value for all PCM6120-Q1 devices if all devices share the same ASI bus in a system. The maximum number of slots possible for the ASI bus in a system is limited by the available bus bandwidth, which depends upon the BCLK frequency, output data sample rate used, and the channel data word length configured.

The device also includes a feature that offsets the start of the slot data transfer with respect to the frame sync by up to 31 cycles of the bit clock. 表 8-5 lists the programmable offset configuration settings.

表 8-5. Programmable Offset Settings for the ASI Slot Start

P0_R8_D[4:0] : TX_OFFSET[4:0]	PROGRAMMABLE OFFSET SETTING FOR SLOT DATA TRANSMISSION START
0 0000 = 0d (default)	The device follows the standard protocol timing without any offset.
0 0001 = 1d	Slot start is offset by one BCLK cycle, as compared to standard protocol timing. For I ² S or LJ, the left and right slot start is offset by one BCLK cycle, as compared to standard protocol timing.
.....
1 1110 = 30d	Slot start is offset by 30 BCLK cycles, as compared to standard protocol timing. For I ² S or LJ, the left and right slot start is offset by 30 BCLK cycles, as compared to standard protocol timing.
1 1111 = 31d	Slot start is offset by 31 BCLK cycles, as compared to standard protocol timing. For I ² S or LJ, the left and right slot start is offset by 31 BCLK cycles, as compared to standard protocol timing.

The device also features the ability to invert the polarity of the frame sync pin, FSYNC, used to transfer the audio data as compared to the default FSYNC polarity used in standard protocol timing. This feature can be set using the FSYNC_POL (P0_R7_D3) register bit. Similarly, the device can invert the polarity of the bit clock pin, BCLK, which can be set using the BCLK_POL (P0_R7_D2) register bit.

8.3.1.2.1 Time Division Multiplexed Audio (TDM) Interface

In TDM mode, also known as DSP mode, the rising edge of FSYNC starts the data transfer with the slot 0 data first. Immediately after the slot 0 data transmission, the remaining slot data are transmitted in order. FSYNC and each data bit (except the MSB of slot 0 when TX_OFFSET equals 0) is transmitted on the rising edge of BCLK. 图 8-1 to 图 8-4 illustrate the protocol timing for TDM operation with various configurations.



图 8-1. TDM Mode Standard Protocol Timing (TX_OFFSET = 0)



图 8-2. TDM Mode Protocol Timing (TX_OFFSET = 2)

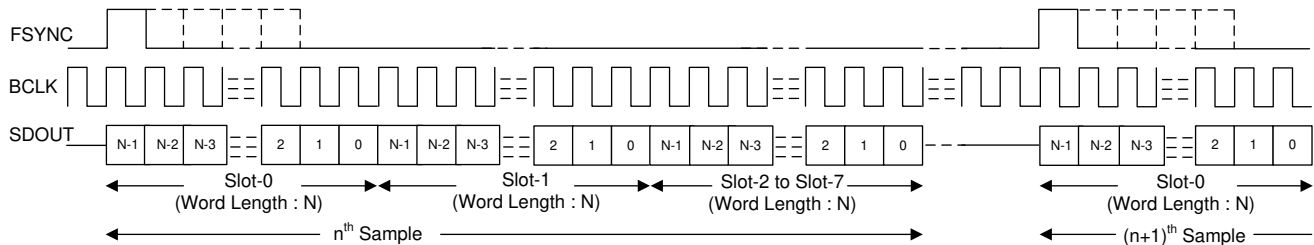

图 8-3. TDM Mode Protocol Timing (No Idle BCLK Cycles, TX_OFFSET = 2)

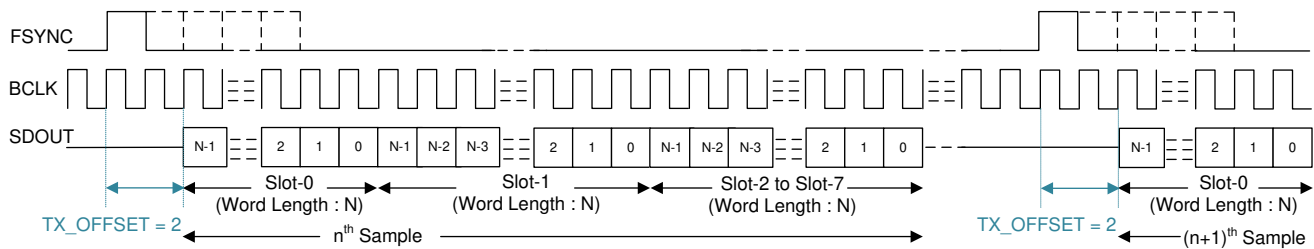

图 8-4. TDM Mode Protocol Timing (TX_OFFSET = 0 and BCLK_POL = 1)

For proper operation of the audio bus in TDM mode, the number of bit clocks per frame must be greater than or equal to the number of active output channels times the programmed word length of the output channel data. The device supports FSYNC as a pulse with a 1-cycle-wide bit clock, but also supports multiples as well. For a higher BCLK frequency operation, using TDM mode with a TX_OFFSET value higher than 0 is recommended.

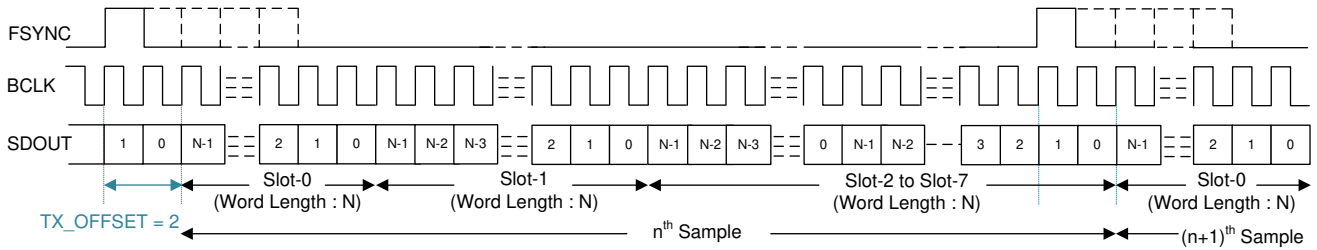
8.3.1.2.2 Inter IC Sound (I²S) Interface

The standard I²S protocol is defined for only two channels: left and right. The device extends the same protocol timing for multichannel operation. In I²S mode, the MSB of the left slot 0 is transmitted on the falling edge of BCLK in the second cycle after the *falling* edge of FSYNC. Immediately after the left slot 0 data transmission, the remaining left slot data are transmitted in order. The MSB of the right slot 0 is transmitted on the falling edge of BCLK in the second cycle after the *rising* edge of FSYNC. Immediately after the right slot 0 data transmission, the remaining right slot data are transmitted in order. FSYNC and each data bit is transmitted on the falling edge of BCLK. 图 8-5 到 图 8-8 illustrate the protocol timing for I²S operation with various configurations.

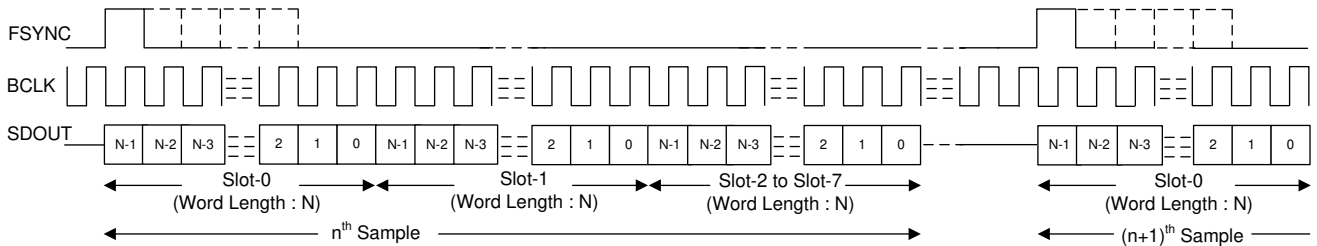

图 8-5. I²S Mode Standard Protocol Timing (TX_OFFSET = 0)



图 8-6. I²S Protocol Timing (TX_OFFSET = 1)

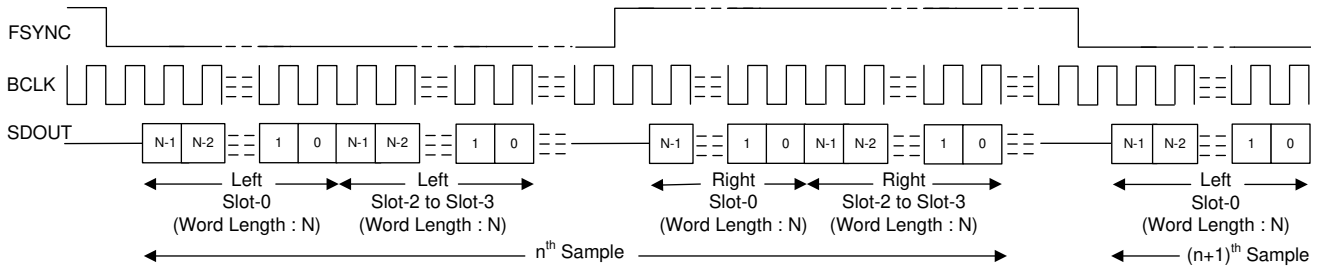

图 8-7. I²S Protocol Timing (No Idle BCLK Cycles, TX_OFFSET = 0)

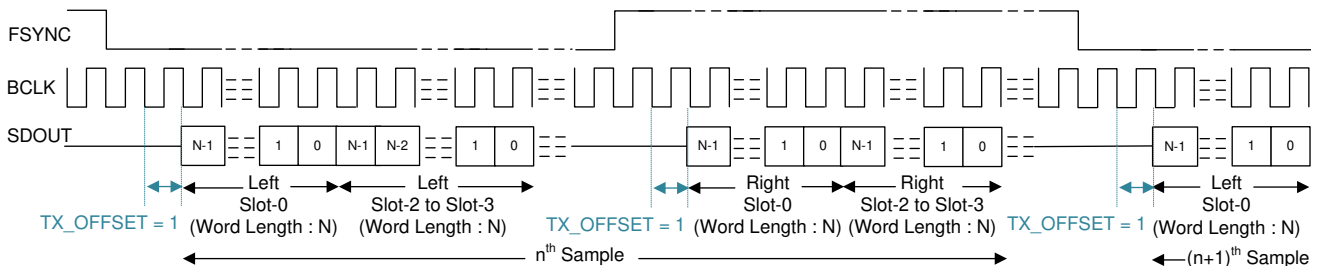

图 8-8. I²S Protocol Timing (TX_OFFSET = 0 and BCLK_POL = 1)

For proper operation of the audio bus in I²S mode, the number of bit clocks per frame must be greater than or equal to the number of active output channels (including left and right slots) times the programmed word length of the output channel data. The device FSYNC low pulse must be a number of BCLK cycles wide that is greater than or equal to the number of active left slots times the data word length configured. Similarly, the FSYNC high pulse must be a number of BCLK cycles wide that is greater than or equal to the number of active right slots times the data word length configured.

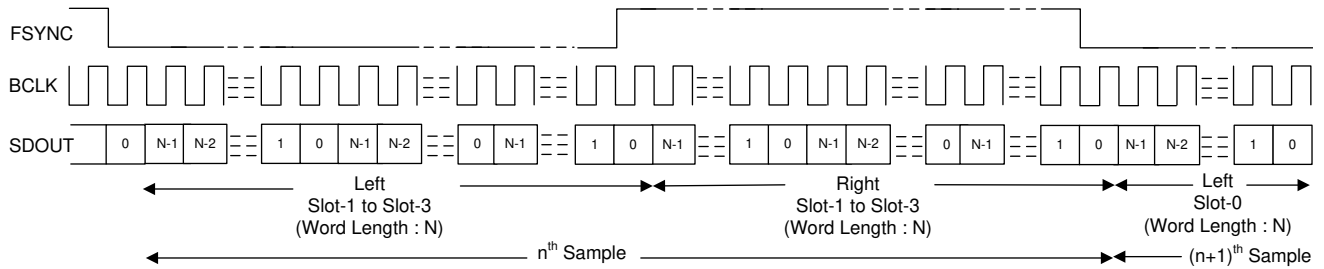
8.3.1.2.3 Left-Justified (LJ) Interface

The standard LJ protocol is defined for only two channels: left and right. The device extends the same protocol timing for multichannel operation. In LJ mode, the MSB of the left slot 0 is transmitted in the same BCLK cycle after the *rising* edge of FSYNC. Each subsequent data bit is transmitted on the falling edge of BCLK. Immediately after the left slot 0 data transmission, the remaining left slot data are transmitted in order. The MSB of the right slot 0 is transmitted in the same BCLK cycle after the *falling* edge of FSYNC. Each subsequent data bit is transmitted on the falling edge of BCLK. Immediately after the right slot 0 data transmission, the remaining right slot data are transmitted in order. FSYNC is transmitted on the falling edge of BCLK. 图 8-9 to 图 8-12 illustrate the protocol timing for LJ operation with various configurations.

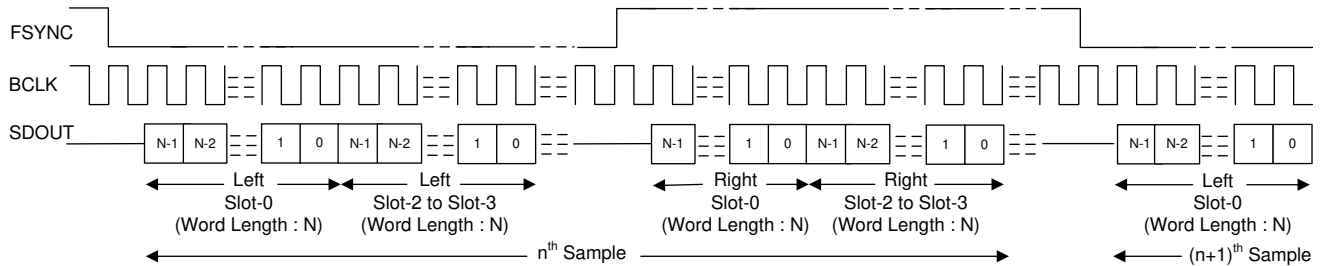

图 8-9. LJ Mode Standard Protocol Timing (TX_OFFSET = 0)



图 8-10. LJ Protocol Timing (TX_OFFSET = 2)

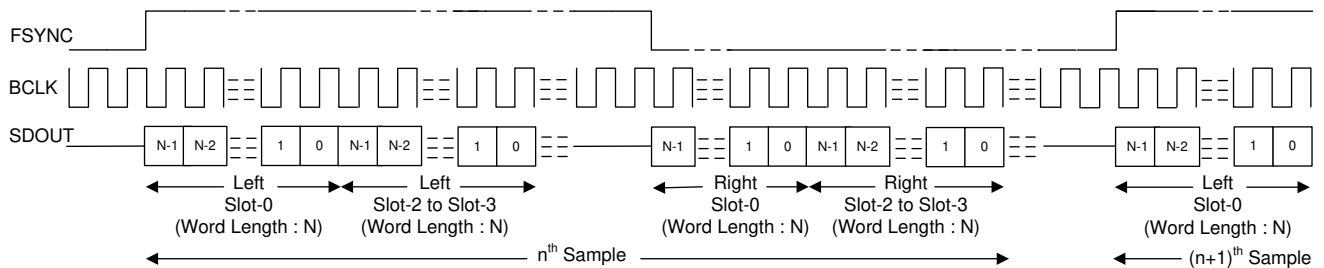

图 8-11. LJ Protocol Timing (No Idle BCLK Cycles, TX_OFFSET = 0)

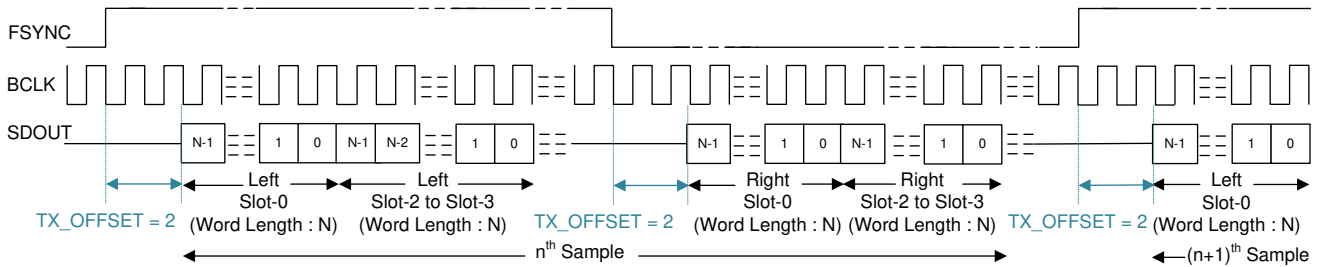

图 8-12. LJ Protocol Timing (TX_OFFSET = 1 and BCLK_POL = 1)

For proper operation of the audio bus in LJ mode, the number of bit clocks per frame must be greater than or equal to the number of active output channels (including left and right slots) times the programmed word length of the output channel data. The device FSYNC high pulse must be a number of BCLK cycles wide that is greater than or equal to the number of active left slots times the data word length configured. Similarly, the FSYNC low pulse must be number of BCLK cycles wide that is greater than or equal to the number of active right slots times the data word length configured. For a higher BCLK frequency operation, using LJ mode with a TX_OFFSET value higher than 0 is recommended.

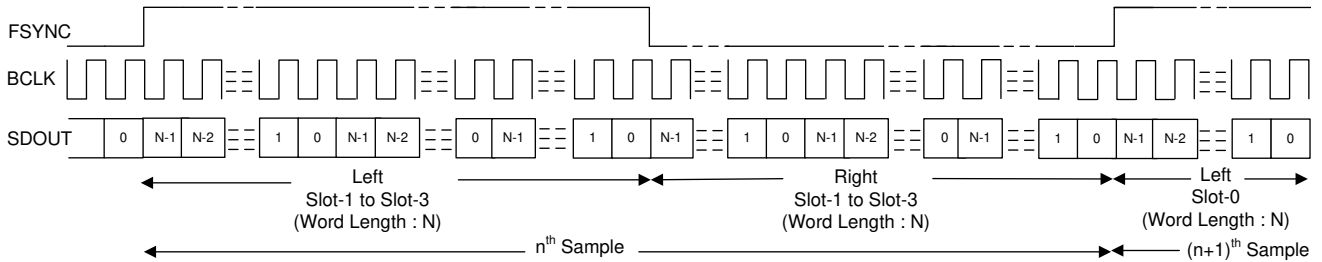
8.3.1.3 Using Multiple Devices With Shared Buses

The device has many supported features and flexible options that can be used in the system to seamlessly connect the PCM6120-Q1 and any other audio device by sharing a single common I²C control bus and an audio serial interface bus. This architecture enables multiple applications to be applied to a system that require a microphone array for beam-forming operations, audio conferencing, noise cancellation, and so forth. [图 8-13](#) shows a diagram of the PCM6120-Q1 and PCMx140-Q1 devices in a configuration where the control and audio data buses are shared.

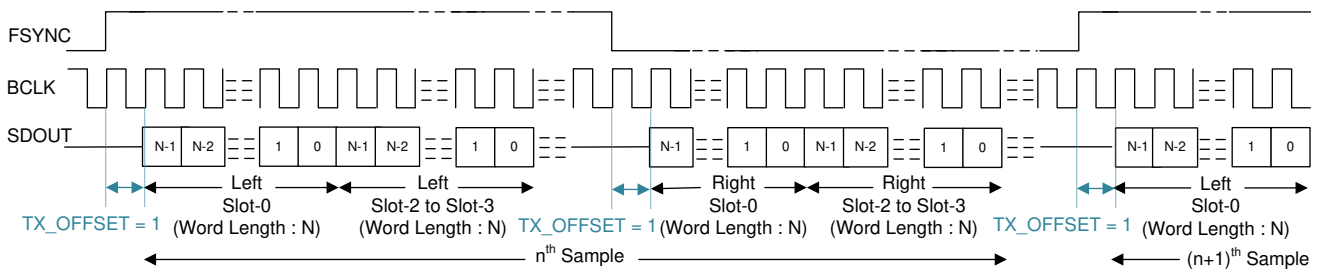

图 8-13. Multiple Devices With Shared Control and Audio Data Buses

The PCM6120-Q1 consists of the following features to enable seamless connection and interaction of multiple devices using a shared bus:

- I²C broadcast simultaneously writes to (or triggers) all PCM6120-Q1 and PCMx140-Q1 devices
- Supports up to 64 configuration output channel slots for the audio serial interface
- Tri-state feature (with enable and disable) for the unused audio data slots of the device
- Supports a bus-holder feature (with enable and disable) to keep the last driven value on the audio bus
- The GPIO1 or GPOx pin can be configured as a secondary output data lane for the audio serial interface
- The GPIO1 or GPIx pin can be used in a daisy-chain configuration of multiple devices
- Supports one BCLK cycle data latching timing to relax the timing requirement for the high-speed interface
- Programmable master and slave options for the audio serial interface
- Ability to synchronize the multiple devices for the simultaneous sampling requirement across devices

See the [Multiple TLV320ADCx140 Devices With Shared TDM and I²C Bus application report](#) for further details.

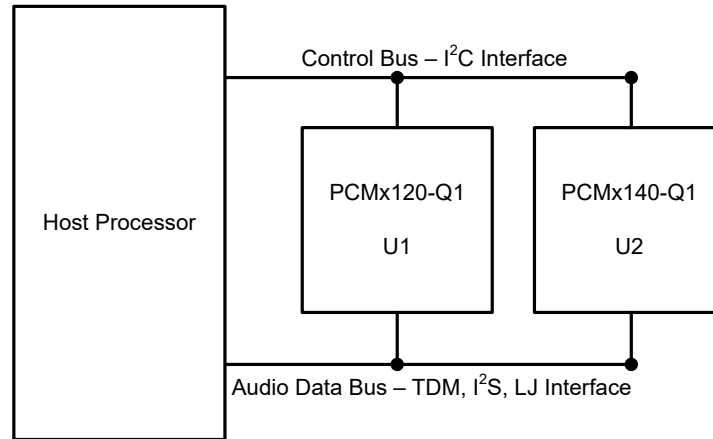
8.3.2 Phase-Locked Loop (PLL) and Clock Generation

The device has a smart auto-configuration block to generate all necessary internal clocks required for the ADC modulator and the digital filter engine used for signal processing. This configuration is done by monitoring the frequency of the FSYNC and BCLK signal on the audio bus.

The device supports the various output data sample rates (of the FSYNC signal frequency) and the BCLK to FSYNC ratio to configure all clock dividers, including the PLL configuration, internally without host programming. 表 8-6 和 表 8-7 list the supported FSYNC and BCLK frequencies.

表 8-6. Supported FSYNC (Multiples or Submultiples of 48 kHz) and BCLK Frequencies

BCLK TO FSYNC RATIO	BCLK (MHz)								
	FSYNC (8 kHz)	FSYNC (16 kHz)	FSYNC (24 kHz)	FSYNC (32 kHz)	FSYNC (48 kHz)	FSYNC (96 kHz)	FSYNC (192 kHz)	FSYNC (384 kHz)	FSYNC (768 kHz)
16	Reserved	0.256	0.384	0.512	0.768	1.536	3.072	6.144	12.288
24	Reserved	0.384	0.576	0.768	1.152	2.304	4.608	9.216	18.432
32	0.256	0.512	0.768	1.024	1.536	3.072	6.144	12.288	24.576
48	0.384	0.768	1.152	1.536	2.304	4.608	9.216	18.432	Reserved
64	0.512	1.024	1.536	2.048	3.072	6.144	12.288	24.576	Reserved
96	0.768	1.536	2.304	3.072	4.608	9.216	18.432	Reserved	Reserved
128	1.024	2.048	3.072	4.096	6.144	12.288	24.576	Reserved	Reserved
192	1.536	3.072	4.608	6.144	9.216	18.432	Reserved	Reserved	Reserved
256	2.048	4.096	6.144	8.192	12.288	24.576	Reserved	Reserved	Reserved
384	3.072	6.144	9.216	12.288	18.432	Reserved	Reserved	Reserved	Reserved
512	4.096	8.192	12.288	16.384	24.576	Reserved	Reserved	Reserved	Reserved
1024	8.192	16.384	24.576	Reserved	Reserved	Reserved	Reserved	Reserved	Reserved
2048	16.384	Reserved	Reserved	Reserved	Reserved	Reserved	Reserved	Reserved	Reserved

表 8-7. Supported FSYNC (Multiples or Submultiples of 44.1 kHz) and BCLK Frequencies

BCLK TO FSYNC RATIO	BCLK (MHz)								
	FSYNC (7.35 kHz)	FSYNC (14.7 kHz)	FSYNC (22.05 kHz)	FSYNC (29.4 kHz)	FSYNC (44.1 kHz)	FSYNC (88.2 kHz)	FSYNC (176.4 kHz)	FSYNC (352.8 kHz)	FSYNC (705.6 kHz)
16	Reserved	Reserved	0.3528	0.4704	0.7056	1.4112	2.8224	5.6448	11.2896
24	Reserved	0.3528	0.5292	0.7056	1.0584	2.1168	4.2336	8.4672	16.9344
32	Reserved	0.4704	0.7056	0.9408	1.4112	2.8224	5.6448	11.2896	22.5792
48	0.3528	0.7056	1.0584	1.4112	2.1168	4.2336	8.4672	16.9344	Reserved
64	0.4704	0.9408	1.4112	1.8816	2.8224	5.6448	11.2896	22.5792	Reserved
96	0.7056	1.4112	2.1168	2.8224	4.2336	8.4672	16.9344	Reserved	Reserved
128	0.9408	1.8816	2.8224	3.7632	5.6448	11.2896	22.5792	Reserved	Reserved
192	1.4112	2.8224	4.2336	5.6448	8.4672	16.9344	Reserved	Reserved	Reserved
256	1.8816	3.7632	5.6448	7.5264	11.2896	22.5792	Reserved	Reserved	Reserved
384	2.8224	5.6448	8.4672	11.2896	16.9344	Reserved	Reserved	Reserved	Reserved
512	3.7632	7.5264	11.2896	15.0528	22.5792	Reserved	Reserved	Reserved	Reserved
1024	7.5264	15.0528	22.5792	Reserved	Reserved	Reserved	Reserved	Reserved	Reserved
2048	15.0528	Reserved	Reserved	Reserved	Reserved	Reserved	Reserved	Reserved	Reserved

The status register ASI_STS (P0_R21), captures the device auto detect result for the FSYNC frequency and the BCLK to FSYNC ratio. If the device finds any unsupported combinations of FSYNC frequency and BCLK to FSYNC ratios, the device generates an ASI clock-error interrupt and mutes the record channels accordingly.

The device uses an integrated, low-jitter, phase-locked loop (PLL) to generate internal clocks required for the ADC modulator and digital filter engine, as well as other control blocks. The device also supports an option to

use BCLK, GPIO1, or the GPIx pin (as MCLK) as the audio clock source without using the PLL to reduce power consumption. However, the ADC performance may degrade based on jitter from the external clock source, and some processing features may not be supported if the external audio clock source frequency is not high enough. Therefore, TI recommends using the PLL for high-performance applications. More details and information on how to configure and use the device in low-power mode without using the PLL are discussed in the [TLV320ADCx120 Power Consumption Matrix Across Various Usage Scenarios application report](#).

The device also supports an audio bus master mode operation using the GPIO1 or GPIx pin (as MCLK) as the reference input clock source and supports various flexible options and a wide variety of system clocks. More details and information on master mode configuration and operation are discussed in the [Configuring and Operating TLV320ADCx120 as an Audio Bus Master application report](#).

The audio bus clock error detection and auto-detect feature automatically generates all internal clocks, but can be disabled using the ASI_ERR (P0_R9_D5) and AUTO_CLK_CFG (P0_R19_D6) register bits, respectively. In the system, this disable feature can be used to support custom clock frequencies that are not covered by the auto detect scheme. For such application use cases, care must be taken to ensure that the multiple clock dividers are all configured appropriately. Therefore, TI recommends using the PPC3 GUI for device configuration settings; for more details see the [ADCx120EVM-PDK Evaluation module user's guide](#) and the [PurePath™ console graphical development suite](#).

8.3.3 Input Channel Configurations

The device consists of two pairs of analog input pins (INxP and INxM) that can be configured as differential inputs or single-ended inputs for the recording channel. The device supports simultaneous recording of up to two channels using the high-performance multichannel ADC. The input source for the analog pins can be from electret condenser analog microphones, micro-electro-mechanical system (MEMS) analog microphones, or line-in (auxiliary) inputs from the system board. Additionally, if the application uses digital PDM microphones for the recording, then the IN2P_GPI1, IN2M_GPO1, GPIO1, and MICBIAS_GPI2 pins can be reconfigured in the device to support up to four channels for the digital microphone recording. The device can also support simultaneous recording on two analog and two digital microphone channels. 表 8-8 shows the input source selection for the record channel.

表 8-8. Input Source Selection for the Record Channel

P0_R60_D[6:5] : CH1_INSRC[1:0]	INPUT CHANNEL 1 RECORD SOURCE SELECTION
00 (default)	Analog differential input for channel 1 (this setting is valid only when the GPI1 and GPO1 pin functions are disabled)
01	Analog single-ended input for channel 1 (this setting is valid only when the GPI1 and GPO1 pin functions are disabled)
10	Digital PDM input for channel 1 (configure the GPIx and GPOx pin accordingly for PDMDIN1 and PDMCLK)
11	Reserved (do not use this setting)

Similarly, the input source selection setting for input channel 2, channel 3, and channel 4 can be configured using the CH2_INSRC[1:0] (P0_R65_D[6:5]), CH3_INSRC[1:0] (P0_R70_D[6:5]), and CH4_INSRC[1:0] (P0_R75_D[6:5]) register bits, respectively.

Typically, voice or audio signal inputs are capacitively coupled (AC coupled) to the device; however, the device also supports an option for DC-coupled inputs to save board space. This configuration can be done independently for each channel by setting the CH1_DC (P0_R60_D4), CH2_DC (P0_R65_D4), CH3_DC (P0_R70_D4), and CH4_DC (P0_R75_D4) register bits. The INxM pin can be directly grounded in DC-coupled mode (see 图 8-14), but the INxM pin must be grounded after the AC-coupling capacitor in AC-coupled mode (see 图 8-15) for the single-ended input configuration. For the best dynamic range performance, the differential AC-coupled input must be used with the DRE enabled.



图 8-14. Single-Ended, DC-Coupled Input Connection



图 8-15. Single-Ended, AC-Coupled Input Connection

The device allows for flexibility in choosing the typical input impedance on INxP or INxM from 2.5 k Ω (default), 10 k Ω , and 20 k Ω based on the input source impedance. The higher input impedance results in slightly higher noise or lower dynamic range. 表 8-9 lists the configuration register settings for the input impedance for the record channel.

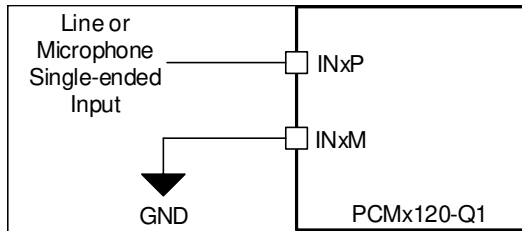
表 8-9. Input Impedance Selection for the Record Channel

P0_R60_D[3:2] : CH1_IMP[1:0]	CHANNEL 1 INPUT IMPEDANCE SELECTION
00 (default)	Channel 1 input impedance typical value is 2.5 k Ω on INxP or INxM
01	Channel 1 input impedance typical value is 10 k Ω on INxP or INxM
10	Channel 1 input impedance typical value is 20 k Ω on INxP or INxM
11	Reserved (do not use this setting)

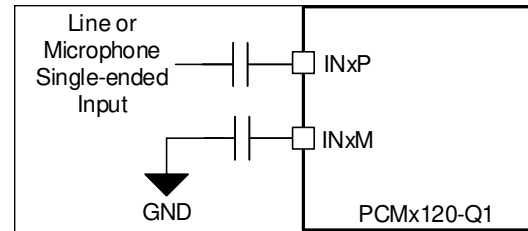
Similarly, the input impedance selection setting for input channel 2 can be configured using the CH2_IMP[1:0] (P0_R65_D[3:2]) register bits.

The value of the coupling capacitor in AC-coupled mode must be chosen so that the high-pass filter formed by the coupling capacitor and the input impedance do not affect the signal content. Before proper recording can begin, this coupling capacitor must be charged up to the common-mode voltage at power up. To enable quick charging, the device has modes to speed up the charging of the coupling capacitor. The default value of the quick-charge timing is set for a coupling capacitor up to 1 μ F. However, if a higher-value capacitor is used in the system, then the quick-charging timing can be increased by using the INCAP_QCHG (P0_R5_D[5:4]) register bits. For best distortion performance, use the low-voltage coefficient capacitors for AC coupling.

The PCM6120-Q1 can also support a higher input common-mode tolerance at the expense of noise performance by a few decibels. The device supports three different modes with different common-mode tolerances, which can be configured using the CH1_INP_CM_TOL_CFG[1:0] (P0_R58_D[7:6]) register bits. 表 8-10 lists the configuration register settings for the input impedance for the record channel.

表 8-10. Common-Mode Tolerance Mode Selection for Record Channel

P0_R58_D[7:6] : CH1_INP_CM_TOL_CFG[1:0]	CHANNEL 1 INPUT COMMON-MODE TOLERANCE
00 (default)	Channel 1 input common-mode tolerance of: AC-coupled input = 100 mV _{PP} , DC-coupled input = 2.82 V _{PP} .
01	Channel 1 input common-mode tolerance of: AC/DC-coupled input = 1 V _{PP} .
10 (high CMRR mode)	Channel 1 input common-mode tolerance of: AC/DC-coupled input = 0-AVDD (supported only with an input impedance of 10 k Ω and 20 k Ω). For input impedance of 2.5 k Ω , the input common-mode tolerance is 0.4 V to 2.6 V.
11	Reserved (do not use this setting)

Similarly, the common-mode tolerance setting for input channel 2 can be configured using the CH2_INP_CM_TOL_CFG[1:0] (P0_R58_D[5:4]) register bits. See the [Input Common Mode Tolerance and High CMRR modes for TLV320ADCx120 Devices application report](#) for further details.

8.3.4 Reference Voltage

All audio data converters require a DC reference voltage. The PCM6120-Q1 achieves low-noise performance by internally generating a low-noise reference voltage. This reference voltage is generated using a band-gap circuit with high PSRR performance. This audio converter reference voltage must be filtered externally using a minimum 1- μ F capacitor connected from the VREF pin to analog ground (AVSS).

The value of this reference voltage can be configured using the P0_R59_D[1:0] register bits and must be set to an appropriate value based on the desired full-scale input for the device and the AVDD supply voltage available in the system. The default VREF value is set to 2.75 V, which in turn supports a 2- V_{RMS} differential full-scale input to the device. The required minimum AVDD voltage for this mode is 3 V. 表 8-11 lists the various VREF settings supported along with required AVDD range and the supported full-scale input signal for that configuration.

表 8-11. VREF Programmable Settings

P0_R59_D[1:0] : ADC_FSCALE[1:0]	VREF OUTPUT VOLTAGE (Same as Internal ADC VREF)	DIFFERENTIAL FULL-SCALE INPUT SUPPORTED	SINGLE-ENDED FULL-SCALE INPUT SUPPORTED	AVDD RANGE REQUIREMENT
00 (default)	2.75 V	2 V_{RMS}	1 V_{RMS}	3 V to 3.6 V
01	2.5 V	1.818 V_{RMS}	0.909 V_{RMS}	2.8 V to 3.6 V
10	1.375 V	1 V_{RMS}	0.5 V_{RMS}	1.7 V to 1.9 V
11	Reserved	Reserved	Reserved	Reserved

To achieve low-power consumption, this audio reference block is powered down as described in the 节 8.4.1 section. When exiting sleep mode, the audio reference block is powered up using the internal fast-charge scheme and the VREF pin settles to its steady-state voltage after the settling time (a function of the decoupling capacitor on the VREF pin). This time is approximately equal to 3.5 ms when using a 1- μ F decoupling capacitor. If a higher-value decoupling capacitor is used on the VREF pin, the fast-charge setting must be reconfigured using the VREF_QCHG (P0_R2_D[4:3]) register bits, which support options of 3.5 ms (default), 10 ms, 50 ms, or 100 ms.

8.3.5 Programmable Microphone Bias

The device integrates a built-in, low-noise microphone bias pin that can be used in the system for biasing electret-condenser microphones or providing the supply to the MEMS analog or digital microphone. The integrated bias amplifier supports up to 5 mA of load current that can be used for multiple microphones and is designed to provide a combination of high PSRR, low noise, and programmable bias voltages to allow the biasing to be fine tuned for specific microphone combinations.

When using this MICBIAS pin for biasing or supplying to multiple microphones, avoid any common impedance on the board layout for the MICBIAS connection to minimize coupling across microphones. 表 8-12 shows the available microphone bias programmable options.

表 8-12. MICBIAS Programmable Settings

P0_R59_D[6:4] : MBIAS_VAL[2:0]	P0_R59_D[1:0] : ADC_FSCALE[1:0]	MICBIAS OUTPUT VOLTAGE
000 (default)	00 (default)	2.75 V (same as the VREF output)
	01	2.5 V (same as the VREF output)
	10	1.375 V (same as the VREF output)
001	00 (default)	3.014 V (1.096 times the VREF output)
	01	2.740 V (1.096 times the VREF output)
	10	1.507 V (1.096 times the VREF output)
010 to 101	XX	Reserved (do not use these settings)
110	XX	Same as AVDD
111	XX	Reserved (do not use this setting)

The microphone bias output can be powered on or powered off (default) by configuring the MICBIAS_PDZ (P0_R117_D7) register bit. Additionally, the device provides an option to configure the GPIO1 or GPIx pin to directly control the microphone bias output powering on or off. This feature is useful to control the microphone directly without engaging the host for I²C communication. The MICBIAS_PDZ (P0_R117_D7) register bit value is ignored if the GPIO1 or GPIx pin is configured to set the microphone bias on or off.

8.3.6 Signal-Chain Processing

The PCM6120-Q1 signal chain is comprised of very-low-noise, high-performance, and low-power analog blocks and highly flexible and programmable digital processing blocks. The high performance and flexibility combined with a compact package makes the PCM6120-Q1 optimized for a variety of end-equipments and applications that require multichannel audio capture. [Figure 8-16](#) shows a conceptual block diagram that highlights the various building blocks used in the signal chain, and how the blocks interact in the signal chain.



图 8-16. Signal-Chain Processing Flowchart

The front-end PGA is very low noise, with a 123 -dB dynamic range performance. Along with a low-noise and low-distortion, multibit, delta-sigma ADC, the front-end PGA enables the PCM6120-Q1 to record a far-field audio signal with very high fidelity, both in quiet and loud environments. Moreover, the ADC architecture has inherent antialias filtering with a high rejection of out-of-band frequency noise around multiple modulator frequency components. Therefore, the device prevents noise from aliasing into the audio band during ADC sampling. Further on in the signal chain, an integrated, high-performance multistage digital decimation filter sharply cuts off any out-of-band frequency noise with high stop-band attenuation.

The device also has an integrated programmable biquad filters that allows for custom low-pass, high-pass, or any other desired frequency shaping. Thus, the overall signal chain architecture removes the requirement to add external components for antialiasing low-pass filtering, and thus saves drastically on the external system component cost and board space. See the [TLV320ADCx140 Integrated Analog Anti-Aliasing Filter and Flexible Digital Filter application report](#) for further details.

The signal chain also consists of various highly programmable digital processing blocks such as phase calibration, gain calibration, high-pass filter, digital summer or mixer, biquad filters, and volume control. The details on these processing blocks are discussed further in this section. The device also supports up to four digital PDM microphone recording channels when the analog record channels are not used. Channels 1 to 2 in the signal chain block diagram of [Figure 8-16](#) are as described in this section, however, channels 3 to 4 only support the digital microphone recording option and do not support the digital summer or mixer option.

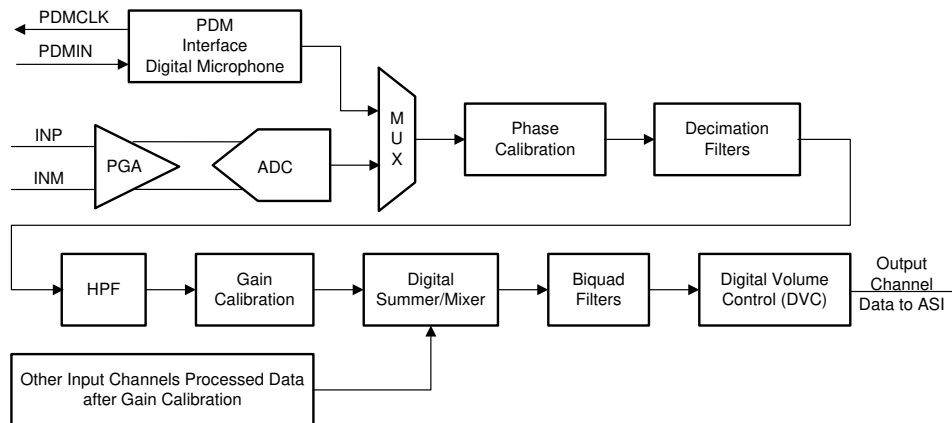
The desired input channels for recording can be enabled or disabled by using the IN_CH_EN (P0_R115) register, and the output channels for the audio serial interface can be enabled or disabled by using the ASI_OUT_EN (P0_R116) register. In general, the device supports simultaneous power-up and power-down of all active channels for simultaneous recording. However, based on the application needs, if some channels must be powered-up or powered-down dynamically when the other channel recording is on, then that use case is supported by setting the DYN_CH_PUPD_EN (P0_R117_D4) register bit to 1'b1.

The device supports an input signal bandwidth up to 80 kHz, which allows the high-frequency non-audio signal to be recorded by using a 176.4-kHz (or higher) sample rate.

For output sample rates of 48 kHz or lower, the device supports all features for 4-channel recording and various programmable processing blocks. However, for output sample rates higher than 48 kHz, there are limitations in the number of simultaneous channel recordings supported and the number of biquad filters and such. See the [TLV320ADCx140 Sampling Rates and Programmable Processing Blocks Supported application report](#) for further details.

8.3.6.1 Programmable Channel Gain and Digital Volume Control

The device has an independent programmable channel gain setting for each input channel that can be set to the appropriate value based on the maximum input signal expected in the system and the ADC VREF setting used (see the [§ 8.3.4](#) section), which determines the ADC full-scale signal level.

Configure the desired channel gain setting before powering up the ADC channel and do not change this setting when the ADC is powered on. The programmable range supported for each channel gain is from 0 dB to 42 dB in steps of 0.5 dB. To achieve low-noise performance, the device internal logic first maximizes the gain for the front-end, low-noise analog PGA, which supports a dynamic range of 120 dB, and then applies any residual programmed channel gain in the digital processing block.

[表 8-13](#) shows the programmable options available for the channel gain.

表 8-13. Channel Gain Programmable Settings

P0_R61_D[7:1] : CH1_GAIN[6:0]	CHANNEL GAIN SETTING FOR INPUT CHANNEL 1
000 0000 = 0d (default)	Input channel 1 gain is set to 0 dB
000 0001 = 1d	Input channel 1 gain is set to 0.5 dB
000 0010 = 2d	Input channel 1 gain is set to 1 dB
...	...
101 0011 = 83d	Input channel 1 gain is set to 41.5 dB
101 0100 = 84d	Input channel 1 gain is set to 42 dB
101 0101 to 111 1111 = 85d to 127d	Reserved (do not use these settings)

Similarly, the channel gain setting for input channel 2 can be configured using the CH2_GAIN (P0_R66_D[7:1]) register bits. The channel gain feature is not available for the digital microphone record path.

The device also supports gain change when the ADC is enabled. The device supports multiple configurations to limit the audible artifacts during dynamic gain change. This feature can be configured by using the OTF_GAIN_CHANGE_CFG (P0_R113_D[7:6]) register bits.

The device also has a programmable digital volume control with a range from -100 dB to +27 dB in steps of 0.5 dB with the option to mute the channel recording. The digital volume control value can be changed dynamically when the ADC channel is powered up and recording. During volume control changes, the soft ramp-up or ramp-down volume feature is used internally to avoid any audible artifacts. Soft-stepping can be entirely disabled using the DISABLE_SOFT_STEP (P0_R108_D4) register bit.

The digital volume control setting is independently available for each output channel, including the digital microphone record channel. However, the device also supports an option to gang-up the volume control setting for all channels together using the channel 1 digital volume control setting, regardless if channel 1 is powered up or powered down. This gang-up can be enabled using the DVOL_GANG (P0_R108_D7) register bit.

表 8-14 shows the programmable options available for the digital volume control.

表 8-14. Digital Volume Control (DVC) Programmable Settings

P0_R62_D[7:0] : CH1_DVOL[7:0]	DVC SETTING FOR OUTPUT CHANNEL 1
0000 0000 = 0d	Output channel 1 DVC is set to mute
0000 0001 = 1d	Output channel 1 DVC is set to - 100 dB
0000 0010 = 2d	Output channel 1 DVC is set to - 99.5 dB
0000 0011 = 3d	Output channel 1 DVC is set to - 99 dB
...	...
1100 1000 = 200d	Output channel 1 DVC is set to - 0.5 dB
1100 1001 = 201d (default)	Output channel 1 DVC is set to 0 dB
1100 1010 = 202d	Output channel 1 DVC is set to 0.5 dB
...	...
1111 1101 = 253d	Output channel 1 DVC is set to 26 dB
1111 1110 = 254d	Output channel 1 DVC is set to 26.5 dB
1111 1111 = 255d	Output channel 1 DVC is set to 27 dB

Similarly, the digital volume control setting for output channel 2 to channel 4 can be configured using the CH2_DVOL (P0_R67) to CH4_DVOL (P0_R77) register bits, respectively.

The internal digital processing engine soft ramps up the volume from a muted level to the programmed volume level when the channel is powered up, and the internal digital processing engine soft ramps down the volume from a programmed volume to mute when the channel is powered down. This soft-stepping of volume is done to prevent abruptly powering up and powering down the record channel. This feature can also be entirely disabled using the DISABLE_SOFT_STEP (P0_R108_D4) register bit.

8.3.6.2 Programmable Channel Gain Calibration

Along with the programmable channel gain and digital volume, this device also provides programmable channel gain calibration. The gain of each channel can be finely calibrated or adjusted in steps of 0.1 dB for a range of - 0.8-dB to 0.7-dB gain error. This adjustment is useful when trying to match the gain across channels resulting from external components and microphone sensitivity. This feature, in combination with the regular digital volume control, allows the gains across all channels to be matched for a wide gain error range with a resolution of 0.1 dB. 表 8-15 shows the programmable options available for the channel gain calibration.

表 8-15. Channel Gain Calibration Programmable Settings

P0_R63_D[7:4] : CH1_GCAL[3:0]	CHANNEL GAIN CALIBRATION SETTING FOR INPUT CHANNEL 1
0000 = 0d	Input channel 1 gain calibration is set to - 0.8 dB
0001 = 1d	Input channel 1 gain calibration is set to - 0.7 dB
...	...
1000 = 8d (default)	Input channel 1 gain calibration is set to 0 dB
...	...
1110 = 14d	Input channel 1 gain calibration is set to 0.6 dB
1111 = 15d	Input channel 1 gain calibration is set to 0.7 dB

Similarly, the channel gain calibration setting for input channel 2 to channel 4 can be configured using the CH2_GCAL (P0_R68) to CH4_GCAL (P0_R78) register bits, respectively.

8.3.6.3 Programmable Channel Phase Calibration

In addition to the gain calibration, the phase delay in each channel can be finely calibrated or adjusted in steps of one modulator clock cycle for a cycle range of 0 to 255 for the phase error of the analog microphone. The modulator clock, which is the same clock used for ADC_MOD_CLK, is 6.144 MHz (the output data sample rate is multiples or submultiples of 48 kHz) or 5.6448 MHz (the output data sample rate is multiples or submultiples of 44.1 kHz). For the digital microphone interface, the phase calibration clock is dependent on the PDM clock used. For a PDM_CLK of 6.144 MHz (the output data sample rate is multiples or submultiples of 48 kHz) or 5.6448 MHz (the output data sample rate is multiples or submultiples of 44.1 kHz), the phase calibration clock is the same as PDM_CLK. For a PDM_CLK equal to or lower than 3.072 MHz (the output data sample rate is multiples or submultiples of 48 kHz), the phase calibration clock used is 3.072 MHz. Similarly, for a PDM_CLK of 2.8224 MHz, 1.4112 MHz, or 705.6 kHz (the output data sample rate is multiples or submultiples of 44.1 kHz), and the phase calibration clock used is 2.8224 MHz. This feature is very useful for applications that must match the phase with fine resolution between each channel, including any phase mismatch across channels resulting from external components or microphones. 表 8-16 shows the available programmable options for channel phase calibration for the analog or digital microphone with a PDM_CLK of 6.144 MHz or 5.6448 MHz.

表 8-16. Channel Phase Calibration Programmable Settings

P0_R64_D[7:0] : CH1_PCAL[7:0]	CHANNEL PHASE CALIBRATION SETTING FOR INPUT CHANNEL 1
0000 0000 = 0d (default)	Input channel 1 phase calibration with no delay
0000 0001 = 1d	Input channel 1 phase calibration delay is set to one cycle of the modulator clock
0000 0010 = 2d	Input channel 1 phase calibration delay is set to two cycles of the modulator clock
...	...
1111 1110 = 254d	Input channel 1 phase calibration delay is set to 254 cycles of the modulator clock
1111 1111 = 255d	Input channel 1 phase calibration delay is set to 255 cycles of the modulator clock

For a digital microphone interface with a PDM_CLK frequency below 3.072 MHz, the phase calibration range is from 0 to 127 of the phase calibration clock (3.072 MHz for the output data sample rate is multiples or submultiples of 48 kHz and 2.8224 MHz for the output data sample rate is multiples or submultiples of 44.1 kHz). This range can be configured using CH1_PCAL[7:1] for channel 1.

Similarly, the channel phase calibration setting for input channel 2 to channel 4 can be configured using the CH2_PCAL (P0_R69) to CH4_PCAL (P0_R79) register bits, respectively.

The phase calibration feature must not be used when the analog input and PDM input are used together for simultaneous conversion.

8.3.6.4 Programmable Digital High-Pass Filter

To remove the DC offset component and attenuate the undesired low-frequency noise content in the record data, the device supports a programmable high-pass filter (HPF). The HPF is not a channel-independent filter setting but is globally applicable for all ADC channels. This HPF is constructed using the first-order infinite impulse response (IIR) filter, and is efficient enough to filter out possible DC components of the signal. 表 8-17 shows the predefined -3-dB cutoff frequencies available that can be set by using the HPF_SEL[1:0] register bits of P0_R107. Additionally, to achieve a custom -3-dB cutoff frequency for a specific application, the device also allows the first-order IIR filter coefficients to be programmed when the HPF_SEL[1:0] register bits are set to 2'b00. 图 8-17 shows a frequency response plot for the HPF filter.

表 8-17. HPF Programmable Settings

P0_R107_D[1:0] : HPF_SEL[1:0]	-3-dB CUTOFF FREQUENCY SETTING	-3-dB CUTOFF FREQUENCY AT 16-kHz SAMPLE RATE	-3-dB CUTOFF FREQUENCY AT 48-kHz SAMPLE RATE
00	Programmable 1st-order IIR filter	Programmable 1st-order IIR filter	Programmable 1st-order IIR filter
01 (default)	$0.00025 \times f_s$	4 Hz	12 Hz
10	$0.002 \times f_s$	32 Hz	96 Hz
11	$0.008 \times f_s$	128 Hz	384 Hz



图 8-17. HPF Filter Frequency Response Plot

方程式 1 gives the transfer function for the first-order programmable IIR filter:

$$H(z) = \frac{N_0 + N_1 z^{-1}}{2^{31} - D_1 z^{-1}} \quad (1)$$

The frequency response for this first-order programmable IIR filter with default coefficients is flat at a gain of 0 dB (all-pass filter). The host device can override the frequency response by programming the IIR coefficients in 表 8-18 to achieve the desired frequency response for high-pass filtering or any other desired filtering. If HPF_SEL[1:0] are set to 2'b00, the host device must write these coefficients values for the desired frequency response before powering-up any ADC channel for recording. 表 8-18 shows the filter coefficients for the first-order IIR filter.

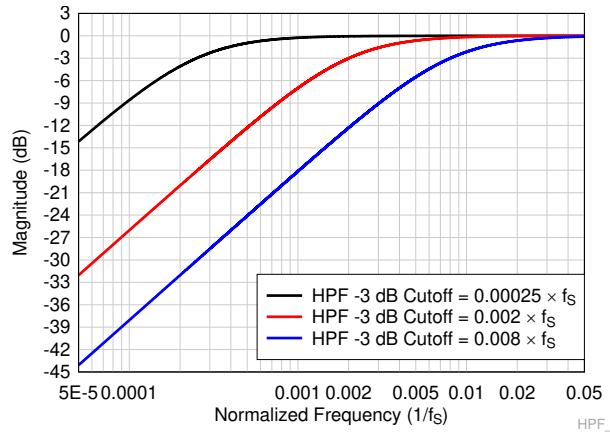
表 8-18. 1st-Order IIR Filter Coefficients

FILTER	FILTER COEFFICIENT	DEFAULT COEFFICIENT VALUE	COEFFICIENT REGISTER MAPPING
Programmable 1st-order IIR filter (can be allocated to HPF or any other desired filter)	N ₀	0x7FFFFFFF	P4_R72-R75
	N ₁	0x00000000	P4_R76-R79
	D ₁	0x00000000	P4_R80-R83

8.3.6.5 Programmable Digital Biquad Filters

The device supports up to 12 programmable digital biquad filters. These highly efficient filters achieve the desired frequency response. In digital signal processing, a digital biquad filter is a second-order, recursive linear filter with two poles and two zeros. [方程式 2](#) gives the transfer function of each biquad filter:

$$H(z) = \frac{N_0 + 2N_1z^{-1} + N_2z^{-2}}{2^{31} - 2D_1z^{-1} - D_2z^{-2}} \quad (2)$$

The frequency response for the biquad filter section with default coefficients is flat at a gain of 0 dB (all-pass filter). The host device can override the frequency response by programming the biquad coefficients to achieve the desired frequency response for a low-pass, high-pass, or any other desired frequency shaping. The programmable coefficients for the mixer operation are located in [节 8.6.4.1](#) and [节 8.6.4.2](#). If biquad filtering is required, then the host device must write these coefficients values before powering up any ADC channels for recording. As described in [表 8-19](#), these biquad filters can be allocated for each output channel based on the BIQUAD_CFG[1:0] register setting of P0_R108. By setting BIQUAD_CFG[1:0] to 2'b00, the biquad filtering for all record channels is disabled and the host device can choose this setting if no additional filtering is required for the system application. See the [TLV320ADCx140 Programmable Biquad Filter Configuration and Applications application report](#) for further details.

表 8-19. Biquad Filter Allocation to the Record Output Channel

PROGRAMMABLE BIQUAD FILTER	RECORD OUTPUT CHANNEL ALLOCATION USING P0_R108_D[6:5] REGISTER SETTING		
	BIQUAD_CFG[1:0] = 2'b01 (1 Biquad per Channel)	BIQUAD_CFG[1:0] = 2'b10 (Default) (2 Biquads per Channel)	BIQUAD_CFG[1:0] = 2'b11 (3 Biquads per Channel)
Biquad filter 1	Allocated to output channel 1	Allocated to output channel 1	Allocated to output channel 1
Biquad filter 2	Allocated to output channel 2	Allocated to output channel 2	Allocated to output channel 2
Biquad filter 3	Allocated to output channel 3	Allocated to output channel 3	Allocated to output channel 3
Biquad filter 4	Allocated to output channel 4	Allocated to output channel 4	Allocated to output channel 4
Biquad filter 5	Not used	Allocated to output channel 1	Allocated to output channel 1
Biquad filter 6	Not used	Allocated to output channel 2	Allocated to output channel 2
Biquad filter 7	Not used	Allocated to output channel 3	Allocated to output channel 3
Biquad filter 8	Not used	Allocated to output channel 4	Allocated to output channel 4
Biquad filter 9	Not used	Not used	Allocated to output channel 1
Biquad filter 10	Not used	Not used	Allocated to output channel 2
Biquad filter 11	Not used	Not used	Allocated to output channel 3
Biquad filter 12	Not used	Not used	Allocated to output channel 4

[表 8-20](#) shows the biquad filter coefficients mapping to the register space.

表 8-20. Biquad Filter Coefficients Register Mapping

PROGRAMMABLE BIQUAD FILTER	BIQUAD FILTER COEFFICIENTS REGISTER MAPPING	PROGRAMMABLE BIQUAD FILTER	BIQUAD FILTER COEFFICIENTS REGISTER MAPPING
Biquad filter 1	P2_R8-R27	Biquad filter 7	P3_R8-R27
Biquad filter 2	P2_R28-R47	Biquad filter 8	P3_R28-R47
Biquad filter 3	P2_R48-R67	Biquad filter 9	P3_R48-R67
Biquad filter 4	P2_R68-R87	Biquad filter 10	P3_R68-R87
Biquad filter 5	P2_R88-R107	Biquad filter 11	P3_R88-R107
Biquad filter 6	P2_R108-R127	Biquad filter 12	P3_R108-R127

8.3.6.6 Programmable Channel Summer and Digital Mixer

For applications that require an even higher SNR than that supported for each channel, the device digital summing mode can be used. In this mode, the digital record data are summed up across the channel with an equal weightage factor, which helps in reducing the effective record noise. 表 8-21 lists the configuration settings available for channel summing mode.

表 8-21. Channel Summing Mode Programmable Settings

P0_R107_D[3:2] : CH_SUM[1:0]	CHANNEL SUMMING MODE FOR INPUT CHANNELS	SNR AND DYNAMIC RANGE BOOST
00 (default)	Channel summing mode is disabled	Not applicable
01	Output channel 1 = (input channel 1 + input channel 2) / 2 Output channel 2 = (input channel 1 + input channel 2) / 2	Around 3-dB boost in SNR and dynamic range
10	Reserved (do not use this setting)	Not applicable
11	Reserved (do not use this setting)	Not applicable

The device additionally supports a fully programmable mixer feature that can mix the various input channels with their custom programmable scale factor to generate the final output channels. The programmable mixer feature is available only if CH_SUM[1:0] is set to 2'b00. The mixer function is supported for all input channels. 图 8-18 shows a block diagram that describes the mixer 1 operation to generate output channel 1. The programmable coefficients for the mixer operation are located in the 节 8.6.4.3 section.



图 8-18. Programmable Digital Mixer Block Diagram

A similar mixer operation is performed by mixer 2 to generate output channel 2.

8.3.6.7 Configurable Digital Decimation Filters

The device record channel includes a high dynamic range, built-in digital decimation filter to process the oversampled data from the multibit delta-sigma ($\Delta \Sigma$) modulator to generate digital data at the same Nyquist sampling rate as the FSYNC rate. As illustrated in 图 8-16, this decimation filter can also be used for processing the oversampled PDM stream from the digital microphone. The decimation filter can be chosen from three different types, depending on the required frequency response, group delay, and phase linearity requirements for the target application. The selection of the decimation filter option can be done by configuring the DECI_FILTER (P0_R107_D[5:4]) register bits. 表 8-22 shows the configuration register setting for the decimation filter mode selection for the record channel.

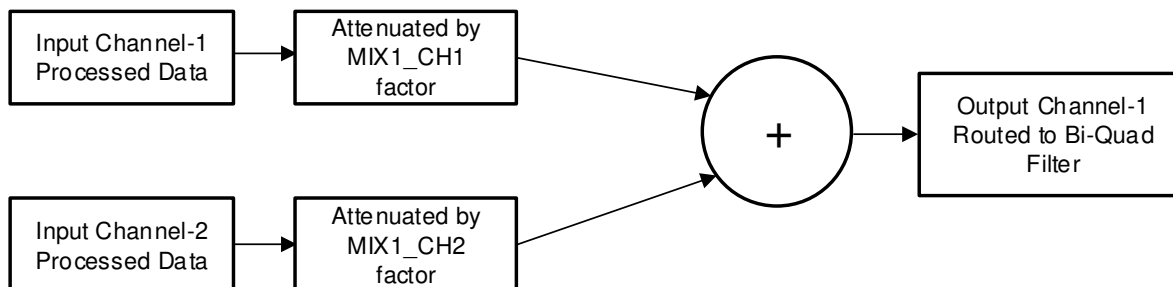
表 8-22. Decimation Filter Mode Selection for the Record Channel

P0_R107_D[5:4] : DECI_FILTER[1:0]	DECIMATION FILTER MODE SELECTION
00 (default)	Linear phase filters are used for the decimation
01	Low latency filters are used for the decimation
10	Ultra-low latency filters are used for the decimation
11	Reserved (do not use this setting)

8.3.6.7.1 Linear Phase Filters

The linear phase decimation filters are the default filters set by the device and can be used for all applications that require a perfect linear phase with zero-phase deviation within the pass-band specification of the filter. The filter performance specifications and various plots for all supported output sampling rates are listed in this section.

8.3.6.7.1.1 Sampling Rate: 7.35 kHz to 8 kHz

图 8-19 和 图 8-20 分别显示了一个采样率为 7.35 kHz 到 8 kHz 的 decimation 滤波器的幅度响应和通带纹波。表 8-23 列出了 7.35-kHz 到 8-kHz 采样率的 decimation 滤波器的规格。



图 8-19. Linear Phase Decimation Filter Magnitude Response



图 8-20. Linear Phase Decimation Filter Pass-Band Ripple

表 8-23. Linear Phase Decimation Filter Specifications

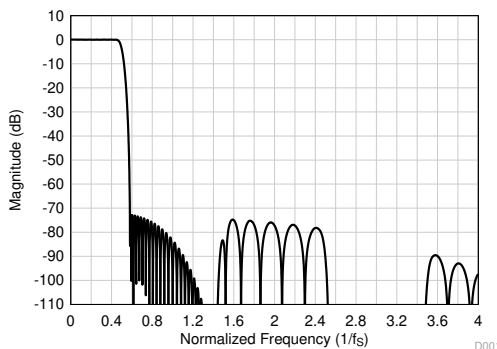
PARAMETER	TEST CONDITIONS	MIN	TYP	MAX	UNIT
Pass-band ripple	Frequency range is 0 to $0.454 \times f_s$	-0.05		0.05	dB
Stop-band attenuation	Frequency range is $0.58 \times f_s$ to $4 \times f_s$	72.7			dB
	Frequency range is $4 \times f_s$ onwards	81.2			
Group delay or latency	Frequency range is 0 to $0.454 \times f_s$		17.1		$1/f_s$

8.3.6.7.1.2 Sampling Rate: 14.7 kHz to 16 kHz

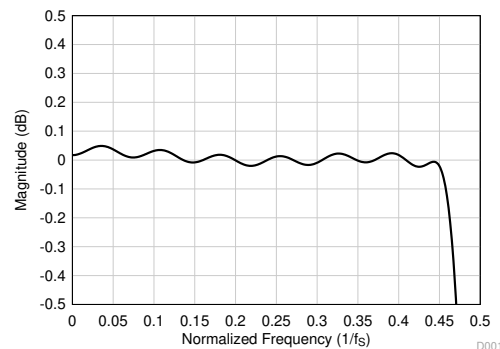
图 8-21 和 图 8-22 分别显示具有 14.7 kHz 到 16 kHz 采样率的衰减滤波器的幅频响应和通带纹波。表 8-24 列出了具有 14.7 kHz 到 16-kHz 采样率的衰减滤波器的规格。



表 8-24. Linear Phase Decimation Filter Specifications

PARAMETER	TEST CONDITIONS	MIN	TYP	MAX	UNIT
Pass-band ripple	Frequency range is 0 to $0.454 \times f_s$	-0.05		0.05	dB
Stop-band attenuation	Frequency range is $0.58 \times f_s$ to $4 \times f_s$	73.3			dB
	Frequency range is $4 \times f_s$ onwards	95.0			
Group delay or latency	Frequency range is 0 to $0.454 \times f_s$		15.7		$1/f_s$

8.3.6.7.1.3 Sampling Rate: 22.05 kHz to 24 kHz

图 8-23 和 图 8-24 分别显示具有 22.05 kHz 到 24 kHz 采样率的衰减滤波器的幅频响应和通带纹波。表 8-25 列出了具有 22.05-kHz 到 24-kHz 采样率的衰减滤波器的规格。

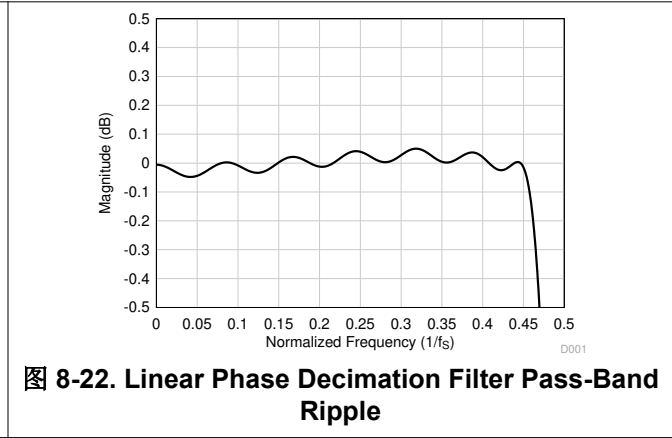
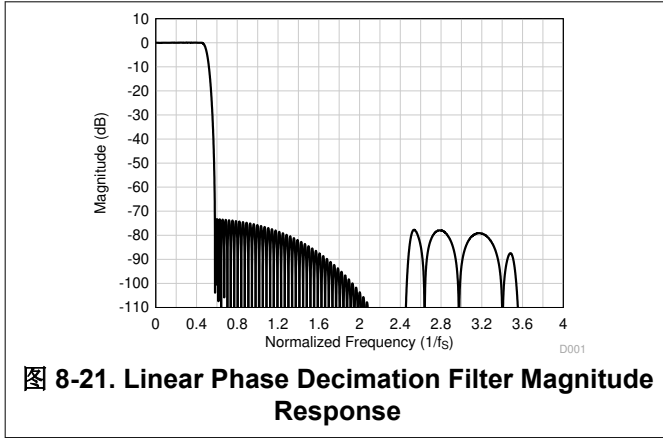

表 8-25. Linear Phase Decimation Filter Specifications

PARAMETER	TEST CONDITIONS	MIN	TYP	MAX	UNIT
Pass-band ripple	Frequency range is 0 to $0.454 \times f_s$	-0.05		0.05	dB
Stop-band attenuation	Frequency range is $0.58 \times f_s$ to $4 \times f_s$	73.0			dB
	Frequency range is $4 \times f_s$ onwards	96.4			

表 8-25. Linear Phase Decimation Filter Specifications (continued)

PARAMETER	TEST CONDITIONS	MIN	TYP	MAX	UNIT
Group delay or latency	Frequency range is 0 to $0.454 \times f_S$		16.6		$1/f_S$

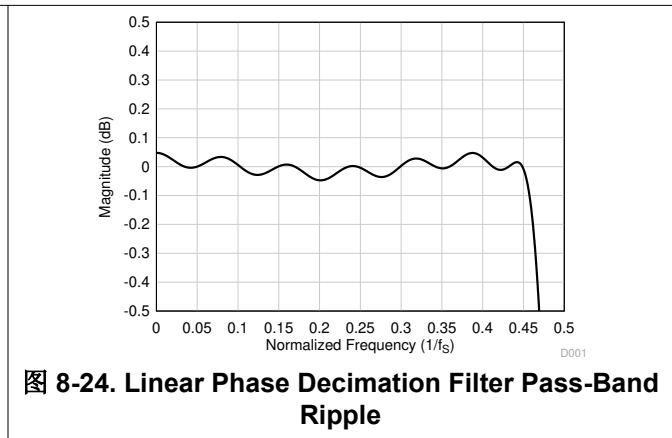
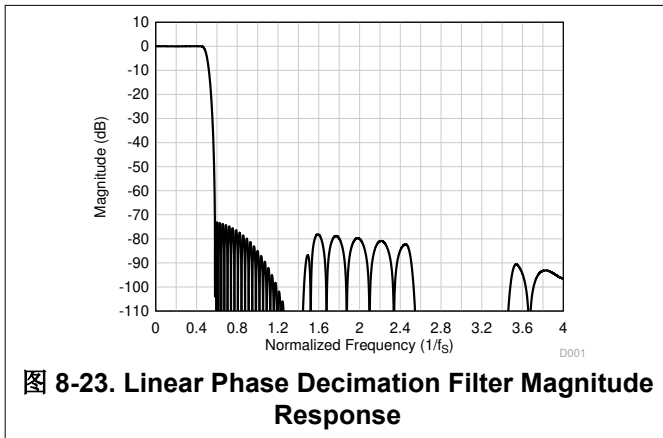
8.3.6.7.1.4 Sampling Rate: 29.4 kHz to 32 kHz

图 8-25 和 图 8-26 分别显示具有 29.4 kHz 到 32 kHz 采样率的衰减滤波器的幅频响应和通带纹波。表 8-26 列出了具有 29.4-kHz 到 32-kHz 采样率的衰减滤波器的规格。



图 8-25. Linear Phase Decimation Filter Magnitude Response



图 8-26. Linear Phase Decimation Filter Pass-Band Ripple

表 8-26. Linear Phase Decimation Filter Specifications

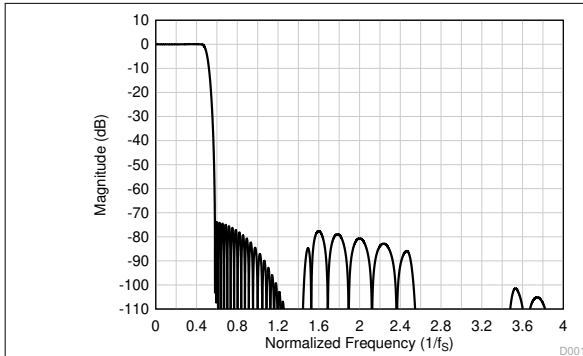
PARAMETER	TEST CONDITIONS	MIN	TYP	MAX	UNIT
Pass-band ripple	Frequency range is 0 to $0.454 \times f_S$	-0.05		0.05	dB
Stop-band attenuation	Frequency range is $0.58 \times f_S$ to $4 \times f_S$	73.7			dB
	Frequency range is $4 \times f_S$ onwards	107.2			
Group delay or latency	Frequency range is 0 to $0.454 \times f_S$		16.9		$1/f_S$

8.3.6.7.1.5 Sampling Rate: 44.1 kHz to 48 kHz

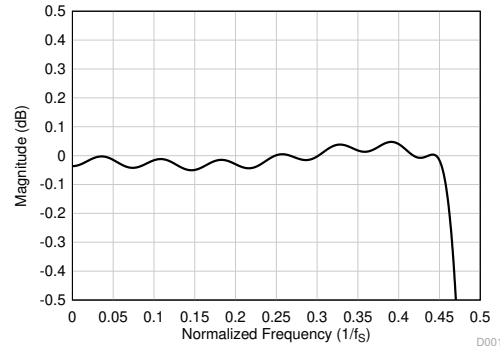
图 8-27 和 图 8-28 分别显示具有 44.1 kHz 到 48 kHz 采样率的衰减滤波器的幅频响应和通带纹波。表 8-27 列出了具有 44.1-kHz 到 48-kHz 采样率的衰减滤波器的规格。



图 8-27. Linear Phase Decimation Filter Magnitude Response



图 8-28. Linear Phase Decimation Filter Pass-Band Ripple

表 8-27. Linear Phase Decimation Filter Specifications

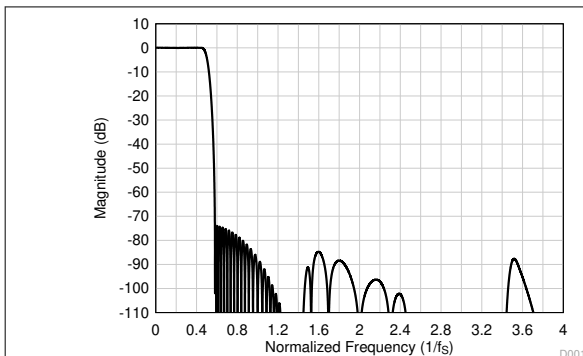
PARAMETER	TEST CONDITIONS	MIN	TYP	MAX	UNIT
Pass-band ripple	Frequency range is 0 to $0.454 \times f_S$	- 0.05		0.05	dB
Stop-band attenuation	Frequency range is $0.58 \times f_S$ to $4 \times f_S$	73.8			dB
	Frequency range is $4 \times f_S$ onwards	98.1			
Group delay or latency	Frequency range is 0 to $0.454 \times f_S$		17.1		$1/f_S$

8.3.6.7.1.6 Sampling Rate: 88.2 kHz to 96 kHz

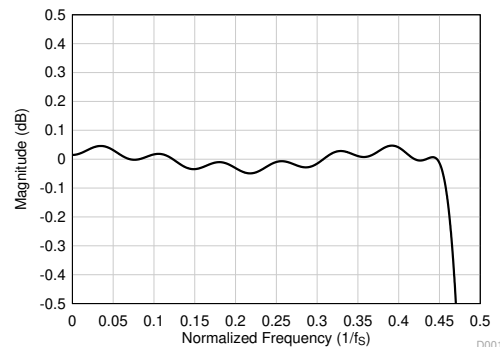
图 8-29 和 图 8-30 分别显示了一个采样率为 88.2 kHz 到 96 kHz 的衰减滤波器的幅度和通带纹波。表 8-28 列出了具有 88.2-kHz 到 96-kHz 采样率的衰减滤波器的规格。



表 8-28. Linear Phase Decimation Filter Specifications

PARAMETER	TEST CONDITIONS	MIN	TYP	MAX	UNIT
Pass-band ripple	Frequency range is 0 to $0.454 \times f_S$	- 0.05		0.05	dB
Stop-band attenuation	Frequency range is $0.58 \times f_S$ to $4 \times f_S$	73.6			dB
	Frequency range is $4 \times f_S$ onwards	97.9			
Group delay or latency	Frequency range is 0 to $0.454 \times f_S$		17.1		$1/f_S$

8.3.6.7.1.7 Sampling Rate: 176.4 kHz to 192 kHz

图 8-31 和 图 8-32 分别显示了一个采样率为 176.4 kHz 到 192 kHz 的衰减滤波器的幅度和通带纹波。表 8-29 列出了具有 176.4-kHz 到 192-kHz 采样率的衰减滤波器的规格。

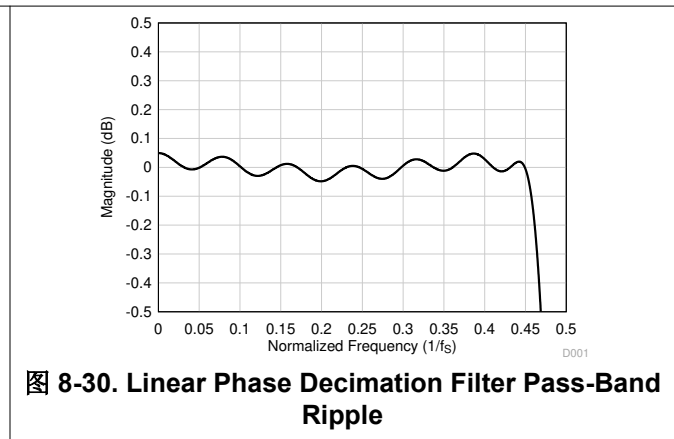
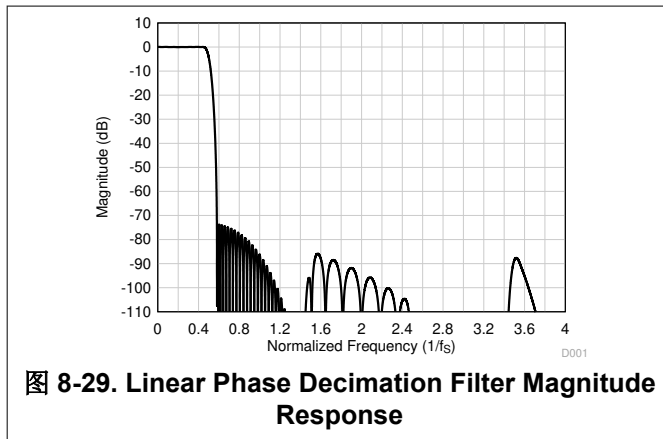

图 8-31. Linear Phase Decimation Filter Magnitude Response



图 8-32. Linear Phase Decimation Filter Pass-Band Ripple

表 8-29. Linear Phase Decimation Filter Specifications

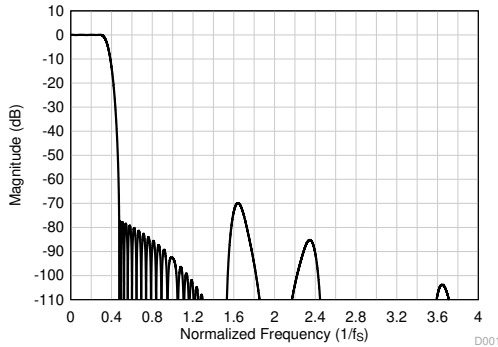
PARAMETER	TEST CONDITIONS	MIN	TYP	MAX	UNIT
Pass-band ripple	Frequency range is 0 to $0.3 \times f_s$	-0.05		0.05	dB
Stop-band attenuation	Frequency range is $0.473 \times f_s$ to $4 \times f_s$	70.0			
	Frequency range is $4 \times f_s$ onwards	111.0			dB
Group delay or latency	Frequency range is 0 to $0.3 \times f_s$		11.9		

8.3.6.7.1.8 Sampling Rate: 352.8 kHz to 384 kHz

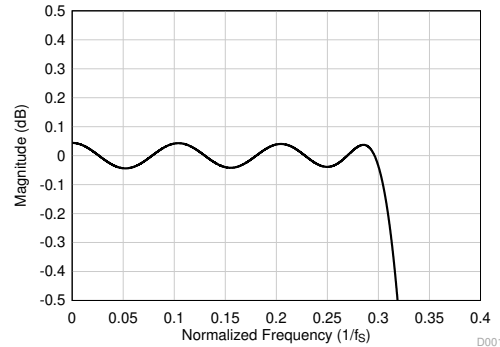
图 8-33 和 图 8-34 分别显示具有 352.8 kHz 到 384 kHz 采样率的衰减滤波器的幅度响应和通带纹波。表 8-30 列出了具有 352.8-kHz 到 384-kHz 采样率的衰减滤波器的规格。



图 8-33. Linear Phase Decimation Filter Magnitude Response



图 8-34. Linear Phase Decimation Filter Pass-Band Ripple

表 8-30. Linear Phase Decimation Filter Specifications

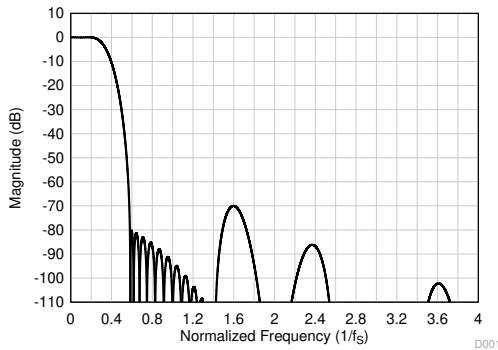
PARAMETER	TEST CONDITIONS	MIN	TYP	MAX	UNIT
Pass-band ripple	Frequency range is 0 to $0.212 \times f_s$	-0.05		0.05	dB
Stop-band attenuation	Frequency range is $0.58 \times f_s$ to $4 \times f_s$	70.0			
	Frequency range is $4 \times f_s$ onwards	108.8			dB
Group delay or latency	Frequency range is 0 to $0.212 \times f_s$		7.2		

8.3.6.7.1.9 Sampling Rate: 705.6 kHz to 768 kHz

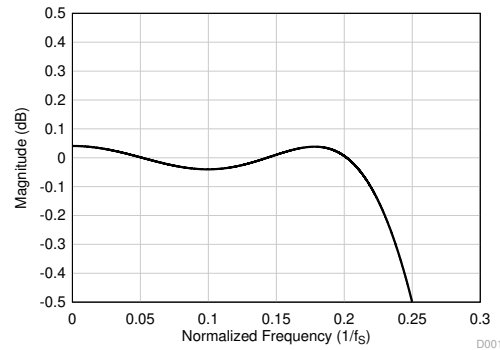
图 8-35 和 图 8-36 分别显示具有 705.6 kHz 到 768 kHz 采样率的衰减滤波器的幅度响应和通带纹波。表 8-31 列出了具有 705.6-kHz 到 768-kHz 采样率的衰减滤波器的规格。



图 8-35. Linear Phase Decimation Filter Magnitude Response



图 8-36. Linear Phase Decimation Filter Pass-Band Ripple

表 8-31. Linear Phase Decimation Filter Specifications

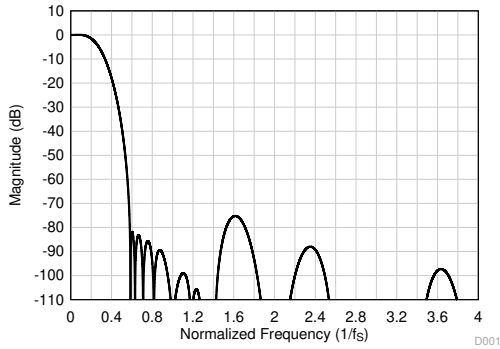
PARAMETER	TEST CONDITIONS	MIN	TYP	MAX	UNIT
Pass-band ripple	Frequency range is 0 to $0.113 \times f_s$	-0.05		0.05	dB
Stop-band attenuation	Frequency range is $0.58 \times f_s$ to $2 \times f_s$	75.0			
	Frequency range is $2 \times f_s$ onwards	88.0			
Group delay or latency	Frequency range is 0 to $0.113 \times f_s$		5.9		$1/f_s$

8.3.6.7.2 Low-Latency Filters

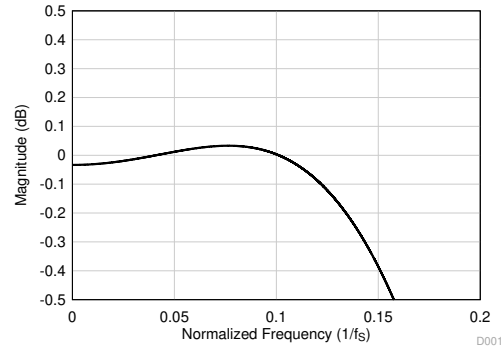
For applications where low latency with minimal phase deviation (within the audio band) is critical, the low-latency decimation filters on the PCM6120-Q1 can be used. The device supports these filters with a group delay of approximately seven samples with an almost linear phase response within the $0.365 \times f_s$ frequency band. This section provides the filter performance specifications and various plots for all supported output sampling rates for the low-latency filters.

8.3.6.7.2.1 Sampling Rate: 14.7 kHz to 16 kHz

图 8-37 shows the magnitude response and 图 8-38 shows the pass-band ripple and phase deviation for a decimation filter with a sampling rate of 14.7 kHz to 16 kHz. 表 8-32 lists the specifications for a decimation filter with a 14.7-kHz to 16-kHz sampling rate.



表 8-32. Low-Latency Decimation Filter Specifications

PARAMETER	TEST CONDITIONS	MIN	TYP	MAX	UNIT
Pass-band ripple	Frequency range is 0 to $0.451 \times f_s$	- 0.05		0.05	dB
Stop-band attenuation	Frequency range is $0.61 \times f_s$ onwards	87.3			dB
Group delay or latency	Frequency range is 0 to $0.363 \times f_s$		7.6		$1/f_s$
Group delay deviation	Frequency range is 0 to $0.363 \times f_s$	- 0.022		0.022	$1/f_s$
Phase deviation	Frequency range is 0 to $0.363 \times f_s$	- 0.21		0.25	Degrees

8.3.6.7.2.2 Sampling Rate: 22.05 kHz to 24 kHz

图 8-39 shows the magnitude response and 图 8-40 shows the pass-band ripple and phase deviation for a decimation filter with a sampling rate of 22.05 kHz to 24 kHz. 表 8-33 lists the specifications for a decimation filter with a 22.05-kHz to 24-kHz sampling rate.

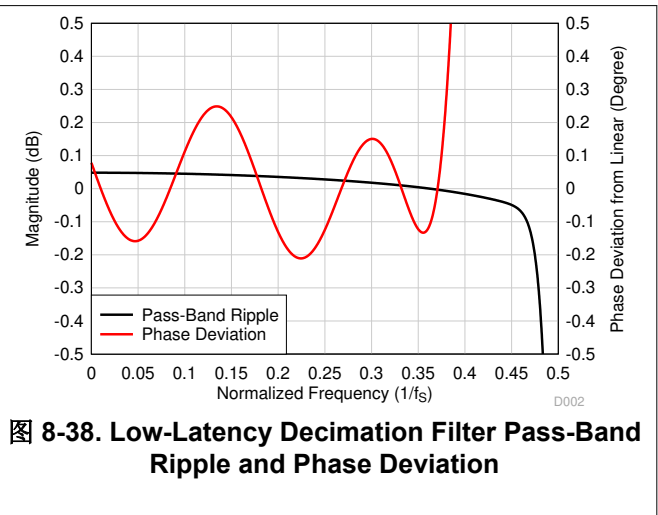
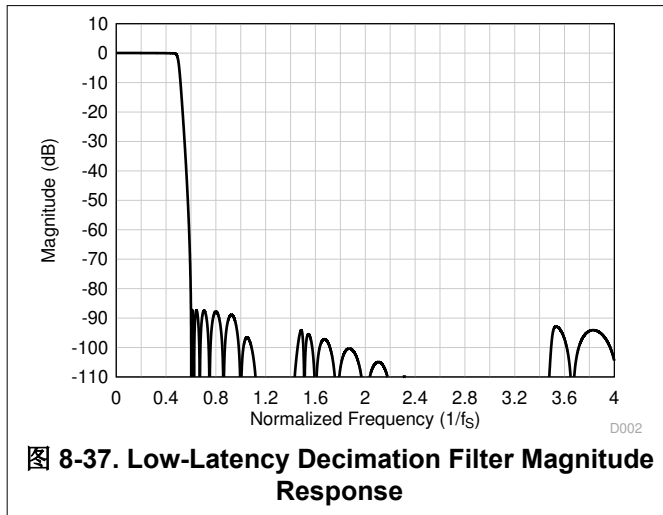

表 8-33. Low-Latency Decimation Filter Specifications

PARAMETER	TEST CONDITIONS	MIN	TYP	MAX	UNIT
Pass-band ripple	Frequency range is 0 to $0.459 \times f_s$	- 0.01		0.01	dB
Stop-band attenuation	Frequency range is $0.6 \times f_s$ onwards	87.2			dB
Group delay or latency	Frequency range is 0 to $0.365 \times f_s$		7.5		$1/f_s$
Group delay deviation	Frequency range is 0 to $0.365 \times f_s$	- 0.026		0.026	$1/f_s$
Phase deviation	Frequency range is 0 to $0.365 \times f_s$	- 0.26		0.30	Degrees

8.3.6.7.2.3 Sampling Rate: 29.4 kHz to 32 kHz

图 8-41 shows the magnitude response and 图 8-42 shows the pass-band ripple and phase deviation for a decimation filter with a sampling rate of 29.4 kHz to 32 kHz. 表 8-34 lists the specifications for a decimation filter with a 29.4-kHz to 32-kHz sampling rate.

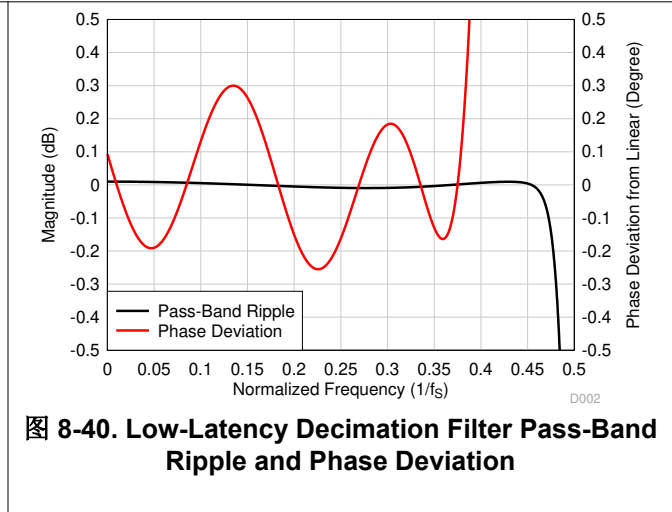
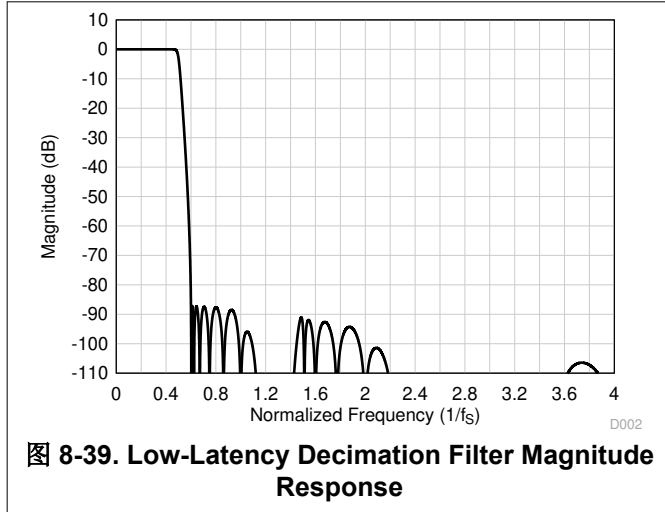

表 8-34. Low-Latency Decimation Filter Specifications

PARAMETER	TEST CONDITIONS	MIN	TYP	MAX	UNIT
Pass-band ripple	Frequency range is 0 to $0.457 \times f_S$	- 0.04		0.04	dB
Stop-band attenuation	Frequency range is $0.6 \times f_S$ onwards	88.3			dB
Group delay or latency	Frequency range is 0 to $0.368 \times f_S$		8.7		$1/f_S$
Group delay deviation	Frequency range is 0 to $0.368 \times f_S$	- 0.026		0.026	$1/f_S$
Phase deviation	Frequency range is 0 to $0.368 \times f_S$	- 0.26		0.31	Degrees

8.3.6.7.2.4 Sampling Rate: 44.1 kHz to 48 kHz

图 8-43 shows the magnitude response and 图 8-44 shows the pass-band ripple and phase deviation for a decimation filter with a sampling rate of 44.1 kHz to 48 kHz. 表 8-35 lists the specifications for a decimation filter with a 44.1-kHz to 48-kHz sampling rate.

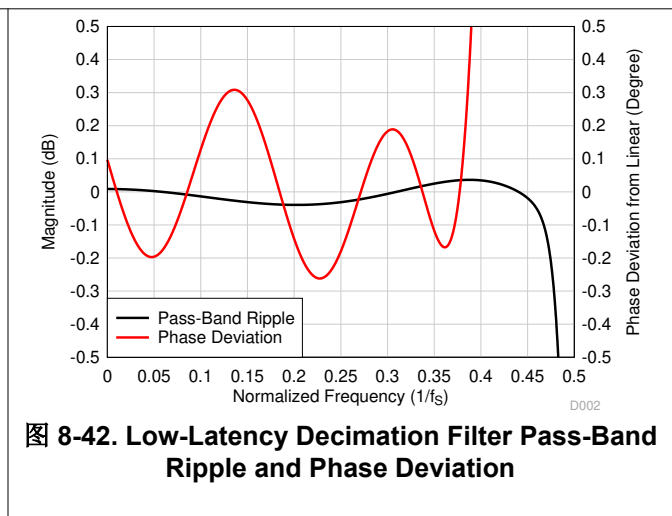
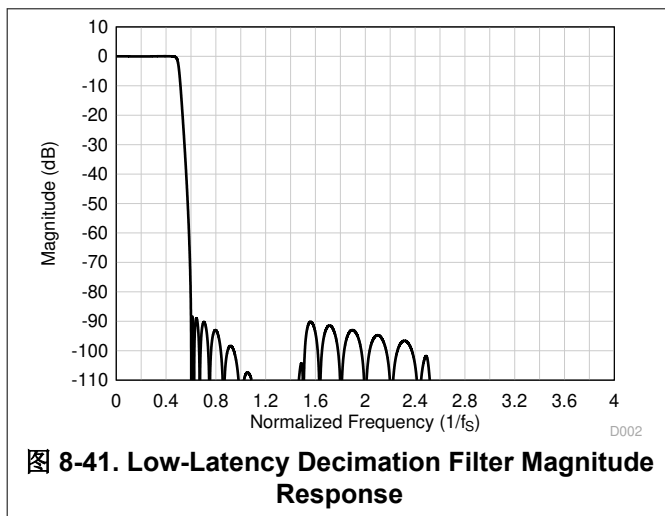

表 8-35. Low-Latency Decimation Filter Specifications

PARAMETER	TEST CONDITIONS	MIN	TYP	MAX	UNIT
Pass-band ripple	Frequency range is 0 to $0.452 \times f_S$	- 0.015		0.015	dB
Stop-band attenuation	Frequency range is $0.6 \times f_S$ onwards	86.4			dB
Group delay or latency	Frequency range is 0 to $0.365 \times f_S$		7.7		$1/f_S$
Group delay deviation	Frequency range is 0 to $0.365 \times f_S$	- 0.027		0.027	$1/f_S$
Phase deviation	Frequency range is 0 to $0.365 \times f_S$	- 0.25		0.30	Degrees

8.3.6.7.2.5 Sampling Rate: 88.2 kHz to 96 kHz

图 8-45 shows the magnitude response and 图 8-46 shows the pass-band ripple and phase deviation for a decimation filter with a sampling rate of 88.2 kHz to 96 kHz. 表 8-36 lists the specifications for a decimation filter with an 88.2-kHz to 96-kHz sampling rate.

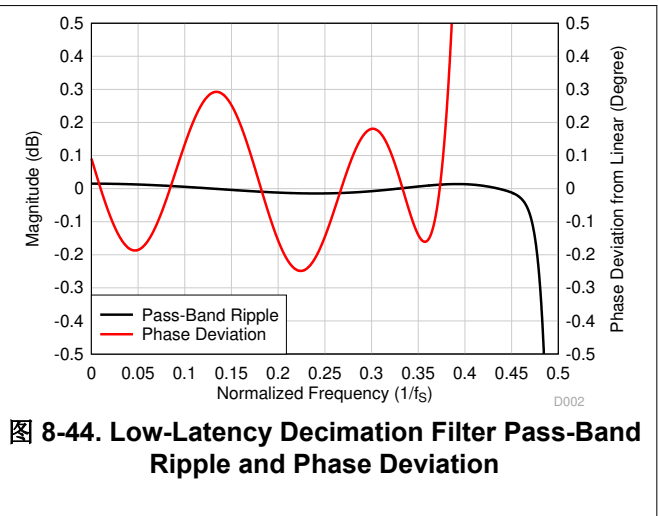
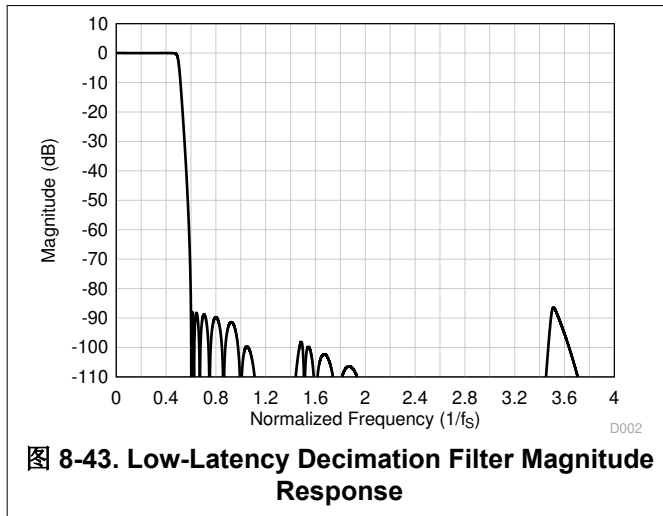

表 8-36. Low-Latency Decimation Filter Specifications

PARAMETER	TEST CONDITIONS	MIN	TYP	MAX	UNIT
Pass-band ripple	Frequency range is 0 to $0.466 \times f_s$	- 0.04		0.04	dB
Stop-band attenuation	Frequency range is $0.6 \times f_s$ onwards	86.3			dB
Group delay or latency	Frequency range is 0 to $0.365 \times f_s$		7.7		$1/f_s$
Group delay deviation	Frequency range is 0 to $0.365 \times f_s$	- 0.027		0.027	$1/f_s$
Phase deviation	Frequency range is 0 to $0.365 \times f_s$	- 0.26		0.30	Degrees

8.3.6.7.2.6 Sampling Rate: 176.4 kHz to 192 kHz

图 8-47 shows the magnitude response and 图 8-48 shows the pass-band ripple and phase deviation for a decimation filter with a sampling rate of 176.4 kHz to 192 kHz. 表 8-37 lists the specifications for a decimation filter with a 176.4-kHz to 192-kHz sampling rate.

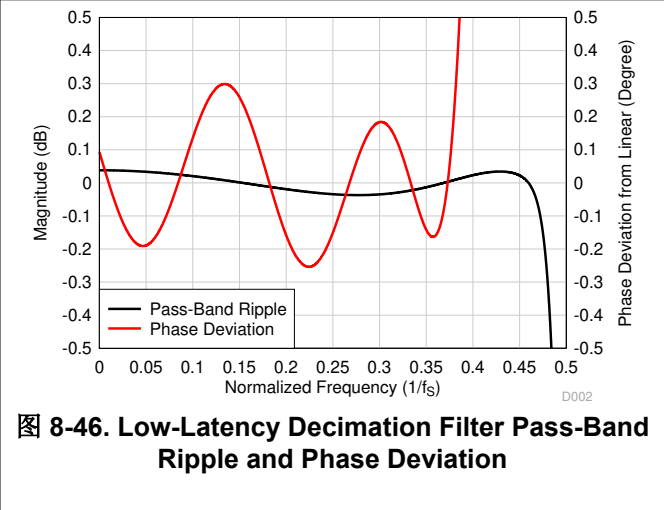
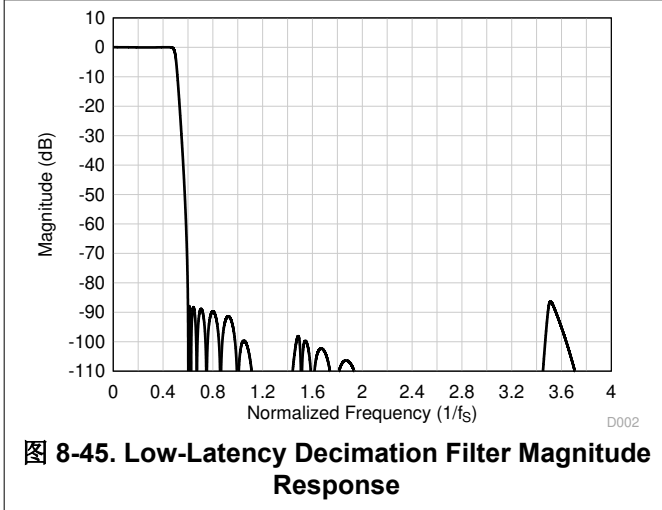

表 8-37. Low-Latency Decimation Filter Specifications

PARAMETER	TEST CONDITIONS	MIN	TYP	MAX	UNIT
Pass-band ripple	Frequency range is 0 to $463 \times f_S$	- 0.03		0.03	dB
Stop-band attenuation	Frequency range is $0.6 \times f_S$ onwards	85.6			dB
Group delay or latency	Frequency range is 0 to $0.365 \times f_S$		7.7		$1/f_S$
Group delay deviation	Frequency range is 0 to $0.365 \times f_S$	- 0.027		0.027	$1/f_S$
Phase deviation	Frequency range is 0 to $0.365 \times f_S$	- 0.26		0.30	Degrees

8.3.6.7.3 Ultra-Low Latency Filters

For applications where ultra-low latency (within the audio band) is critical, the ultra-low latency decimation filters on the PCM6120-Q1 can be used. The device supports these filters with a group delay of approximately four samples with an almost linear phase response within the $0.325 \times f_S$ frequency band. This section provides the filter performance specifications and various plots for all supported output sampling rates for the ultra-low latency filters.

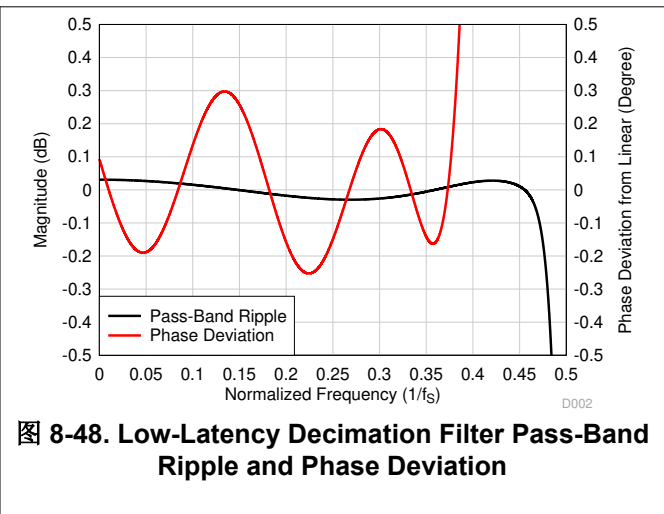
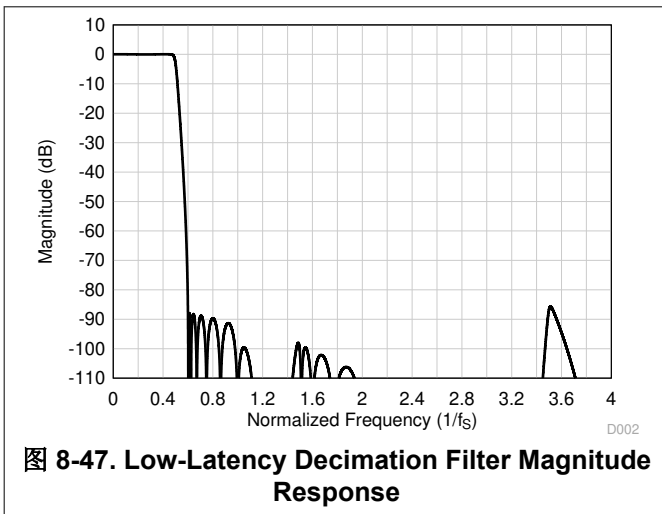
8.3.6.7.3.1 Sampling Rate: 14.7 kHz to 16 kHz

图 8-49 shows the magnitude response and 图 8-50 shows the pass-band ripple and phase deviation for a decimation filter with a sampling rate of 14.7 kHz to 16 kHz. 表 8-38 lists the specifications for a decimation filter with a 14.7-kHz to 16-kHz sampling rate.



表 8-38. Ultra-Low-Latency Decimation Filter Specifications

PARAMETER	TEST CONDITIONS	MIN	TYP	MAX	UNIT
Pass-band ripple	Frequency range is 0 to $0.45 \times f_S$	- 0.05		0.05	dB
Stop-band attenuation	Frequency range is $0.6 \times f_S$ onwards	87.2			dB
Group delay or latency	Frequency range is 0 to $0.325 \times f_S$		4.3		$1/f_S$
Group delay deviation	Frequency range is 0 to $0.325 \times f_S$	- 0.512		0.512	$1/f_S$
Phase deviation	Frequency range is 0 to $0.325 \times f_S$	- 10.0		14.2	Degrees

8.3.6.7.3.2 Sampling Rate: 22.05 kHz to 24 kHz

图 8-51 shows the magnitude response and 图 8-52 shows the pass-band ripple and phase deviation for a decimation filter with a sampling rate of 22.05 kHz to 24 kHz. 表 8-39 lists the specifications for a decimation filter with a 22.05-kHz to 24-kHz sampling rate.

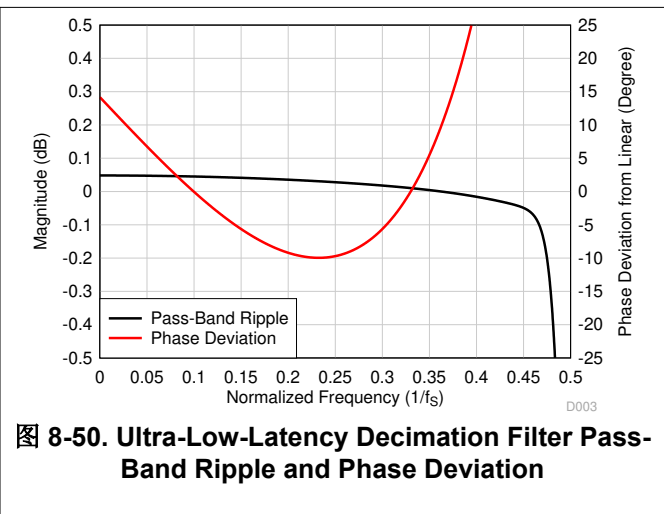
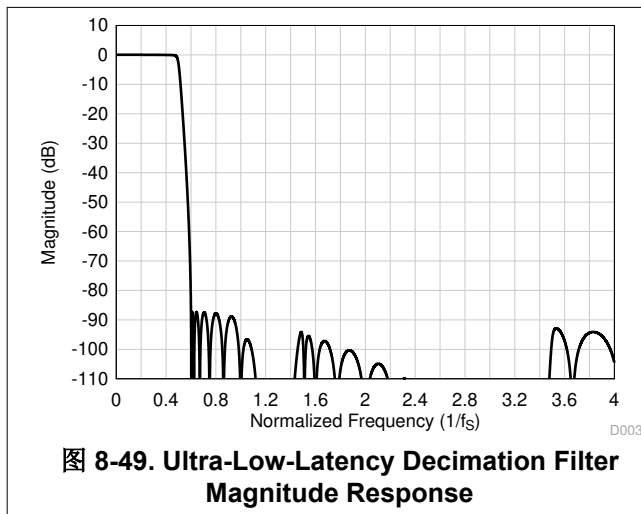

表 8-39. Ultra-Low-Latency Decimation Filter Specifications

PARAMETER	TEST CONDITIONS	MIN	TYP	MAX	UNIT
Pass-band ripple	Frequency range is 0 to $0.46 \times f_s$	- 0.01		0.01	dB
Stop-band attenuation	Frequency range is $0.6 \times f_s$ onwards	87.1			dB
Group delay or latency	Frequency range is 0 to $0.325 \times f_s$		4.1		$1/f_s$
Group delay deviation	Frequency range is 0 to $0.325 \times f_s$	- 0.514		0.514	$1/f_s$
Phase deviation	Frequency range is 0 to $0.325 \times f_s$	- 10.0		14.3	Degrees

8.3.6.7.3.3 Sampling Rate: 29.4 kHz to 32 kHz

图 8-53 shows the magnitude response and 图 8-54 shows the pass-band ripple and phase deviation for a decimation filter with a sampling rate of 29.4 kHz to 32 kHz. 表 8-40 lists the specifications for a decimation filter with a 29.4-kHz to 32-kHz sampling rate.

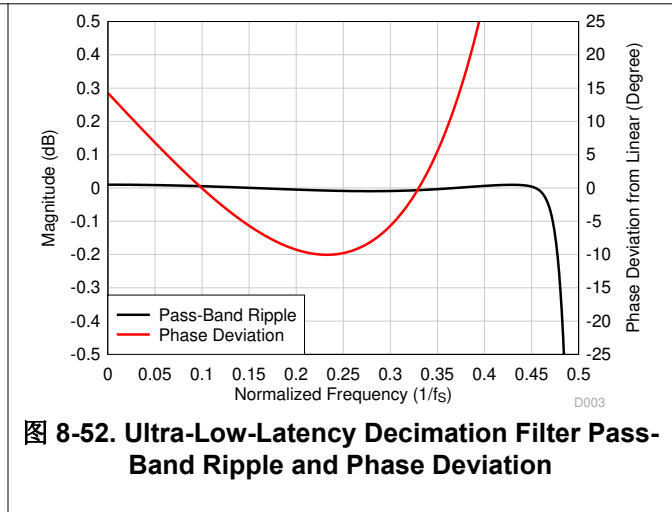
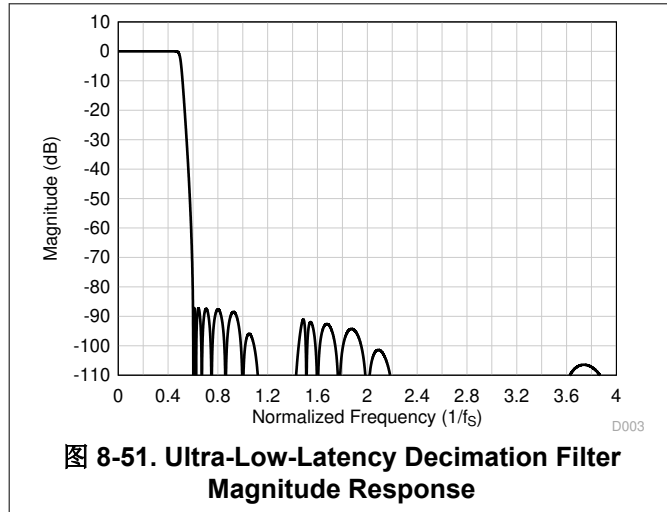

表 8-40. Ultra-Low-Latency Decimation Filter Specifications

PARAMETER	TEST CONDITIONS	MIN	TYP	MAX	UNIT
Pass-band ripple	Frequency range is 0 to $0.457 \times f_S$	- 0.04		0.04	dB
Stop-band attenuation	Frequency range is $0.6 \times f_S$ onwards	88.3			dB
Group delay or latency	Frequency range is 0 to $0.325 \times f_S$		5.2		$1/f_S$
Group delay deviation	Frequency range is 0 to $0.325 \times f_S$	- 0.492		0.492	$1/f_S$
Phase deviation	Frequency range is 0 to $0.325 \times f_S$	- 9.5		13.5	Degrees

8.3.6.7.3.4 Sampling Rate: 44.1 kHz to 48 kHz

图 8-55 显示了幅度响应，图 8-56 显示了通带纹波和相位偏差，用于采样率为 44.1 kHz 到 48 kHz 的 decimation filter。表 8-41 列出了采样率为 44.1-kHz 到 48-kHz 的 decimation filter 的规格。

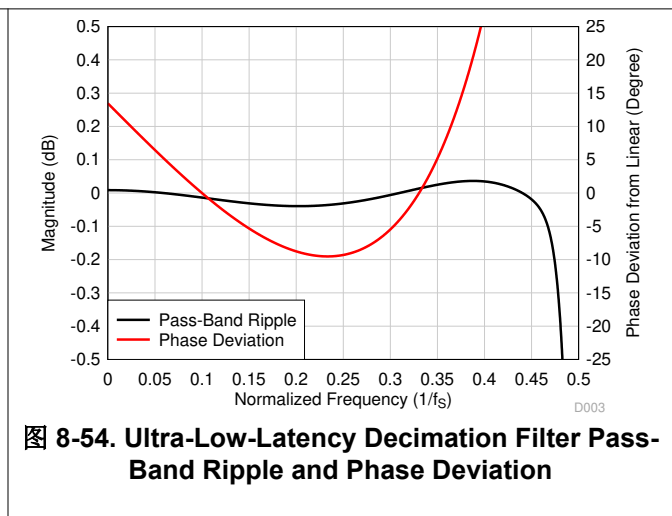
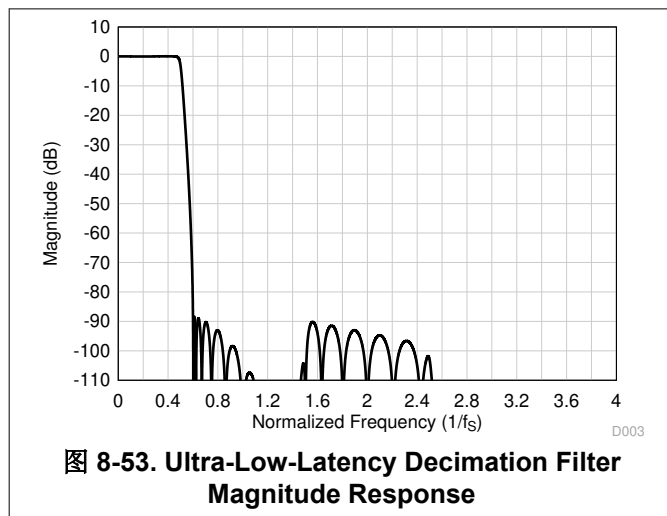

表 8-41. Ultra-Low-Latency Decimation Filter Specifications

PARAMETER	TEST CONDITIONS	MIN	TYP	MAX	UNIT
Pass-band ripple	Frequency range is 0 to $0.452 \times f_S$	- 0.015		0.015	dB
Stop-band attenuation	Frequency range is $0.6 \times f_S$ onwards	86.4			dB
Group delay or latency	Frequency range is 0 to $0.325 \times f_S$		4.1		$1/f_S$
Group delay deviation	Frequency range is 0 to $0.325 \times f_S$	- 0.525		0.525	$1/f_S$
Phase deviation	Frequency range is 0 to $0.325 \times f_S$	- 10.3		14.5	Degrees

8.3.6.7.3.5 Sampling Rate: 88.2 kHz to 96 kHz

图 8-57 shows the magnitude response and 图 8-58 shows the pass-band ripple and phase deviation for a decimation filter with a sampling rate of 88.2 kHz to 96 kHz. 表 8-42 lists the specifications for a decimation filter with an 88.2-kHz to 96-kHz sampling rate.

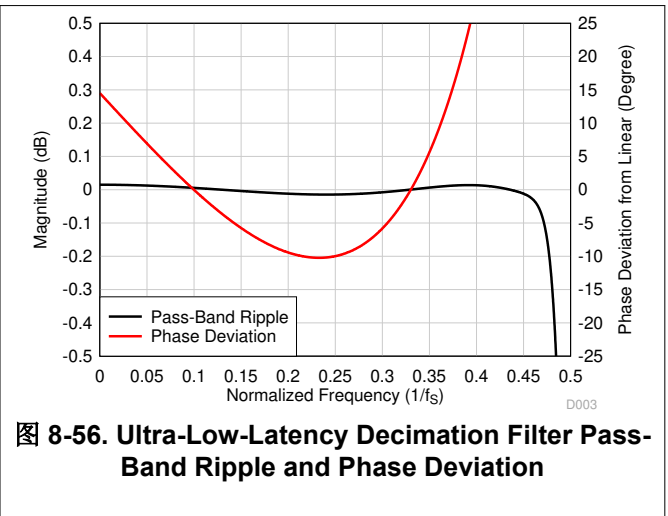
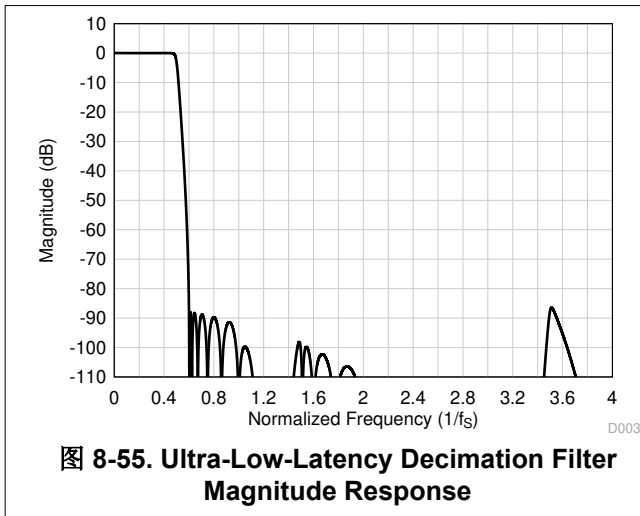

表 8-42. Ultra-Low-Latency Decimation Filter Specifications

PARAMETER	TEST CONDITIONS	MIN	TYP	MAX	UNIT
Pass-band ripple	Frequency range is 0 to $0.466 \times f_s$	- 0.04		0.04	dB
Stop-band attenuation	Frequency range is $0.6 \times f_s$ onwards	86.3			dB
Group delay or latency	Frequency range is 0 to $0.1625 \times f_s$		3.7		$1/f_s$
Group delay deviation	Frequency range is 0 to $0.1625 \times f_s$	- 0.091		0.091	$1/f_s$
Phase deviation	Frequency range is 0 to $0.1625 \times f_s$	- 0.86		1.30	Degrees

8.3.6.7.3.6 Sampling Rate: 176.4 kHz to 192 kHz

图 8-59 shows the magnitude response and 图 8-60 shows the pass-band ripple and phase deviation for a decimation filter with a sampling rate of 176.4 kHz to 192 kHz. 表 8-43 lists the specifications for a decimation filter with a 176.4-kHz to 192-kHz sampling rate.

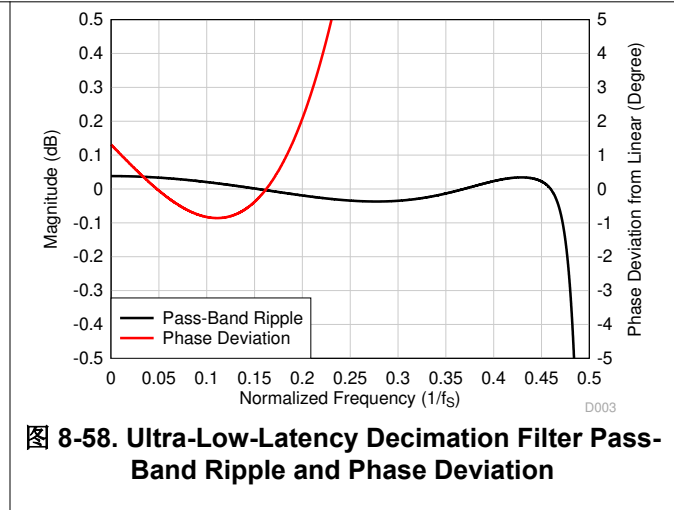
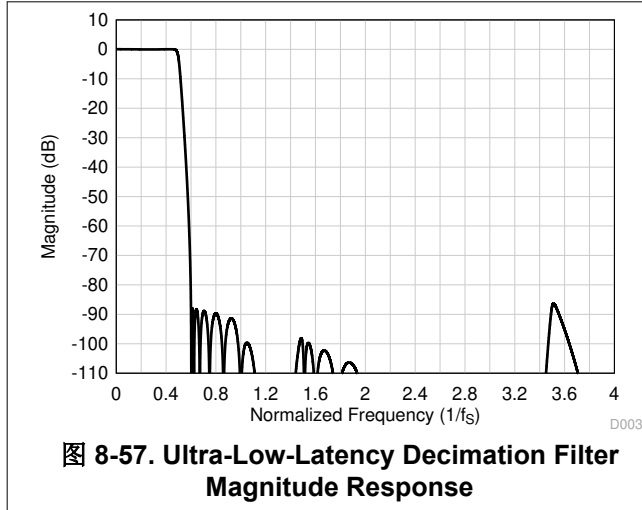

表 8-43. Ultra-Low-Latency Decimation Filter Specifications

PARAMETER	TEST CONDITIONS	MIN	TYP	MAX	UNIT
Pass-band ripple	Frequency range is 0 to $0.463 \times f_S$	- 0.03		0.03	dB
Stop-band attenuation	Frequency range is $0.6 \times f_S$ onwards	85.6			dB
Group delay or latency	Frequency range is 0 to $0.085 \times f_S$		3.7		$1/f_S$
Group delay deviation	Frequency range is 0 to $0.085 \times f_S$	- 0.024		0.024	$1/f_S$
Phase deviation	Frequency range is 0 to $0.085 \times f_S$	- 0.12		0.18	Degrees

8.3.6.7.3.7 Sampling Rate: 352.8 kHz to 384 kHz

图 8-61 shows the magnitude response and 图 8-62 shows the pass-band ripple and phase deviation for a decimation filter with a sampling rate of 352.8 kHz to 384 kHz. 表 8-44 lists the specifications for a decimation filter with a 352.8-kHz to 384-kHz sampling rate.

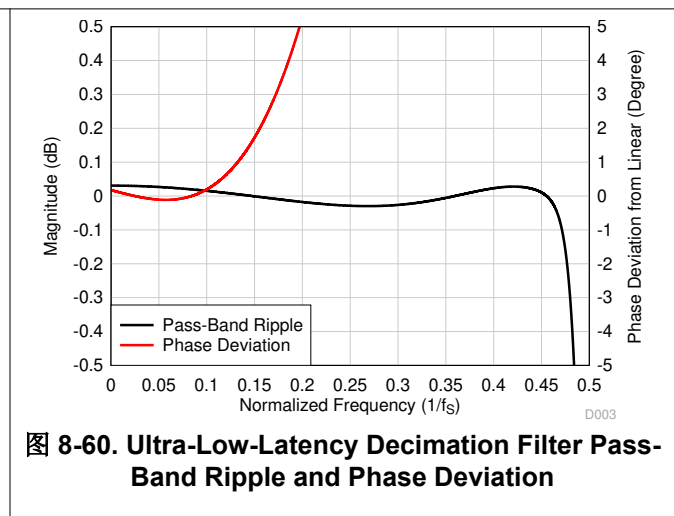
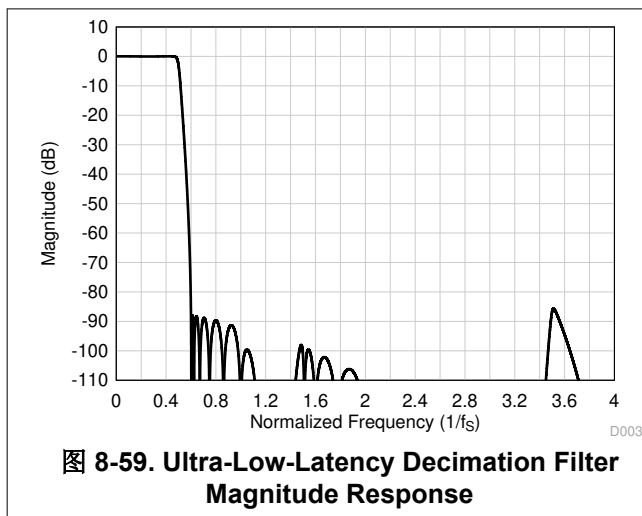

表 8-44. Ultra-Low-Latency Decimation Filter Specifications

PARAMETER	TEST CONDITIONS	MIN	TYP	MAX	UNIT
Pass-band ripple	Frequency range is 0 to $0.1 \times f_S$	- 0.04		0.01	dB
Stop-band attenuation	Frequency range is $0.56 \times f_S$ onwards	70.1			dB
Group delay or latency	Frequency range is 0 to $0.157 \times f_S$		4.1		$1/f_S$
Group delay deviation	Frequency range is 0 to $0.157 \times f_S$	- 0.18		0.18	$1/f_S$
Phase deviation	Frequency range is 0 to $0.157 \times f_S$	- 0.85		2.07	Degrees

8.3.7 Dynamic Range Enhancer (DRE)

The device integrates an ultra-low noise front-end PGA with 123-dB dynamic range performance with a low-noise, low-distortion, multibit delta-sigma ($\Delta\Sigma$) ADC with a 113-dB dynamic range. The dynamic range enhancer (DRE) is a digitally assisted algorithm to boost the overall channel performance. The DRE monitors the incoming signal amplitude and accordingly adjusts the internal PGA gain automatically. The DRE achieves a complete-channel dynamic range as high as 123 dB. At a system level, the DRE scheme enables far-field, high-fidelity recording of audio signals in very quiet environments and low-distortion recording in loud environments.

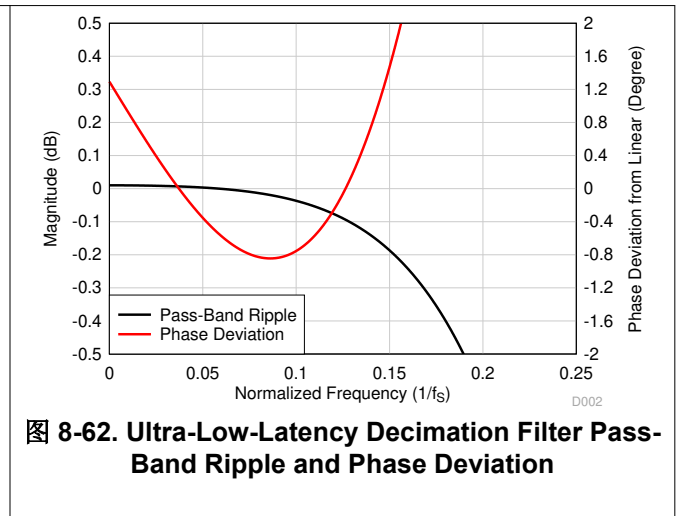
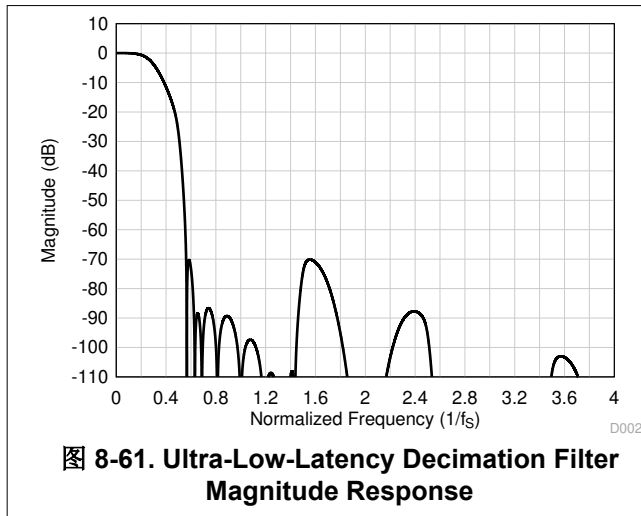
This algorithm is implemented with very low latency and all signal chain blocks are designed to minimize any audible artifacts that may occur resulting from dynamic gain modulation. Additionally, the host can configure the target signal threshold level at which the DRE is triggered by setting the appropriate value for the DRE_LVL[3:0] (P0_R109[7:4]) register bits. The DRE_LVL default level is set to -54 dB and TI recommends setting the DRE_LVL value lower than -30 dB to maximize the benefit of the DRE in real-world applications and to minimize any audible artifacts. [表 8-45](#) lists the DRE_LVL configuration settings.

表 8-45. DRE Trigger Threshold Level Programmable Settings

P0_R109_D[7:4] : DRE_LVL[3:0]	DRE TRIGGER THRESHOLD LEVEL
0000	The DRE trigger threshold is the -12-dB input signal level
0001	The DRE trigger threshold is the -18-dB input signal level
0010	The DRE trigger threshold is the -24-dB input signal level
...	...
0111 (default)	The DRE trigger threshold is the -54-dB input signal level
...	...
1001	The DRE trigger threshold is the -66-dB input signal level
1010 to 1111	Reserved (do not use these settings)

The DRE gain range can be dynamically modulated by using the DRE_MAXGAIN[3:0] (P0_R109[3:0]) register bits. The DRE_MAXGAIN default value is set to 24 dB, and the DRE_MAXGAIN value is recommended to be set lower than 24 dB to maximize the benefit of the DRE in real-world applications and to minimize any audible artifacts. [表 8-46](#) lists the DRE_MAXGAIN configuration settings.

表 8-46. DRE Maximum Gain Programmable Settings

P0_R109_D[3:0] : DRE_MAXGAIN[3:0]	DRE MAXIMUM GAIN ALLOWED
0000	The DRE maximum gain allowed is 2 dB
0001	The DRE maximum gain allowed is 4 dB
0010	The DRE maximum gain allowed is 6 dB
...	...
1011 (default)	The DRE maximum gain allowed is 24 dB
...	...
1110	The DRE maximum gain allowed is 30 dB
1111	Reserved (do not use this setting)

The DRE scheme is only supported for analog microphone recording channels with an AC-coupled input for best dynamic range performance. The DRE scheme can be independently enabled or disabled for each channel using the CH1_DREEN (P0_R60_D0) and CH2_DREEN (P0_R65_D0) register bits. For a DC-coupled input, the DRE scheme can be used with limited DRE_MAXGAIN depending on the DC differential input common-mode offset.

The DRE configuration registers should be changed only before Power Up of the device. Enabling the DRE for processing increases the power consumption of the device because of increased signal processing. Therefore, disable the DRE for low-power critical applications. Furthermore, the DRE is not supported for output sample rates greater than 192 kHz.

8.3.8 Dynamic Range Compressor (DRC)

The device integrates a dynamic range compressor (DRC) to amplify low-level signals and limits the maximum signal amplitude at the output. This algorithm is implemented with very low latency and all signal chain blocks are designed to minimize any audible artifacts that may occur resulting from dynamic gain modulation. The host can configure the target signal threshold level at which the DRC is triggered by setting the appropriate value for the DRE_LVL[3:0] (P0_R109[7:4]) register bits. [表 8-47](#) lists the DRE_LVL configuration settings.

表 8-47. DRC Trigger Threshold Level Programmable Settings

P0_R109_D[7:4] : DRE_LVL[3:0]	DRC TRIGGER THRESHOLD LEVEL
0000	The DRC trigger threshold is the -12-dB input signal level
0001	The DRC trigger threshold is the -18-dB input signal level
0010	The DRC trigger threshold is the -24-dB input signal level
...	...
0111 (default)	The DRC trigger threshold is the -54-dB input signal level
...	...
1001	The DRC trigger threshold is the -66-dB input signal level
1010 to 1111	Reserved (do not use these settings)

The DRC gain range can be dynamically modulated by using the DRE_MAXGAIN[3:0] (P0_R109[3:0]) register bits. [表 8-48](#) lists the DRE_MAXGAIN configuration settings.

表 8-48. DRC Maximum Gain Programmable Settings

P0_R109_D[3:0] : DRE_MAXGAIN[3:0]	DRC MAXIMUM GAIN ALLOWED
0000	The DRC maximum gain allowed is 2 dB
0001	The DRC maximum gain allowed is 4 dB
0010	The DRC maximum gain allowed is 6 dB
...	...
1011 (default)	The DRC maximum gain allowed is 24 dB
...	...
1110	The DRC maximum gain allowed is 30 dB
1111	Reserved (do not use this setting)

The DRC scheme is only supported for analog microphone recording channels with an AC-coupled input for best performance. Only one of the AGC, DRC, or DRE features can be enabled at a time. The device can be configured in DRC mode by setting DRC_EN (P0_R108_D1) to 1'b1. The DRC scheme can be independently enabled or disabled for each channel using the CH1_DREEN (P0_R60_D0) and CH2_DREEN (P0_R65_D0) register bits. For a DC-coupled input, the DRC scheme can be used with limited DRE_MAXGAIN depending on the DC differential input common-mode offset.

Only change the DRC configuration registers before powering up the device. Enabling the DRC for processing increases the power consumption of the device because of increased signal processing. Therefore, disable the DRC for low-power critical applications. Furthermore, the DRC is not supported for output sample rates greater than 192 kHz.

8.3.9 Automatic Gain Controller (AGC)

The device includes an automatic gain controller (AGC) for ADC recording. As shown in 图 8-63, the AGC can be used to maintain a nominally constant output level when recording speech. Instead of manually setting the channel gain in AGC mode, the circuitry automatically adjusts the channel gain when the input signal becomes overly loud or very weak, such as when a person speaking into a microphone moves closer to or farther from the microphone. The AGC algorithm has several programmable parameters, including target level, maximum gain allowed, attack and release (or decay) time constants, and noise thresholds that allow the algorithm to be fine-tuned for any particular application.



图 8-63. AGC Characteristics

The target level (AGC_LVL) represents the nominal approximate output level at which the AGC attempts to hold the ADC output signal level. The PCM6120-Q1 allows programming of different target levels, which can be programmed from - 6 dB to - 36 dB relative to a full-scale signal, and the AGC_LVL default value is set to - 34 dB. The target level is recommended to be set with enough margin to prevent clipping when loud sounds occur. 表 8-49 lists the AGC target level configuration settings.

表 8-49. AGC Target Level Programmable Settings

P0_R112_D[7:4] : AGC_LVL[3:0]	AGC TARGET LEVEL FOR OUTPUT
0000	The AGC target level is the - 6-dB output signal level
0001	The AGC target level is the - 8-dB output signal level
0010	The AGC target level is the - 10-dB output signal level
...	...
1110 (default)	The AGC target level is the - 34-dB output signal level
1111	The AGC target level is the - 36-dB output signal level

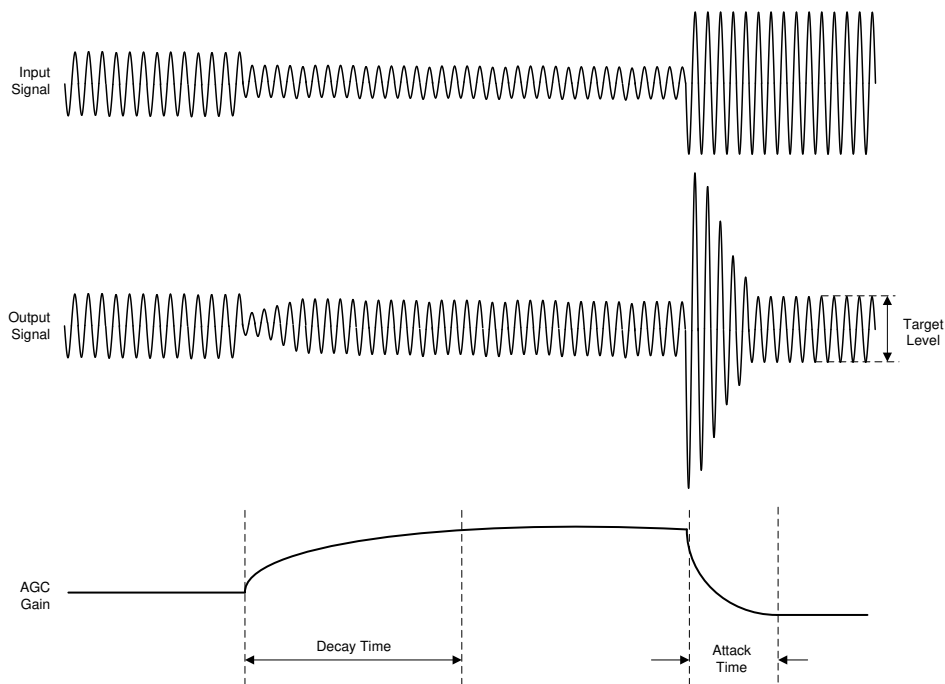
The maximum gain allowed (AGC_MAXGAIN) gives flexibility to the designer to restrict the maximum gain applied by the AGC. This feature limits the channel gain in situations where environmental noise is greater than the programmed noise threshold. The AGC_MAXGAIN can be programmed from 3 dB to 42 dB with steps of 3 dB and the default value is set to 24 dB. 表 8-50 lists the AGC_MAXGAIN configuration settings.

表 8-50. AGC Maximum Gain Programmable Settings

P0_R112_D[3:0] : AGC_MAXGAIN[3:0]	AGC MAXIMUM GAIN ALLOWED
0000	The AGC maximum gain allowed is 3 dB
0001	The AGC maximum gain allowed is 6 dB
0010	The AGC maximum gain allowed is 9 dB
...	...
0111 (default)	The AGC maximum gain allowed is 24 dB
...	...
1110	The AGC maximum gain allowed is 39 dB
1111	The AGC maximum gain allowed is 42 dB

For further details on the AGC various configurable parameter and application use, see the [Using the Automatic Gain Controller \(AGC\) in TLV320ADCx120 Family application report](#).

8.3.10 Voice Activity Detection (VAD)

The PCM6120-Q1 supports voice activity detection (VAD) mode. In this mode, the PCM6120-Q1 continuously monitors one of the input channels for voice detection. The device consumes low quiescent current from the AVDD supply in this mode. This feature can be enabled by setting VAD_EN (P0_R117_D0) to 1'b1. On detecting voice activity, the PCM6120-Q1 can alert the host through an interrupt or auto wake up and start recording based on the I²C programmed configuration. This alert can be configured through the VAD_MODE (P1_R30_D[7:6]) register bits.

This feature is supported on both the analog and digital microphone interfaces. For lowest power VAD, the digital microphone interface is recommended. The input channel for the VAD can be selected by setting the VAD_CH_SEL (P1_R30_D[5:4]) register bits to an appropriate value. See the [Using the Voice Activity Detector \(VAD\) in the TLV320ADC5120 and TLV320ADC6120 application report](#) for further details.

8.3.11 Digital PDM Microphone Record Channel

In addition to supporting analog microphones, the device also interfaces to digital pulse-density-modulation (PDM) microphones and uses high-order and high-performance decimation filters to generate pulse code modulation (PCM) output data that can be transmitted on the audio serial interface to the host. The device supports up to four digital microphone recording channels. If the second channel analog microphone is not used in the system, then the analog input pins (IN2P and IN2M) can be repurposed as the GPIO1 and GPO1 pins, respectively, and can be configured for the PDMCLK and PDMCLK clocks for digital PDM microphone recording. GPIO1 or GPIO2 (multiplexed with MICBIAS) can be used as PDMCLK to enable four-channel PDM microphone recording. If two-channel analog input recording is needed, MICBIAS (configured as GPIO2) and GPIO1 can be used as PDMCLK and PDMCLK, respectively, to enable two-channel DMIC recording along with two-channel AIN recording. The device can support a total of four channels at the input (analog and digital).

The device internally generates PDMCLK with a programmable frequency of either 6.144 MHz, 3.072 MHz, 1.536 MHz, or 768 kHz (for output data sample rates in multiples or submultiples of 48 kHz) or 5.6448 MHz, 2.8224 MHz, 1.4112 MHz, or 705.6 kHz (for output data sample rates in multiples or submultiples of 44.1 kHz) using the PDMCLK_DIV[1:0] (P0_R31_D[1:0]) register bits. PDMCLK can be routed on the GPO1 and GPIO1 pins. This clock can be connected to the external digital microphone device. [图 8-64](#) shows a connection diagram of the digital PDM microphones.



图 8-64. Digital PDM Microphones Connection Diagram for the PCM6120-Q1

The single-bit output of the external digital microphone device can be connected to the GPIO pin. This single data line can be shared by two digital microphones to place their data on the opposite edge of PDMCLK. Internally, the device latches the steady value of the data on either the rising or falling edge of PDMCLK based on the configuration register bits set in P0_R32_D[7:4]. [图 8-65](#) shows the digital PDM microphone interface timing diagram.

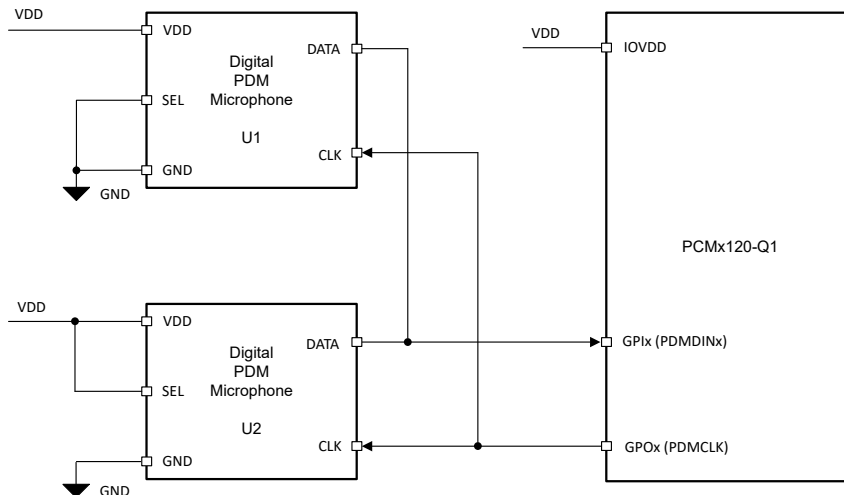

图 8-65. Digital PDM Microphone Protocol Timing Diagram

When the digital microphone is used for recording, the analog blocks of the respective ADC channel are powered down and bypassed for power efficiency. Use the CH1_INSRC[1:0] (P0_R60_D[6:5]) and CH2_INSRC[1:0] (P0_R65_D[6:5]) register bits to select the analog microphone or digital microphone for channel 1 to channel 2. Channel 3 and channel 4 support only the digital microphone interface.

8.3.12 Interrupts, Status, and Digital I/O Pin Multiplexing

Certain events in the device may require host processor intervention and can be used to trigger interrupts to the host processor. One such event is an audio serial interface (ASI) bus error. The device powers down the record channels if any faults are detected with the ASI bus error clocks, such as:

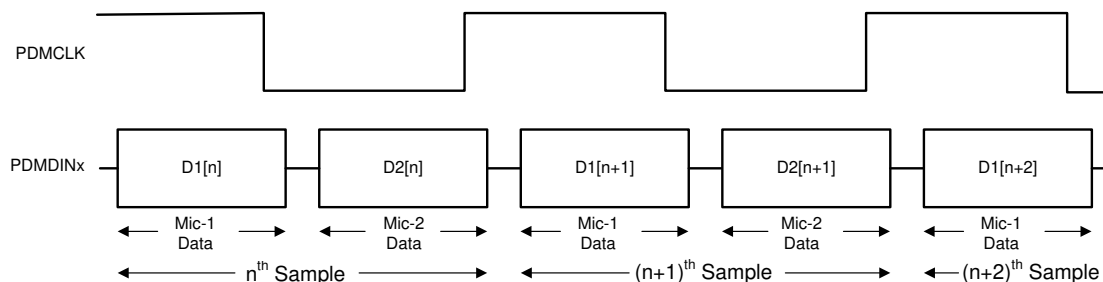
- Invalid FSYNC frequency
- Invalid SBCLK to FSYNC ratio
- Long pauses of the SBCLK or FSYNC clocks

When an ASI bus clock error is detected, the device shuts down the record channel as quickly as possible. After all ASI bus clock errors are resolved, the device volume ramps back to its previous state to recover the record channel. During an ASI bus clock error, the internal interrupt request (IRQ) interrupt signal asserts low if the clock error interrupt mask register bit INT_MASK0[7] (P0_R51_D7) is set low. The clock fault is also available for readback in the latched fault status register bit INT_LTCH0 (P0_R54), which is a read-only register. Reading the latched fault status register, INT_LTCH0, clears all latched fault status. The device can be additionally configured to route the internal IRQ interrupt signal on the GPIO1 or GPOx pins and also can be configured as open-drain outputs so that these pins can be wire-ANDed to the open-drain interrupt outputs of other devices.

The IRQ interrupt signal can either be configured as active low or active high polarity by setting the INT_POL (P0_R50_D7) register bit. This signal can also be configured as a single pulse or a series of pulses by programming the INT_EVENT[1:0] (P0_R50_D[6:5]) register bits. If the interrupts are configured as a series of pulses, the events trigger the start of pulses that stop when the latched fault status register is read to determine the cause of the interrupt.

The device also supports read-only live-status registers to determine if the channels are powered up or down and if the device is in sleep mode or not. These status registers are located in the DEV_STS0 (P0_R118) and DEV_STS1 (P0_R119) register bits.

The device has a multifunctional GPIO1 pin that can be configured for a desired specific function. Additionally, if the channel is not used for analog input recording, then the analog input pins for that channel (INxP and INxM) can be repurposed as multifunction pins (GPIx and GPOx) by configuring the CHx_INSRC[1:0] register bits located in the CHx_CFG0 register. The maximum number of GPO pins supported by the device is four and the maximum number of GPI pins are four. [表 8-51](#) lists all possible allocations of these multifunctional pins for the various features.

表 8-51. Multifunction Pin Assignments

ROW	PIN FUNCTION ⁽³⁾	GPIO1	GPO1	GPI1	GPI2
—	—	GPIO1_CFG	GPO1_CFG	GPI1_CFG	GPI2_CFG
—	—	P0_R33[7:4]	P0_R34[7:4]	P0_R43[6:4]	P0_R43[2:0]
A	Pin disabled	S ⁽¹⁾	S (default)	S (default)	S (default)
B	General-purpose output (GPO)	S	S	NS ⁽²⁾	NS
C	Interrupt output (IRQ)	S (default)	S	NS	NS
D	Power down for all ADC channels	S	NS	S	S
E	PDM clock output (PDMCLK)	S	S	NS	NS
F	MiCBias on/off input (BIASEN)	S	NS	NS	NS
G	General-purpose input (GPI)	S	NS	S	S
H	Master clock input (MCLK)	S	NS	S	S
I	ASI daisy-chain input (SDIN)	S	NS	S	S
J	PDM data input 1 (PDMDIN1)	S	NS	S	S
K	PDM data input 2 (PDMDIN2)	S	NS	S	S

- (1) S means the feature mentioned in this row is *supported* for the respective GPIO1, GPOx, or GPIx pin mentioned in this column.
(2) NS means the feature mentioned in this row is *not supported* for the respective GPIO1, GPOx, or GPIx pin mentioned in this column.
(3) Only the GPIO1 pin is with reference to the IOVDD supply, the other GPOx and GPIx pins are with reference to the AVDD supply and their primary pin functions are for the PDMCLK or PDMDIN function.

Each GPOx or GPIOx pin can be independently set for the desired drive configurations setting using the GPOx_DRV[3:0] or GPIO1_DRV[3:0] register bits. 表 8-52 lists the drive configuration settings.

表 8-52. GPIO or GPOx Pins Drive Configuration Settings

P0_R33_D[3:0] : GPIO1_DRV[3:0]	GPIO OUTPUT DRIVE CONFIGURATION SETTINGS FOR GPIO1
000	The GPIO1 pin is set to high impedance (floated)
001	The GPIO1 pin is set to be driven active low or active high
010 (default)	The GPIO1 pin is set to be driven active low or weak high (on-chip pullup)
011	The GPIO1 pin is set to be driven active low or Hi-Z (floated)
100	The GPIO1 pin is set to be driven weak low (on-chip pulldown) or active high
101	The GPIO1 pin is set to be driven Hi-Z (floated) or active high
110 and 111	Reserved (do not use these settings)

Similarly, the GPO1 pin can be configured using the GPO1_DRV(P0_R34) register bits.

When configured as a general-purpose output (GPO), the GPIO1 or GPOx pin values can be driven by writing the GPIO_VAL or GPOx_VAL (P0_R41) registers. The GPIO_MON (P0_R42) register can be used to readback the status of the GPIO1 pin when configured as a general-purpose input (GPI). Similarly, the GPI_MON (P0_R47) register can be used to readback the status of the GPIx pins when configured as a general-purpose input (GPI).

8.4 Device Functional Modes

8.4.1 Sleep Mode or Software Shutdown

In sleep mode or software shutdown mode, the device consumes very low quiescent current from the AVDD supply and, at the same time, allows the I²C communication to wake the device for active operation.

The device enters sleep mode when the host device sets the SLEEP_ENZ (P0_R2_D0) bit to 1'b0. If the SLEEP_ENZ bit is asserted low when the device is in active mode, the device ramps down the volume on the record data, powers down the analog and digital blocks, and enters sleep mode. However, the device still continues to retain the last programmed value of the device configuration registers and programmable coefficients.

In sleep mode, do not perform any I²C transactions, except for exiting sleep mode in order to enter active mode. After entering sleep mode, wait at least 10 ms before starting I²C transactions to exit sleep mode.

When exiting sleep mode, the host device must configure the PCM6120-Q1 to use either an external 1.8-V AREG supply (default setting) or an on-chip-regulator-generated AREG supply. To configure the AREG supply, write to AREG_SELECT, bit D7 in the same P0_R2 register.

8.4.2 Active Mode

If the host device exits sleep mode by setting the SLEEP_ENZ bit to 1'b1, the device enters active mode. In active mode, I²C transactions can be done to configure and power-up the device for active operation. After entering active mode, wait at least 1 ms before starting any I²C transactions in order to allow the device to complete the internal wake-up sequence.

Read and write operations to the programmable coefficient registers in page 2, page 3, and page 4, and to the channel configuration registers (CHx_CFG[1:4]), DRE_CFG0, and AGC_CFG0 in page 0 must be done 10 ms after exiting sleep mode.

After configuring all other registers for the target application and system settings, configure the input and output channel enable registers, IN_CH_EN (P0_R115) and ASI_OUT_CH_EN (P0_R116), respectively. Lastly, configure the device power-up register, PWR_CFG (P0_R117). All programmable coefficient values must be written before powering up the respective channel.

In active mode, the power-up and power-down status of various blocks is monitored by reading the read-only device status bits located in the DEV_STS0 (P0_R117) and DEV_STS1 (P0_R118) registers.

8.4.3 Software Reset

A software reset can be done any time by asserting the SW_RESET (P0_R1_D0) register bit, which is a self-clearing bit. This software reset immediately shuts down the device, and restores all device configuration registers and programmable coefficients to their default values.

8.5 Programming

The device contains configuration registers and programmable coefficients that can be set to the desired values for a specific system and application use. These registers are called *device control registers* and are each eight bits in width, mapped using a page scheme.

Each page contains 128 configuration registers. All device configuration registers are stored in page 0, which is the default page setting at power up and after a software reset. All programmable coefficient registers are located in page 2, page 3, and page 4. The current page of the device can be switched to a new desired page by using the PAGE[7:0] bits located in register 0 of every page.

8.5.1 Control Serial Interfaces

The device control registers can be accessed using I²C communication to the device. The device operates with a fixed I²C address and can be configured using this address.

8.5.1.1 I²C Control Interface

The device supports the I²C control protocol as a target device, and is capable of operating in standard mode, fast mode, and fast mode plus. The I²C control protocol requires a 7-bit target address. The 7-bit target address is fixed at 1001110 and cannot be changed. If the I2C_BRDCAST_EN (P0_R2_D2) bit is set to 1'b1, then the I²C target address is fixed to 1001100 in order to allow simultaneous I²C broadcast communication to multiple devices in the system, including the PCMx140-Q1, PCMD3140-Q1, and PCMD3180-Q1 devices. 表 8-53 lists the possible device addresses resulting from this configuration.

表 8-53. I²C Target Address Settings

I2C_BRDCAST_EN (P0_R2_D2)	I ² C TARGET ADDRESS
0 (default)	1001 110
1	1001 100

8.5.1.1.1 General I²C Operation

The I²C bus employs two signals, SDA (data) and SCL (clock), to communicate between integrated circuits in a system using serial data transmission. The address and data 8-bit bytes are transferred MSB first. In addition, each byte transferred on the bus is acknowledged by the receiving device with an acknowledge bit. Each transfer operation begins with the controller device driving a start condition on the bus and ends with the controller device driving a stop condition on the bus. The bus uses transitions on the data pin (SDA) while the clock is at logic high to indicate start and stop conditions. A high-to-low transition on SDA indicates a start, and a low-to-high transition indicates a stop. Normal data-bit transitions must occur within the low time of the clock period.

The controller device drives a start condition followed by the 7-bit target address and the read/write (R/W) bit to open communication with another device and then waits for an acknowledgment condition. The target device holds SDA low during the acknowledge clock period to indicate acknowledgment. When this occurs, the controller device transmits the next byte of the sequence. Each target device is addressed by a unique 7-bit target address plus the R/W bit (1 byte). All compatible devices share the same signals via a bidirectional bus using a wired-AND connection.

There is no limit on the number of bytes that can be transmitted between start and stop conditions. When the last word transfers, the controller device generates a stop condition to release the bus. 图 8-66 shows a generic data transfer sequence.



图 8-66. Typical I²C Sequence

In the system, use external pullup resistors for the SDA and SCL signals to set the logic high level for the bus. The SDA and SCL voltages must not exceed the device supply voltage, IOVDD.

8.5.1.1.1.1 I²C Single-Byte and Multiple-Byte Transfers

The device I²C interface supports both single-byte and multiple-byte read/write operations for all registers. During multiple-byte read operations, the device responds with data, a byte at a time, starting at the register assigned, as long as the controller device continues to respond with acknowledgements.

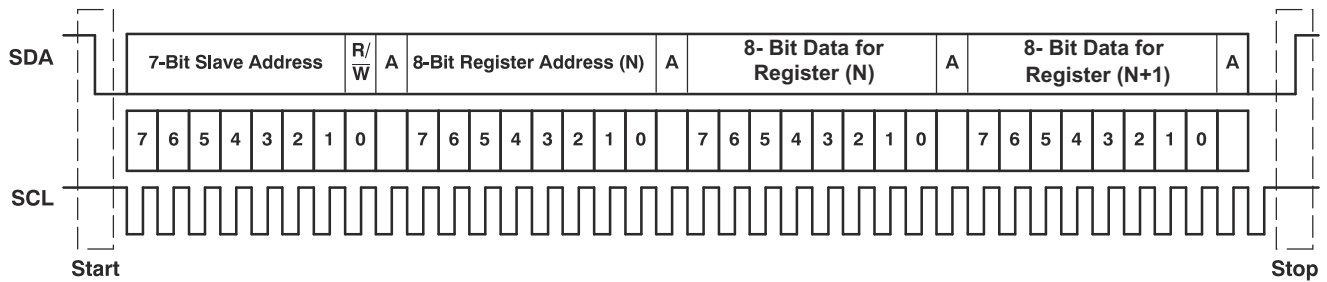
The device supports sequential I²C addressing. For write transactions, if a register is issued followed by data for that register and all the remaining registers that follow, a sequential I²C write transaction takes place. For I²C sequential write transactions, the register issued then serves as the starting point, and the amount of data subsequently transmitted, before a stop or start is transmitted, determines how many registers are written.

8.5.1.1.1.1.1 I²C Single-Byte Write

As shown in 图 8-67, a single-byte data write transfer begins with the controller device transmitting a start condition followed by the I²C device address and the read/write bit. The read/write bit determines the direction of the data transfer. For a write-data transfer, the read/write bit must be set to 0. After receiving the correct I²C target address and the read/write bit, the device responds with an acknowledge bit (ACK). Next, the controller device transmits the register byte corresponding to the device internal register address being accessed. After receiving the register byte, the device again responds with an acknowledge bit (ACK). Then, the controller transmits the byte of data to be written to the specified register. When finished, the target device responds with an acknowledge bit (ACK). Finally, the controller device transmits a stop condition to complete the single-byte data write transfer.



图 8-67. I²C Single-Byte Write Transfer

8.5.1.1.1.2 I²C Multiple-Byte Write

As shown in [Figure 8-68](#), a multiple-byte data write transfer is identical to a single-byte data write transfer except that multiple data bytes are transmitted by the controller device to the target device. After receiving each data byte, the device responds with an acknowledge bit (ACK). Finally, the controller device transmits a stop condition after the last data-byte write transfer.

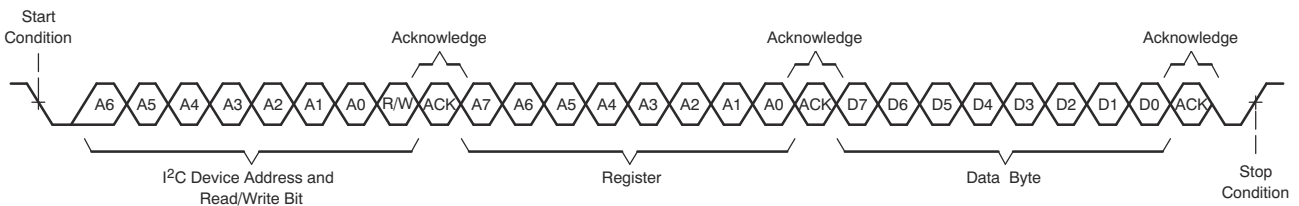
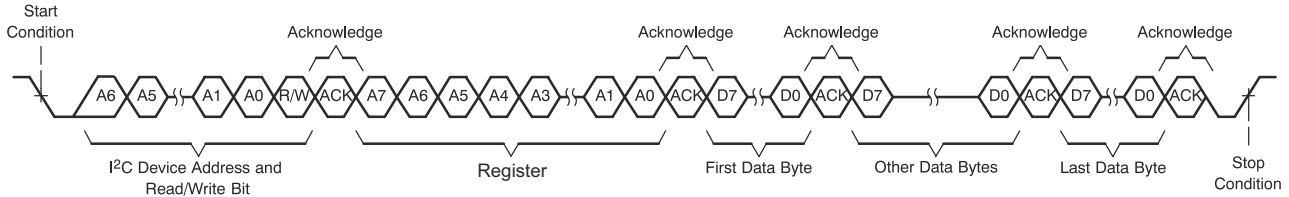

Figure 8-68. I²C Multiple-Byte Write Transfer

8.5.1.1.1.3 I²C Single-Byte Read

As shown in [Figure 8-69](#), a single-byte data read transfer begins with the controller device transmitting a start condition followed by the I²C target address and the read/write bit. For the data read transfer, both a write followed by a read are done. Initially, a write is done to transfer the address byte of the internal register address to be read. As a result, the read/write bit is set to 0.

After receiving the target address and the read/write bit, the device responds with an acknowledge bit (ACK). The controller device then sends the internal register address byte, after which the device issues an acknowledge bit (ACK). The controller device transmits another start condition followed by the target address and the read/write bit again. This time, the read/write bit is set to 1, indicating a read transfer. Next, the device transmits the data byte from the register address being read. After receiving the data byte, the controller device transmits a not-acknowledge (NACK) followed by a stop condition to complete the single-byte data read transfer.

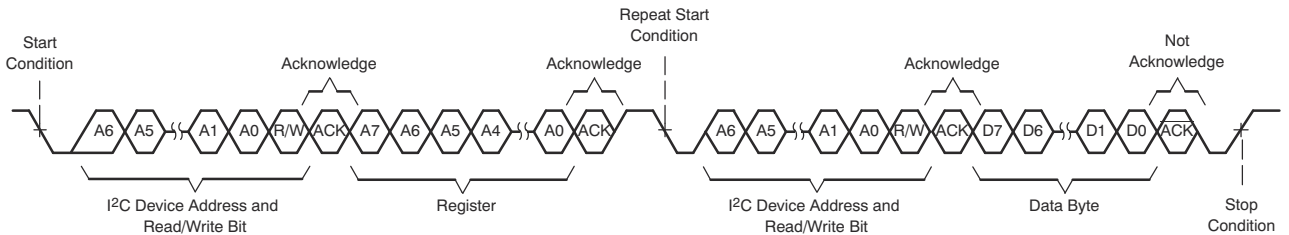

Figure 8-69. I²C Single-Byte Read Transfer

8.5.1.1.1.4 I²C Multiple-Byte Read

As shown in [Figure 8-70](#), a multiple-byte data read transfer is identical to a single-byte data read transfer except that multiple data bytes are transmitted by the device to the controller device. With the exception of the last data byte, the controller device responds with an acknowledge bit after receiving each data byte. After receiving the last data byte, the controller device transmits a not-acknowledge (NACK) followed by a stop condition to complete the data read transfer.

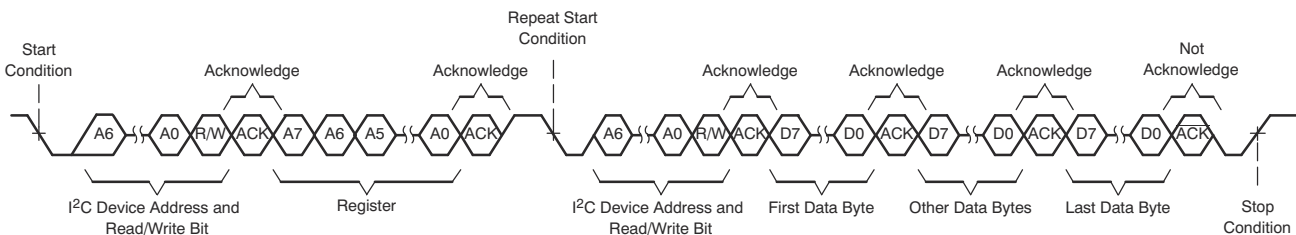

Figure 8-70. I²C Multiple-Byte Read Transfer

8.6 Register Maps

This section describes the control registers for the device in detail. All registers are eight bits in width and are allocated to device configuration and programmable coefficients settings. These registers are mapped internally using a page scheme that can be controlled using I²C communication to the device. Each page contains 128 bytes of registers. All device configuration registers are stored in page 0, which is the default page setting at power up (and after a software reset). All programmable coefficient registers are located in page 2, page 3, and page 4. The device current page can be switch to a new desired page by using the PAGE[7:0] bits located in register 0 of every page.

Do not read from or write to reserved pages or reserved registers. Write only default values for the reserved bits in the valid registers.

The procedure for register access across pages is:

- Select page N (write data *N* to register 0 regardless of the current page number)
- Read or write data from or to valid registers in page N
- Select the new page M (write data *M* to register 0 regardless of the current page number)
- Read or write data from or to valid registers in page M
- Repeat as needed

8.6.1 Device Configuration Registers

This section describes the device configuration registers for page 0 and page 1.

8.6.1.1 PCM6120-Q1 Access Codes

节 8.6.1.1 lists the access codes used for the PCM6120-Q1 registers.

表 8-54. PCMx120-Q1 Access Type Codes

ACCESS TYPE	CODE	DESCRIPTION
Read Type		
R	R	Read
R-W	R/W	Read or write
Write Type		
W	W	Write
Reset or Default Value		
-n		Value after reset or the default value

8.6.2 Page 0 Registers

表 8-55 lists the memory-mapped registers for the Page 0 registers. All register offset addresses not listed in 表 8-55 should be considered as reserved locations and the register contents should not be modified.

表 8-55. PAGE 0 Registers

Address	Acronym	Register Name	Reset Value	Section
0x0	PAGE_CFG	Device page register	0x00	节 8.6.2.1
0x1	SW_RESET	Software reset register	0x00	节 8.6.2.2
0x2	SLEEP_CFG	Sleep mode register	0x00	节 8.6.2.3
0x5	SHDN_CFG	Shutdown configuration register	0x05	节 8.6.2.4
0x7	ASI_CFG0	ASI configuration register 0	0x30	节 8.6.2.5
0x8	ASI_CFG1	ASI configuration register 1	0x00	节 8.6.2.6
0x9	ASI_CFG2	ASI configuration register 2	0x00	节 8.6.2.7
0xA	ASI_MIX_CFG	ASI input mixing configuration register	0x00	节 8.6.2.8
0xB	ASI_CH1	Channel 1 ASI slot configuration register	0x00	节 8.6.2.9
0xC	ASI_CH2	Channel 2 ASI slot configuration register	0x01	节 8.6.2.10
0xD	ASI_CH3	Channel 3 ASI slot configuration register	0x02	节 8.6.2.11
0xE	ASI_CH4	Channel 4 ASI slot configuration register	0x03	节 8.6.2.12
0x13	MST_CFG0	ASI master mode configuration register 0	0x02	节 8.6.2.13
0x14	MST_CFG1	ASI master mode configuration register 1	0x48	节 8.6.2.14
0x15	ASI_STS	ASI bus clock monitor status register	0xFF	节 8.6.2.15
0x16	CLK_SRC	Clock source configuration register 0	0x10	节 8.6.2.16
0x1F	PDMCLK_CFG	PDM clock generation configuration register	0x40	节 8.6.2.17
0x20	PDMIN_CFG	PDM DINx sampling edge register	0x00	节 8.6.2.18
0x21	GPIO_CFG0	GPIO configuration register 0	0x22	节 8.6.2.19
0x22	GPO_CFG0	GPO configuration register 0	0x00	节 8.6.2.20
0x29	GPO_VAL	GPIO, GPO output value register	0x00	节 8.6.2.21
0x2A	GPIO_MON	GPIO monitor value register	0x00	节 8.6.2.22
0x2B	GPI_CFG0	GPI configuration register 0	0x00	节 8.6.2.23
0x2F	GPI_MON	GPI monitor value register	0x00	节 8.6.2.24
0x32	INT_CFG	Interrupt configuration register	0x00	节 8.6.2.25
0x33	INT_MASK0	Interrupt mask register 0	0xFF	节 8.6.2.26
0x36	INT_LTCH0	Latched interrupt readback register 0	0x00	节 8.6.2.27
0x3A	CM_TOL_CFG	ADC common mode configuration register	0x00	节 8.6.2.28
0x3B	BIAS_CFG	Bias and ADC configuration register	0x00	节 8.6.2.29
0x3C	CH1_CFG0	Channel 1 configuration register 0	0x00	节 8.6.2.30
0x3D	CH1_CFG1	Channel 1 configuration register 1	0x00	节 8.6.2.31
0x3E	CH1_CFG2	Channel 1 configuration register 2	0xC9	节 8.6.2.32
0x3F	CH1_CFG3	Channel 1 configuration register 3	0x80	节 8.6.2.33
0x40	CH1_CFG4	Channel 1 configuration register 4	0x00	节 8.6.2.34
0x41	CH2_CFG0	Channel 2 configuration register 0	0x00	节 8.6.2.35
0x42	CH2_CFG1	Channel 2 configuration register 1	0x00	节 8.6.2.36
0x43	CH2_CFG2	Channel 2 configuration register 2	0xC9	节 8.6.2.37
0x44	CH2_CFG3	Channel 2 configuration register 3	0x80	节 8.6.2.38
0x45	CH2_CFG4	Channel 2 configuration register 4	0x00	节 8.6.2.39

表 8-55. PAGE 0 Registers (continued)

Address	Acronym	Register Name	Reset Value	Section
0x48	CH3_CFG2	Channel 3 configuration register 2	0xC9	节 8.6.2.40
0x49	CH3_CFG3	Channel 3 configuration register 3	0x80	节 8.6.2.41
0x4A	CH3_CFG4	Channel 3 configuration register 4	0x00	节 8.6.2.42
0x4D	CH4_CFG2	Channel 4 configuration register 2	0xC9	节 8.6.2.43
0x4E	CH4_CFG3	Channel 4 configuration register 3	0x80	节 8.6.2.44
0x4F	CH4_CFG4	Channel 4 configuration register 4	0x00	节 8.6.2.45
0x6B	DSP_CFG0	DSP configuration register 0	0x01	节 8.6.2.46
0x6C	DSP_CFG1	DSP configuration register 1	0x40	节 8.6.2.47
0x6D	DRE_CFG0	DRE configuration register 0	0x7B	节 8.6.2.48
0x70	AGC_CFG0	AGC configuration register 0	0xE7	节 8.6.2.49
0x71	GAIN_CFG	Gain change Configuration	0x00	节 8.6.2.50
0x73	IN_CH_EN	Input channel enable configuration register	0xC0	节 8.6.2.51
0x74	ASI_OUT_CH_EN	ASI output channel enable configuration register	0x00	节 8.6.2.52
0x75	PWR_CFG	Power up configuration register	0x00	节 8.6.2.53
0x76	DEV_STS0	Device status value register 0	0x00	节 8.6.2.54
0x77	DEV_STS1	Device status value register 1	0x80	节 8.6.2.55
0x7E	I2C_CKSUM	I ² C checksum register	0x00	节 8.6.2.56

8.6.2.1 PAGE_CFG Register (Address = 0x0) [Reset = 0x00]

PAGE_CFG is shown in [表 8-56](#).

Return to the [表 8-55](#).

The device memory map is divided into pages. This register sets the page.

表 8-56. PAGE_CFG Register Field Descriptions

Bit	Field	Type	Reset	Description
7-0	PAGE[7:0]	R/W	00000000b	These bits set the device page. 0d = Page 0 1d = Page 1 2d to 254d = Page 2 to page 254 respectively 255d = Page 255

8.6.2.2 SW_RESET Register (Address = 0x1) [Reset = 0x00]

SW_RESET is shown in [表 8-57](#).

Return to the [表 8-55](#).

This register is the software reset register. Asserting a software reset places all register values in their default power-on-reset (POR) state.

表 8-57. SW_RESET Register Field Descriptions

Bit	Field	Type	Reset	Description
7-1	RESERVED	R	0000000b	Reserved bits; Write only reset value
0	SW_RESET	R/W	0b	Software reset. This bit is self clearing. 0d = Do not reset 1d = Reset all registers to their reset values

8.6.2.3 SLEEP_CFG Register (Address = 0x2) [Reset = 0x00]

SLEEP_CFG is shown in [表 8-58](#).

Return to the [表 8-55](#).

This register configures the regulator, VREF quick charge, I²C broadcast and sleep mode.

表 8-58. SLEEP_CFG Register Field Descriptions

Bit	Field	Type	Reset	Description
7	AREG_SELECT	R/W	0b	The analog supply selection from either the internal regulator supply or the external AREG supply. 0d = External 1.8-V AREG supply (use this setting when AVDD is 1.8 V and short AREG with AVDD) 1d = Internally generated 1.8-V AREG supply using an on-chip regulator (use this setting when AVDD is 3.3 V)
6-5	RESERVED	R/W	00b	Reserved bits; Write only reset values
4-3	VREF_QCHG[1:0]	R/W	00b	The duration of the quick-charge for the VREF external capacitor is set using an internal series impedance of 200 Ω . 0d = VREF quick-charge duration of 3.5 ms (typical) 1d = VREF quick-charge duration of 10 ms (typical) 2d = VREF quick-charge duration of 50 ms (typical) 3d = VREF quick-charge duration of 100 ms (typical)
2	I2C_BRDCAST_EN	R/W	0b	I ² C broadcast addressing setting. 0d = I ² C broadcast mode disabled 1d = I ² C broadcast mode enabled; the I ² C target address is fixed at 1001 100
1	RESERVED	R	0b	Reserved bit; Write only reset value
0	SLEEP_ENZ	R/W	0b	Sleep mode setting. 0d = Device is in sleep mode 1d = Device is not in sleep mode

8.6.2.4 SHDN_CFG Register (Address = 0x5) [Reset = 0x05]

SHDN_CFG is shown in [表 8-59](#).

Return to the [表 8-55](#).

This register configures the device shutdown

表 8-59. SHDN_CFG Register Field Descriptions

Bit	Field	Type	Reset	Description
7-6	RESERVED	R	00b	Reserved bits; Write only reset value
5-4	INCAP_QCHG[1:0]	R/W	00b	The duration of the quick-charge for the external AC-coupling capacitor is set using an internal series impedance of 800 Ω . 0d = INxP, INxM quick-charge duration of 2.5 ms (typical) 1d = INxP, INxM quick-charge duration of 12.5 ms (typical) 2d = INxP, INxM quick-charge duration of 25 ms (typical) 3d = INxP, INxM quick-charge duration of 50 ms (typical)
3-2	RESERVED	R/W	01b	Reserved bits; Write only reset values
1-0	RESERVED	R/W	01b	Reserved bits; Write only reset values

8.6.2.5 ASI_CFG0 Register (Address = 0x7) [Reset = 0x30]

ASI_CFG0 is shown in [表 8-60](#).

Return to the [表 8-55](#).

This register is the ASI configuration register 0.

表 8-60. ASI_CFG0 Register Field Descriptions

Bit	Field	Type	Reset	Description
7-6	ASI_FORMAT[1:0]	R/W	00b	ASI protocol format. 0d = TDM mode 1d = I ² S mode 2d = LJ (left-justified) mode 3d = Reserved; Don't use
5-4	ASI_WLEN[1:0]	R/W	11b	ASI word or slot length. 0d = 16 bits (Recommended this setting to be used with 10-k Ω or 20-k Ω input impedance configuration) 1d = 20 bits 2d = 24 bits 3d = 32 bits
3	FSYNC_POL	R/W	0b	ASI FSYNC polarity. 0d = Default polarity as per standard protocol 1d = Inverted polarity with respect to standard protocol
2	BCLK_POL	R/W	0b	ASI BCLK polarity. 0d = Default polarity as per standard protocol 1d = Inverted polarity with respect to standard protocol
1	TX_EDGE	R/W	0b	ASI data output (on the primary and secondary data pin) transmit edge. 0d = Default edge as per the protocol configuration setting in bit 2 (BCLK_POL) 1d = Inverted following edge (half cycle delay) with respect to the default edge setting
0	TX_FILL	R/W	0b	ASI data output (on the primary and secondary data pin) for any unused cycles 0d = Always transmit 0 for unused cycles 1d = Always use Hi-Z for unused cycles

8.6.2.6 ASI_CFG1 Register (Address = 0x8) [Reset = 0x00]

ASI_CFG1 is shown in [表 8-61](#).

Return to the [表 8-55](#).

This register is the ASI configuration register 1.

表 8-61. ASI_CFG1 Register Field Descriptions

Bit	Field	Type	Reset	Description
7	TX_LSB	R/W	0b	ASI data output (on the primary and secondary data pin) for LSB transmissions. 0d = Transmit the LSB for a full cycle 1d = Transmit the LSB for the first half cycle and Hi-Z for the second half cycle
6-5	TX_KEEPER[1:0]	R/W	00b	ASI data output (on the primary and secondary data pin) bus keeper. 0d = Bus keeper is always disabled 1d = Bus keeper is always enabled 2d = Bus keeper is enabled during LSB transmissions only for one cycle 3d = Bus keeper is enabled during LSB transmissions only for one and half cycles

表 8-61. ASI_CFG1 Register Field Descriptions (continued)

Bit	Field	Type	Reset	Description
4-0	TX_OFFSET[4:0]	R/W	00000b	ASI data MSB slot 0 offset (on the primary and secondary data pin). 0d = ASI data MSB location has no offset and is as per standard protocol 1d = ASI data MSB location (TDM mode is slot 0 or I ² S, LJ mode is the left and right slot 0) offset of one BCLK cycle with respect to standard protocol 2d = ASI data MSB location (TDM mode is slot 0 or I ² S, LJ mode is the left and right slot 0) offset of two BCLK cycles with respect to standard protocol 3d to 30d = ASI data MSB location (TDM mode is slot 0 or I ² S, LJ mode is the left and right slot 0) offset assigned as per configuration 31d = ASI data MSB location (TDM mode is slot 0 or I ² S, LJ mode is the left and right slot 0) offset of 31 BCLK cycles with respect to standard protocol

8.6.2.7 ASI_CFG2 Register (Address = 0x9) [Reset = 0x00]

ASI_CFG2 is shown in 表 8-62.

Return to the 表 8-55.

This register is the ASI configuration register 2.

表 8-62. ASI_CFG2 Register Field Descriptions

Bit	Field	Type	Reset	Description
7	ASI_DAISSY	R/W	0b	ASI daisy chain connection. 0d = All devices are connected in the common ASI bus 1d = All devices are daisy-chained for the ASI bus. This is supported only if ASI input mixing is disabled, refer register 10 for details on ASI input mixing feature.
6	RESERVED	R	0b	Reserved bit; Write only reset value
5	ASI_ERR	R/W	0b	ASI bus error detection. 0d = Enable bus error detection 1d = Disable bus error detection
4	ASI_ERR_RCOV	R/W	0b	ASI bus error auto resume. 0d = Enable auto resume after bus error recovery 1d = Disable auto resume after bus error recovery and remain powered down until the host configures the device
3	RESERVED	R/W	0b	Reserved bit; Write only reset value
2-0	RESERVED	R	000b	Reserved bits; Write only reset value

8.6.2.8 ASI_MIX_CFG Register (Address = 0xA) [Reset = 0x00]

ASI_MIX_CFG is shown in 表 8-63.

Return to the 表 8-55.

This register is the ASI input mixing configuration register.

表 8-63. ASI_MIX_CFG Register Field Descriptions

Bit	Field	Type	Reset	Description
7-6	ASI_MIX_SEL[1:0]	R/W	00b	ASI input (from GPIx or GPIO) mixing selection with channel data. 0d = No mixing 1d = Channel 1 and channel 2 output data mixed with ASI input data on channel 1 (slot 0) 2d = Channel 1 and channel 2 output data mixed with ASI input data on channel 2 (slot 1) 3d = Mixed both channel data with ASI input data independently. Mixed asi_in_ch_1 with channel 1 output data and similarly mix asi_in_ch_2 with channel 2 output data
5-4	ASI_GAIN_SEL[1:0]	R/W	00b	ASI input data gain selection before mixing to channel data. 0d = No gain 1d = Gain asi input data by -6dB 2d = Gain asi input data by -12dB 3d = Gain asi input data by -18dB
3	ASI_IN_INVERSE	R/W	0b	Invert ASI input data before mixing to channel data. 0d = No inversion done for ASI input data 1d = ASI input data inverted before mixing with channel data
2	RESERVED	R	0b	Reserved bit; Write only reset value
1	RESERVED	R	0b	Reserved bit; Write only reset value
0	RESERVED	R	0b	Reserved bit; Write only reset value

8.6.2.9 ASI_CH1 Register (Address = 0xB) [Reset = 0x00]

ASI_CH1 is shown in [表 8-64](#).

Return to the [表 8-55](#).

This register is the ASI slot configuration register for channel 1.

表 8-64. ASI_CH1 Register Field Descriptions

Bit	Field	Type	Reset	Description
7-6	RESERVED	R	00b	Reserved bits; Write only reset value
5-0	CH1_SLOT[5:0]	R/W	000000b	Channel 1 slot assignment. 0d = TDM is slot 0 or I ² S, LJ is left slot 0 1d = TDM is slot 1 or I ² S, LJ is left slot 1 2d to 30d = Slot assigned as per configuration 31d = TDM is slot 31 or I ² S, LJ is left slot 31 32d = TDM is slot 32 or I ² S, LJ is right slot 0 33d = TDM is slot 33 or I ² S, LJ is right slot 1 34d to 62d = Slot assigned as per configuration 63d = TDM is slot 63 or I ² S, LJ is right slot 31

8.6.2.10 ASI_CH2 Register (Address = 0xC) [Reset = 0x01]

ASI_CH2 is shown in [表 8-65](#).

Return to the [表 8-55](#).

This register is the ASI slot configuration register for channel 2.

表 8-65. ASI_CH2 Register Field Descriptions

Bit	Field	Type	Reset	Description
7-6	RESERVED	R	00b	Reserved bits; Write only reset value

表 8-65. ASI_CH2 Register Field Descriptions (continued)

Bit	Field	Type	Reset	Description
5-0	CH2_SLOT[5:0]	R/W	000001b	Channel 2 slot assignment. 0d = TDM is slot 0 or I ² S, LJ is left slot 0 1d = TDM is slot 1 or I ² S, LJ is left slot 1 2d to 30d = Slot assigned as per configuration 31d = TDM is slot 31 or I ² S, LJ is left slot 31 32d = TDM is slot 32 or I ² S, LJ is right slot 0 33d = TDM is slot 33 or I ² S, LJ is right slot 1 34d to 62d = Slot assigned as per configuration 63d = TDM is slot 63 or I ² S, LJ is right slot 31

8.6.2.11 ASI_CH3 Register (Address = 0xD) [Reset = 0x02]

ASI_CH3 is shown in 表 8-66.

Return to the 表 8-55.

This register is the ASI slot configuration register for channel 3.

表 8-66. ASI_CH3 Register Field Descriptions

Bit	Field	Type	Reset	Description
7-6	RESERVED	R	00b	Reserved bits; Write only reset value
5-0	CH3_SLOT[5:0]	R/W	000010b	Channel 3 slot assignment. 0d = TDM is slot 0 or I ² S, LJ is left slot 0 1d = TDM is slot 1 or I ² S, LJ is left slot 1 2d to 30d = Slot assigned as per configuration 31d = TDM is slot 31 or I ² S, LJ is left slot 31 32d = TDM is slot 32 or I ² S, LJ is right slot 0 33d = TDM is slot 33 or I ² S, LJ is right slot 1 34d to 62d = Slot assigned as per configuration 63d = TDM is slot 63 or I ² S, LJ is right slot 31

8.6.2.12 ASI_CH4 Register (Address = 0xE) [Reset = 0x03]

ASI_CH4 is shown in 表 8-67.

Return to the 表 8-55.

This register is the ASI slot configuration register for channel 4.

表 8-67. ASI_CH4 Register Field Descriptions

Bit	Field	Type	Reset	Description
7-6	RESERVED	R	00b	Reserved bits; Write only reset value
5-0	CH4_SLOT[5:0]	R/W	000011b	Channel 4 slot assignment. 0d = TDM is slot 0 or I ² S, LJ is left slot 0 1d = TDM is slot 1 or I ² S, LJ is left slot 1 2d to 30d = Slot assigned as per configuration 31d = TDM is slot 31 or I ² S, LJ is left slot 31 32d = TDM is slot 32 or I ² S, LJ is right slot 0 33d = TDM is slot 33 or I ² S, LJ is right slot 1 34d to 62d = Slot assigned as per configuration 63d = TDM is slot 63 or I ² S, LJ is right slot 31

8.6.2.13 MST_CFG0 Register (Address = 0x13) [Reset = 0x02]

MST_CFG0 is shown in 表 8-68.

Return to the 表 8-55.

This register is the ASI master mode configuration register 0.

表 8-68. MST_CFG0 Register Field Descriptions

Bit	Field	Type	Reset	Description
7	MST_SLV_CFG	R/W	0b	ASI master or slave configuration register setting. 0d = Device is in slave mode (both BCLK and FSYNC are inputs to the device) 1d = Device is in master mode (both BCLK and FSYNC are generated from the device)
6	AUTO_CLK_CFG	R/W	0b	Automatic clock configuration setting. 0d = Auto clock configuration is enabled (all internal clock divider and PLL configurations are auto derived) 1d = Auto clock configuration is disabled (custom mode and device GUI must be used for the device configuration settings)
5	AUTO_MODE_PLL_DIS	R/W	0b	Automatic mode PLL setting. 0d = PLL is enabled in auto clock configuration 1d = PLL is disabled in auto clock configuration
4	BCLK_FSYNC_GATE	R/W	0b	BCLK and FSYNC clock gate (valid when the device is in master mode). 0d = Do not gate BCLK and FSYNC 1d = Force gate BCLK and FSYNC when being transmitted from the device in master mode
3	FS_MODE	R/W	0b	Sample rate setting (valid when the device is in master mode). 0d = f_s is a multiple (or submultiple) of 48 kHz 1d = f_s is a multiple (or submultiple) of 44.1 kHz
2-0	MCLK_FREQ_SEL[2:0]	R/W	010b	These bits select the MCLK (GPIO or GPIx) frequency for the PLL source clock input (valid when the device is in master mode and MCLK_FREQ_SEL_MODE = 0). 0d = 12 MHz 1d = 12.288 MHz 2d = 13 MHz 3d = 16 MHz 4d = 19.2 MHz 5d = 19.68 MHz 6d = 24 MHz 7d = 24.576 MHz

8.6.2.14 MST_CFG1 Register (Address = 0x14) [Reset = 0x48]

MST_CFG1 is shown in [表 8-69](#).

Return to the [表 8-55](#).

This register is the ASI master mode configuration register 1.

表 8-69. MST_CFG1 Register Field Descriptions

Bit	Field	Type	Reset	Description
7-4	FS_RATE[3:0]	R/W	0100b	Programmed sample rate of the ASI bus (not used when the device is configured in slave mode auto clock configuration). 0d = 7.35 kHz or 8 kHz 1d = 14.7 kHz or 16 kHz 2d = 22.05 kHz or 24 kHz 3d = 29.4 kHz or 32 kHz 4d = 44.1 kHz or 48 kHz 5d = 88.2 kHz or 96 kHz 6d = 176.4 kHz or 192 kHz 7d = 352.8 kHz or 384 kHz 8d = 705.6 kHz or 768 kHz 9d to 15d = Reserved; Don't use

表 8-69. MST_CFG1 Register Field Descriptions (continued)

Bit	Field	Type	Reset	Description
3-0	FS_BCLK_RATIO[3:0]	R/W	1000b	Programmed BCLK to FSYNC frequency ratio of the ASI bus (not used when the device is configured in slave mode auto clock configuration). 0d = Ratio of 16 1d = Ratio of 24 2d = Ratio of 32 3d = Ratio of 48 4d = Ratio of 64 5d = Ratio of 96 6d = Ratio of 128 7d = Ratio of 192 8d = Ratio of 256 9d = Ratio of 384 10d = Ratio of 512 11d = Ratio of 1024 12d = Ratio of 2048 13d to 15d = Reserved; Don't use

8.6.2.15 ASI_STS Register (Address = 0x15) [Reset = 0xFF]

ASI_STS is shown in 表 8-70.

Return to the 表 8-55.

This register is the ASI bus clock monitor status register

表 8-70. ASI_STS Register Field Descriptions

Bit	Field	Type	Reset	Description
7-4	FS_RATE_STS[3:0]	R	1111b	Detected sample rate of the ASI bus. 0d = 7.35 kHz or 8 kHz 1d = 14.7 kHz or 16 kHz 2d = 22.05 kHz or 24 kHz 3d = 29.4 kHz or 32 kHz 4d = 44.1 kHz or 48 kHz 5d = 88.2 kHz or 96 kHz 6d = 176.4 kHz or 192 kHz 7d = 352.8 kHz or 384 kHz 8d = 705.6 kHz or 768 kHz 9d to 14d = Reserved status 15d = Invalid sample rate
3-0	FS_RATIO_STS[3:0]	R	1111b	Detected BCLK to FSYNC frequency ratio of the ASI bus. 0d = Ratio of 16 1d = Ratio of 24 2d = Ratio of 32 3d = Ratio of 48 4d = Ratio of 64 5d = Ratio of 96 6d = Ratio of 128 7d = Ratio of 192 8d = Ratio of 256 9d = Ratio of 384 10d = Ratio of 512 11d = Ratio of 1024 12d = Ratio of 2048 13d to 14d = Reserved status 15d = Invalid ratio

8.6.2.16 CLK_SRC Register (Address = 0x16) [Reset = 0x10]

CLK_SRC is shown in 表 8-71.

Return to the [表 8-55](#).

This register is the clock source configuration register.

表 8-71. CLK_SRC Register Field Descriptions

Bit	Field	Type	Reset	Description
7	DIS_PLL_SLV_CLK_SRC	R/W	0b	Audio root clock source setting when the device is configured with the PLL disabled in the auto clock configuration for slave mode (AUTO_MODE_PLL_DIS = 1). 0d = BCLK is used as the audio root clock source 1d = MCLK (GPIO or GPIx) is used as the audio root clock source (the MCLK to FSYNC ratio is as per MCLK_RATIO_SEL setting)
6	MCLK_FREQ_SEL_MODE	R/W	0b	Master mode MCLK (GPIO or GPIx) frequency selection mode (valid when the device is in auto clock configuration). 0d = MCLK frequency is based on the MCLK_FREQ_SEL (P0_R19) configuration 1d = MCLK frequency is specified as a multiple of FSYNC in the MCLK_RATIO_SEL (P0_R22) configuration
5-3	MCLK_RATIO_SEL[2:0]	R/W	010b	These bits select the MCLK (GPIO or GPIx) to FSYNC ratio for master mode or when MCLK is used as the audio root clock source in slave mode. 0d = Ratio of 64 1d = Ratio of 256 2d = Ratio of 384 3d = Ratio of 512 4d = Ratio of 768 5d = Ratio of 1024 6d = Ratio of 1536 7d = Ratio of 2304
2	RESERVED	R/W	0b	Reserved bit; Write only reset value
1	INV_BCLK_FOR_FSYNC	R/W	0b	Invert BCLK polarity only for FSYNC generation in master mode configuration. 0d = Do not invert BCLK polarity for FSYNC generation 1d = Invert BCLK polarity for FSYNC generation
0	RESERVED	R/W	0b	Reserved bit; Write only reset value

8.6.2.17 PDMCLK_CFG Register (Address = 0x1F) [Reset = 0x40]

PDMCLK_CFG is shown in [表 8-72](#).

Return to the [表 8-55](#).

This register is the PDM clock generation configuration register.

表 8-72. PDMCLK_CFG Register Field Descriptions

Bit	Field	Type	Reset	Description
7	RESERVED	R/W	0b	Reserved bit; Write only reset value
6-2	RESERVED	R/W	10000b	Reserved bits; Write only reset values
1-0	PDMCLK_DIV[1:0]	R/W	00b	PDMCLK divider value. 0d = PDMCLK is 2.8224 MHz or 3.072 MHz 1d = PDMCLK is 1.4112 MHz or 1.536 MHz 2d = PDMCLK is 705.6 kHz or 768 kHz 3d = PDMCLK is 5.6448 MHz or 6.144 MHz (applicable only for PDM channel 1 and 2)

8.6.2.18 PDMIN_CFG Register (Address = 0x20) [Reset = 0x00]

PDMIN_CFG is shown in [表 8-73](#).

Return to the [表 8-55](#).

This register is the PDM DINx sampling edge configuration register.

表 8-73. PDMIN_CFG Register Field Descriptions

Bit	Field	Type	Reset	Description
7	PDMDIN1_EDGE	R/W	0b	PDMCLK latching edge used for channel 1 and channel 2 data. 0d = Channel 1 data are latched on the negative edge, channel 2 data are latched on the positive edge 1d = Channel 1 data are latched on the positive edge, channel 2 data are latched on the negative edge
6	RESERVED	R/W	0b	Reserved bit; Write only reset value
5-0	RESERVED	R	000000b	Reserved bits; Write only reset value

8.6.2.19 GPIO_CFG0 Register (Address = 0x21) [Reset = 0x22]

GPIO_CFG0 is shown in [表 8-74](#).

Return to the [表 8-55](#).

This register is the GPIO configuration register 0.

表 8-74. GPIO_CFG0 Register Field Descriptions

Bit	Field	Type	Reset	Description
7-4	GPIO1_CFG[3:0]	R/W	0010b	GPIO1 configuration. 0d = GPIO1 is disabled 1d = GPIO1 is configured as a general-purpose output (GPO) 2d = GPIO1 is configured as a device interrupt output (IRQ) 3d = Reserved; Don't use 4d = GPIO1 is configured as a PDM clock output (PDMCLK) 5d = Reserved; Don't use 6d = Reserved; Don't use 7d = PD all ADC channels 8d = GPIO1 is configured as an input to control when MICBIAS turns on or off (MICBIAS_EN) 9d = GPIO1 is configured as a general-purpose input (GPI) 10d = GPIO1 is configured as a master clock input (MCLK) 11d = GPIO1 is configured as an ASI input for daisy-chain or ASI input for mixing (SDIN) 12d = GPIO1 is configured as a PDM data input for channel 1 and channel 2 (PDMDIN1) 13d = GPIO1 is configured as a PDM data input for channel 3 and channel 4 (PDMDIN2) 14d to 15d = Reserved; Don't use
3	RESERVED	R	0b	Reserved bit; Write only reset value
2-0	GPIO1_DRV[2:0]	R/W	010b	GPIO1 output drive configuration. 0d = Hi-Z output 1d = Drive active low and active high 2d = Drive active low and weak high 3d = Drive active low and Hi-Z 4d = Drive weak low and active high 5d = Drive Hi-Z and active high 6d to 7d = Reserved; Don't use

8.6.2.20 GPO_CFG0 Register (Address = 0x22) [Reset = 0x00]

GPO_CFG0 is shown in [表 8-75](#).

Return to the [表 8-55](#).

This register is the GPO configuration register 0.

表 8-75. GPO_CFG0 Register Field Descriptions

Bit	Field	Type	Reset	Description
7-4	GPO1_CFG[3:0]	R/W	0000b	IN2M_GPO1 (GPO1) configuration. 0d = GPO1 is disabled 1d = GPO1 is configured as a general-purpose output (GPO) 2d = GPO1 is configured as a device interrupt output (IRQ) 3d = Reserved; Don't use 4d = GPO1 is configured as a PDM clock output (PDMCLK) 5d to 15d = Reserved; Don't use
3	RESERVED	R	0b	Reserved bit; Write only reset value
2-0	GPO1_DRV[2:0]	R/W	000b	IN2M_GPO1 (GPO1) output drive configuration. 0d = Hi-Z output 1d = Drive active low and active high 2d = Reserved; Don't use 3d = Drive active low and Hi-Z 4d = Reserved; Don't use 5d = Drive Hi-Z and active high 6d to 7d = Reserved; Don't use

8.6.2.21 GPO_VAL Register (Address = 0x29) [Reset = 0x00]

GPO_VAL is shown in [表 8-76](#).

Return to the [表 8-55](#).

This register is the GPIO and GPO output value register.

表 8-76. GPO_VAL Register Field Descriptions

Bit	Field	Type	Reset	Description
7	GPIO1_VAL	R/W	0b	GPIO1 output value when configured as a GPO. 0d = Drive the output with a value of 0 1d = Drive the output with a value of 1
6	GPO1_VAL	R/W	0b	GPO1 output value when configured as a GPO. 0d = Drive the output with a value of 0 1d = Drive the output with a value of 1
5-0	RESERVED	R	000000b	Reserved bits; Write only reset value

8.6.2.22 GPIO_MON Register (Address = 0x2A) [Reset = 0x00]

GPIO_MON is shown in [表 8-77](#).

Return to the [表 8-55](#).

This register is the GPIO monitor value register.

表 8-77. GPIO_MON Register Field Descriptions

Bit	Field	Type	Reset	Description
7	GPIO1_MON	R	0b	GPIO1 monitor value when configured as a GPI. 0d = Input monitor value 0 1d = Input monitor value 1
6-0	RESERVED	R	0000000b	Reserved bits; Write only reset value

8.6.2.23 GPI_CFG0 Register (Address = 0x2B) [Reset = 0x00]

GPI_CFG0 is shown in [表 8-78](#).

Return to the [表 8-55](#).

This register is the GPI configuration register 0.

表 8-78. GPI_CFG0 Register Field Descriptions

Bit	Field	Type	Reset	Description
7	RESERVED	R	0b	Reserved bit; Write only reset value
6-4	GPI1_CFG[2:0]	R/W	000b	IN2P_GPI1 (GPI1) configuration. 0d = GPI1 is disabled 1d = GPI1 is configured as a general-purpose input (GPI) 2d = GPI1 is configured as a master clock input (MCLK) 3d = GPI1 is configured as an ASI input for daisy-chain or ASI input for mixing (SDIN) 4d = GPI1 is configured as a PDM data input for channel 1 and channel 2 (PDM DIN1) 5d = GPI1 is configured as a PDM data input for channel 3 and channel 4 (PDM DIN2) 6d = Reserved; Don't use 7d = PD all ADC channels
3	RESERVED	R	0b	Reserved bit; Write only reset value
2-0	GPI2_CFG[2:0]	R/W	000b	MICBIAS as GPI2 configuration. 0d = GPI2 is disabled 1d = GPI2 is configured as a general-purpose input (GPI) 2d = GPI2 is configured as a master clock input (MCLK) 3d = GPI2 is configured as an ASI input for daisy-chain or ASI input for mixing (SDIN) 4d = GPI2 is configured as a PDM data input for channel 1 and channel 2 (PDM DIN1) 5d = GPI2 is configured as a PDM data input for channel 3 and channel 4 (PDM DIN2) 6d = Reserved; Don't use 7d = PD all ADC channels

8.6.2.24 GPI_MON Register (Address = 0x2F) [Reset = 0x00]

GPI_MON is shown in [表 8-79](#).

Return to the [表 8-55](#).

This register is the GPI monitor value register.

表 8-79. GPI_MON Register Field Descriptions

Bit	Field	Type	Reset	Description
7	GPI1_MON	R	0b	GPI1 monitor value when configured as a GPI. 0d = Input monitor value 0 1d = Input monitor value 1
6	GPI2_MON	R	0b	GPI2 monitor value when MICBIAS is configured as a GPI. 0d = Input monitor value 0 1d = Input monitor value 1
5-0	RESERVED	R	000000b	Reserved bits; Write only reset value

8.6.2.25 INT_CFG Register (Address = 0x32) [Reset = 0x00]

INT_CFG is shown in [表 8-80](#).

Return to the [表 8-55](#).

This register is the interrupt configuration register.

表 8-80. INT_CFG Register Field Descriptions

Bit	Field	Type	Reset	Description
7	INT_POL	R/W	0b	Interrupt polarity. 0d = Active low (IRQZ) 1d = Active high (IRQ)

表 8-80. INT_CFG Register Field Descriptions (continued)

Bit	Field	Type	Reset	Description
6-5	INT_EVENT[1:0]	R/W	00b	Interrupt event configuration. 0d = INT asserts on any unmasked latched interrupts event Dont use 2d = INT asserts for 2 ms (typical) for every 4-ms (typical) duration on any unmasked latched interrupts event 3d = INT asserts for 2 ms (typical) one time on each pulse for any unmasked interrupts event
4-3	RESERVED	R	00b	Reserved bits; Write only reset value
2	LTCH_READ_CFG	R/W	0b	Interrupt latch registers readback configuration. 0d = All interrupts can be read through the LTCH registers 1d = Only unmasked interrupts can be read through the LTCH registers
1-0	RESERVED	R	00b	Reserved bits; Write only reset value

8.6.2.26 INT_MASK0 Register (Address = 0x33) [Reset = 0xFF]

INT_MASK0 is shown in [表 8-81](#).

Return to the [表 8-55](#).

This register is the interrupt masks register 0.

表 8-81. INT_MASK0 Register Field Descriptions

Bit	Field	Type	Reset	Description
7	INT_MASK0	R/W	1b	ASI clock error mask. 0d = Do not mask 1d = Mask
6	INT_MASK0	R/W	1b	PLL Lock interrupt mask. 0d = Do not mask 1d = Mask
5	INT_MASK0	R/W	1b	ASI input mixing saturation alert mask. 0d = Do not mask 1d = Mask
4	INT_MASK0	R/W	1b	VAD Power up detect interrupt mask. 0d = Do not mask 1d = Mask
3	INT_MASK0	R/W	1b	VAD Power down detect interrupt mask. 0d = Do not mask 1d = Mask
2	RESERVED	R/W	1b	Reserved bit; Write only reset value
1	RESERVED	R/W	1b	Reserved bit; Write only reset value
0	RESERVED	R/W	1b	Reserved bit; Write only reset value

8.6.2.27 INT_LTCH0 Register (Address = 0x36) [Reset = 0x00]

INT_LTCH0 is shown in [表 8-82](#).

Return to the [表 8-55](#).

This register is the latched Interrupt readback register 0.

表 8-82. INT_LTCH0 Register Field Descriptions

Bit	Field	Type	Reset	Description
7	INT_LTCH0	R	0b	Interrupt caused by an ASI bus clock error (self-clearing bit). 0d = No interrupt 1d = Interrupt

表 8-82. INT_LTCH0 Register Field Descriptions (continued)

Bit	Field	Type	Reset	Description
6	INT_LTCH0	R	0b	Interrupt caused by PLL LOCK (self-clearing bit). 0d = No interrupt 1d = Interrupt
5	INT_LTCH0	R	0b	Interrupt caused by ASI input mixing channel saturation alert (self clearing bit). 0d = No interrupt 1d = Interrupt
4	INT_LTCH0	R	0b	Interrupt caused by VAD power up detect (self clearing bit). 0d = No interrupt 1d = Interrupt
3	INT_LTCH0	R	0b	Interrupt caused by VAD power down detect (self clearing bit). 0d = No interrupt 1d = Interrupt
2	RESERVED	R	0b	Reserved bit; Write only reset value
1	RESERVED	R	0b	Reserved bit; Write only reset value
0	RESERVED	R	0b	Reserved bit; Write only reset value

8.6.2.28 CM_TOL_CFG Register (Address = 0x3A) [Reset = 0x00]

CM_TOL_CFG is shown in 表 8-83.

Return to the 表 8-55.

This register is the ADC common mode configuration register

表 8-83. CM_TOL_CFG Register Field Descriptions

Bit	Field	Type	Reset	Description
7-6	CH1_INP_CM_TOL_CFG[1:0]	R/W	00b	Channel 1 input common mode variance tolerance configuration. 0d = Common mode variance tolerance for AC coupled = 100 mVpp and DC coupled = 2.82 Vpp 1d = Common Mode Tolerance of: AC/DC Coupled Input=1V peak to peak 2d = Common Mode Tolerance of: AC/DC Coupled Input=0-AVDD(Supported only with Input Impedance of 10 kΩ/20 kΩ). For input impedance of 2.5 kΩ, input common mode tolerance= 0.4V to 2.6V. 3d = Reserved; Don't use
5-4	CH2_INP_CM_TOL_CFG[1:0]	R/W	00b	Channel 2 input common mode variance tolerance configuration. 0d = Common mode variance tolerance for AC coupled = 100 mVpp and DC coupled = 2.82 Vpp 1d = Common Mode Tolerance of: AC/DC Coupled Input=1V peak to peak 2d = Common Mode Tolerance of: AC/DC Coupled Input=0-AVDD(Supported only with Input Impedance of 10 kΩ/20 kΩ). For input impedance of 2.5 kΩ, input common mode tolerance= 0.4V to 2.6V. 3d = Reserved; Don't use
3-0	RESERVED	R	0000b	Reserved bits; Write only reset value

8.6.2.29 BIAS_CFG Register (Address = 0x3B) [Reset = 0x00]

BIAS_CFG is shown in 表 8-84.

Return to the 表 8-55.

This register is the bias and ADC configuration register

表 8-84. BIAS_CFG Register Field Descriptions

Bit	Field	Type	Reset	Description
7	RESERVED	R	0b	Reserved bit; Write only reset value
6-4	MBIAS_VAL[2:0]	R/W	000b	MICBIAS value. 0d = Microphone bias is set to VREF (2.750 V, 2.500 V, or 1.375 V) 1d = Microphone bias is set to VREF x 1.096 (3.014 V, 2.740 V, or 1.507 V) 2d = Microphone bias is set to VCM = IN1M, for ADC single-ended configuration 3d = Microphone bias is set to VCM = IN2M, for ADC single-ended configuration 4d = Microphone bias is set to VCM = average of IN1M and IN2M, for ADC single-ended configuration 5d = Microphone bias is set to VCM = internal crude common mode 6d = Microphone bias is set to AVDD 7d = MICBIAS configured as GPI2
3-2	RESERVED	R	00b	Reserved bits; Write only reset value
1-0	ADC_FSCALE[1:0]	R/W	00b	ADC full-scale setting (configure this setting based on the AVDD supply minimum voltage used). 0d = VREF is set to 2.75 V to support 2 V _{RMS} for the differential input or 1 V _{RMS} for the single-ended input 1d = VREF is set to 2.5 V to support 1.818 V _{RMS} for the differential input or 0.909 V _{RMS} for the single-ended input 2d = VREF is set to 1.375 V to support 1 V _{RMS} for the differential input or 0.5 V _{RMS} for the single-ended input 3d = Reserved; Don't use

8.6.2.30 CH1_CFG0 Register (Address = 0x3C) [Reset = 0x00]

CH1_CFG0 is shown in [表 8-85](#).

Return to the [表 8-55](#).

This register is configuration register 0 for channel 1.

表 8-85. CH1_CFG0 Register Field Descriptions

Bit	Field	Type	Reset	Description
7	CH1_INTYP	R/W	0b	Channel 1 input type. 0d = Microphone input 1d = Line input
6-5	CH1_INSRC[1:0]	R/W	00b	Channel 1 input configuration. 0d = Analog differential input 1d = Analog single-ended input 2d = Digital microphone PDM input (configure the GPO and GPI pins accordingly for PDMDIN1 and PDMCLK) 3d = Reserved; Don't use
4	CH1_DC	R/W	0b	Channel 1 input coupling (applicable for the analog input). 0d = AC-coupled input 1d = DC-coupled input
3-2	CH1_IMP[1:0]	R/W	00b	Channel 1 input impedance (applicable for the analog input). 0d = Typical 2.5-k Ω input impedance 1d = Typical 10-k Ω input impedance 2d = Typical 20-k Ω input impedance 3d = Reserved; Don't use
1	RESERVED	R	0b	Reserved bit; Write only reset value
0	CH1_DREEN	R/W	0b	Channel 1 dynamic range enhancer (DRE) and automatic gain controller (AGC) setting. 0d = DRE / AGC / DRC disabled 1d = DRE or AGC or DRC enabled based on the configuration of bit 3 in register 108 (P0_R108)

8.6.2.31 CH1_CFG1 Register (Address = 0x3D) [Reset = 0x00]

CH1_CFG1 is shown in [表 8-86](#).

Return to the [表 8-55](#).

This register is configuration register 1 for channel 1.

表 8-86. CH1_CFG1 Register Field Descriptions

Bit	Field	Type	Reset	Description
7-1	CH1_GAIN[6:0]	R/W	0000000b	Channel 1 gain. 0d = Channel gain is set to 0 dB 1d = Channel gain is set to 0.5 dB 2d = Channel gain is set to 1 dB 3d to 83d = Channel gain is set as per configuration 84d = Channel gain is set to 42 dB 85d to 127d = Reserved; Don't use
0	CH1_GAIN_SIGN_BIT	R/W	0b	Channel-1 gain sign configuration. 0d = Positive channel gain 1d = Negative channel gain (minimum channel gain supported till -11 dB; supported only for channel input impedance of 10-k Ω and 20-k Ω)

8.6.2.32 CH1_CFG2 Register (Address = 0x3E) [Reset = 0xC9]

CH1_CFG2 is shown in [表 8-87](#).

Return to the [表 8-55](#).

This register is configuration register 2 for channel 1.

表 8-87. CH1_CFG2 Register Field Descriptions

Bit	Field	Type	Reset	Description
7-0	CH1_DVOL[7:0]	R/W	11001001b	Channel 1 digital volume control. 0d = Digital volume is muted 1d = Digital volume control is set to -100 dB 2d = Digital volume control is set to -99.5 dB 3d to 200d = Digital volume control is set as per configuration 201d = Digital volume control is set to 0 dB 202d = Digital volume control is set to 0.5 dB 203d to 253d = Digital volume control is set as per configuration 254d = Digital volume control is set to 26.5 dB 255d = Digital volume control is set to 27 dB

8.6.2.33 CH1_CFG3 Register (Address = 0x3F) [Reset = 0x80]

CH1_CFG3 is shown in [表 8-88](#).

Return to the [表 8-55](#).

This register is configuration register 3 for channel 1.

表 8-88. CH1_CFG3 Register Field Descriptions

Bit	Field	Type	Reset	Description
7-4	CH1_GCAL[3:0]	R/W	1000b	Channel 1 gain calibration. 0d = Gain calibration is set to -0.8 dB 1d = Gain calibration is set to -0.7 dB 2d = Gain calibration is set to -0.6 dB 3d to 7d = Gain calibration is set as per configuration 8d = Gain calibration is set to 0 dB 9d = Gain calibration is set to 0.1 dB 10d to 13d = Gain calibration is set as per configuration 14d = Gain calibration is set to 0.6 dB 15d = Gain calibration is set to 0.7 dB
3-0	RESERVED	R	0000b	Reserved bits; Write only reset value

8.6.2.34 CH1_CFG4 Register (Address = 0x40) [Reset = 0x00]

CH1_CFG4 is shown in 表 8-89.

Return to the 表 8-55.

This register is configuration register 4 for channel 1.

表 8-89. CH1_CFG4 Register Field Descriptions

Bit	Field	Type	Reset	Description
7-0	CH1_PCAL[7:0]	R/W	00000000b	Channel 1 phase calibration with modulator clock resolution. 0d = No phase calibration 1d = Phase calibration delay is set to one cycle of the modulator clock 2d = Phase calibration delay is set to two cycles of the modulator clock 3d to 254d = Phase calibration delay as per configuration 255d = Phase calibration delay is set to 255 cycles of the modulator clock

8.6.2.35 CH2_CFG0 Register (Address = 0x41) [Reset = 0x00]

CH2_CFG0 is shown in 表 8-90.

Return to the 表 8-55.

This register is configuration register 0 for channel 2.

表 8-90. CH2_CFG0 Register Field Descriptions

Bit	Field	Type	Reset	Description
7	CH2_INTYP	R/W	0b	Channel 2 input type. 0d = Microphone input 1d = Line input
6-5	CH2_INSRC[1:0]	R/W	00b	Channel 2 input configuration. 0d = Analog differential input (the GPI1 and GPO1 pin functions must be disabled) 1d = Analog single-ended input (the GPI1 and GPO1 pin functions must be disabled) 2d = Digital microphone PDM input (configure the GPO and GPI pins accordingly for PDMDIN1 and PDMCLK) 3d = Reserved; Don't use
4	CH2_DC	R/W	0b	Channel 2 input coupling (applicable for the analog input). 0d = AC-coupled input 1d = DC-coupled input

表 8-90. CH2_CFG0 Register Field Descriptions (continued)

Bit	Field	Type	Reset	Description
3-2	CH2_IMP[1:0]	R/W	00b	Channel 2 input impedance (applicable for the analog input). 0d = Typical 2.5-k Ω input impedance 1d = Typical 10-k Ω input impedance 2d = Typical 20-k Ω input impedance 3d = Reserved; Don't use
1	RESERVED	R	0b	Reserved bit; Write only reset value
0	CH2_DREEN	R/W	0b	Channel 2 dynamic range enhancer (DRE) and automatic gain controller (AGC) setting. 0d = DRE / AGC / DRC disabled 1d = DRE or AGC or DRC enabled based on the configuration of bit 3 in register 108 (P0_R108)

8.6.2.36 CH2_CFG1 Register (Address = 0x42) [Reset = 0x00]

CH2_CFG1 is shown in [表 8-91](#).

Return to the [表 8-55](#).

This register is configuration register 1 for channel 2.

表 8-91. CH2_CFG1 Register Field Descriptions

Bit	Field	Type	Reset	Description
7-1	CH2_GAIN[6:0]	R/W	0000000b	Channel 2 gain. 0d = Channel gain is set to 0 dB 1d = Channel gain is set to 0.5 dB 2d = Channel gain is set to 1 dB 3d to 83d = Channel gain is set as per configuration 84d = Channel gain is set to 42 dB 85d to 127d = Reserved; Don't use
0	CH2_GAIN_SIGN_BIT	R/W	0b	Channel-2 gain sign configuration. 0d = Positive channel gain 1d = Negative channel gain (minimum channel gain supported till -11 dB; supported only for channel input impedance of 10-k Ω and 20-k Ω)

8.6.2.37 CH2_CFG2 Register (Address = 0x43) [Reset = 0xC9]

CH2_CFG2 is shown in [表 8-92](#).

Return to the [表 8-55](#).

This register is configuration register 2 for channel 2.

表 8-92. CH2_CFG2 Register Field Descriptions

Bit	Field	Type	Reset	Description
7-0	CH2_DVOL[7:0]	R/W	11001001b	Channel 2 digital volume control. 0d = Digital volume is muted 1d = Digital volume control is set to -100 dB 2d = Digital volume control is set to -99.5 dB 3d to 200d = Digital volume control is set as per configuration 201d = Digital volume control is set to 0 dB 202d = Digital volume control is set to 0.5 dB 203d to 253d = Digital volume control is set as per configuration 254d = Digital volume control is set to 26.5 dB 255d = Digital volume control is set to 27 dB

8.6.2.38 CH2_CFG3 Register (Address = 0x44) [Reset = 0x80]

CH2_CFG3 is shown in [表 8-93](#).

Return to the [表 8-55](#).

This register is configuration register 3 for channel 2.

表 8-93. CH2_CFG3 Register Field Descriptions

Bit	Field	Type	Reset	Description
7-4	CH2_GCAL[3:0]	R/W	1000b	Channel 2 gain calibration. 0d = Gain calibration is set to -0.8 dB 1d = Gain calibration is set to -0.7 dB 2d = Gain calibration is set to -0.6 dB 3d to 7d = Gain calibration is set as per configuration 8d = Gain calibration is set to 0 dB 9d = Gain calibration is set to 0.1 dB 10d to 13d = Gain calibration is set as per configuration 14d = Gain calibration is set to 0.6 dB 15d = Gain calibration is set to 0.7 dB
3-0	RESERVED	R	0000b	Reserved bits; Write only reset value

8.6.2.39 CH2_CFG4 Register (Address = 0x45) [Reset = 0x00]

CH2_CFG4 is shown in [表 8-94](#).

Return to the [表 8-55](#).

This register is configuration register 4 for channel 2.

表 8-94. CH2_CFG4 Register Field Descriptions

Bit	Field	Type	Reset	Description
7-0	CH2_PCAL[7:0]	R/W	00000000b	Channel 2 phase calibration with modulator clock resolution. 0d = No phase calibration 1d = Phase calibration delay is set to one cycle of the modulator clock 2d = Phase calibration delay is set to two cycles of the modulator clock 3d to 254d = Phase calibration delay as per configuration 255d = Phase calibration delay is set to 255 cycles of the modulator clock

8.6.2.40 CH3_CFG2 Register (Address = 0x48) [Reset = 0xC9]

CH3_CFG2 is shown in [表 8-95](#).

Return to the [表 8-55](#).

This register is configuration register 2 for channel 3.

表 8-95. CH3_CFG2 Register Field Descriptions

Bit	Field	Type	Reset	Description
7-0	CH3_DVOL[7:0]	R/W	11001001b	Channel 3 digital volume control. 0d = Digital volume is muted 1d = Digital volume control is set to -100 dB 2d = Digital volume control is set to -99.5 dB 3d to 200d = Digital volume control is set as per configuration 201d = Digital volume control is set to 0 dB 202d = Digital volume control is set to 0.5 dB 203d to 253d = Digital volume control is set as per configuration 254d = Digital volume control is set to 26.5 dB 255d = Digital volume control is set to 27 dB

8.6.2.41 CH3_CFG3 Register (Address = 0x49) [Reset = 0x80]

CH3_CFG3 is shown in [表 8-96](#).

Return to the [表 8-55](#).

This register is configuration register 3 for channel 3.

表 8-96. CH3_CFG3 Register Field Descriptions

Bit	Field	Type	Reset	Description
7-4	CH3_GCAL[3:0]	R/W	1000b	Channel 3 gain calibration. 0d = Gain calibration is set to -0.8 dB 1d = Gain calibration is set to -0.7 dB 2d = Gain calibration is set to -0.6 dB 3d to 7d = Gain calibration is set as per configuration 8d = Gain calibration is set to 0 dB 9d = Gain calibration is set to 0.1 dB 10d to 13d = Gain calibration is set as per configuration 14d = Gain calibration is set to 0.6 dB 15d = Gain calibration is set to 0.7 dB
3-0	RESERVED	R	0000b	Reserved bits; Write only reset value

8.6.2.42 CH3_CFG4 Register (Address = 0x4A) [Reset = 0x00]

CH3_CFG4 is shown in [表 8-97](#).

Return to the [表 8-55](#).

This register is configuration register 4 for channel 3.

表 8-97. CH3_CFG4 Register Field Descriptions

Bit	Field	Type	Reset	Description
7-0	CH3_PCAL[7:0]	R/W	00000000b	Channel 3 phase calibration with modulator clock resolution. 0d = No phase calibration 1d = Phase calibration delay is set to one cycle of the modulator clock 2d = Phase calibration delay is set to two cycles of the modulator clock 3d to 254d = Phase calibration delay as per configuration 255d = Phase calibration delay is set to 255 cycles of the modulator clock

8.6.2.43 CH4_CFG2 Register (Address = 0x4D) [Reset = 0xC9]

CH4_CFG2 is shown in [表 8-98](#).

Return to the [表 8-55](#).

This register is configuration register 2 for channel 4.

表 8-98. CH4_CFG2 Register Field Descriptions

Bit	Field	Type	Reset	Description
7-0	CH4_DVOL[7:0]	R/W	11001001b	Channel 4 digital volume control. 0d = Digital volume is muted 1d = Digital volume control is set to -100 dB 2d = Digital volume control is set to -99.5 dB 3d to 200d = Digital volume control is set as per configuration 201d = Digital volume control is set to 0 dB 202d = Digital volume control is set to 0.5 dB 203d to 253d = Digital volume control is set as per configuration 254d = Digital volume control is set to 26.5 dB 255d = Digital volume control is set to 27 dB

8.6.2.44 CH4_CFG3 Register (Address = 0x4E) [Reset = 0x80]

CH4_CFG3 is shown in [表 8-99](#).

Return to the [表 8-55](#).

This register is configuration register 3 for channel 4.

表 8-99. CH4_CFG3 Register Field Descriptions

Bit	Field	Type	Reset	Description
7-4	CH4_GCAL[3:0]	R/W	1000b	Channel 4 gain calibration. 0d = Gain calibration is set to -0.8 dB 1d = Gain calibration is set to -0.7 dB 2d = Gain calibration is set to -0.6 dB 3d to 7d = Gain calibration is set as per configuration 8d = Gain calibration is set to 0 dB 9d = Gain calibration is set to 0.1 dB 10d to 13d = Gain calibration is set as per configuration 14d = Gain calibration is set to 0.6 dB 15d = Gain calibration is set to 0.7 dB
3-0	RESERVED	R	0000b	Reserved bits; Write only reset value

8.6.2.45 CH4_CFG4 Register (Address = 0x4F) [Reset = 0x00]

CH4_CFG4 is shown in [表 8-100](#).

Return to the [表 8-55](#).

This register is configuration register 4 for channel 4.

表 8-100. CH4_CFG4 Register Field Descriptions

Bit	Field	Type	Reset	Description
7-0	CH4_PCAL[7:0]	R/W	00000000b	Channel 4 phase calibration with modulator clock resolution. 0d = No phase calibration 1d = Phase calibration delay is set to one cycle of the modulator clock 2d = Phase calibration delay is set to two cycles of the modulator clock 3d to 254d = Phase calibration delay as per configuration 255d = Phase calibration delay is set to 255 cycles of the modulator clock

8.6.2.46 DSP_CFG0 Register (Address = 0x6B) [Reset = 0x01]

DSP_CFG0 is shown in [表 8-101](#).

Return to the [表 8-55](#).

This register is the digital signal processor (DSP) configuration register 0.

表 8-101. DSP_CFG0 Register Field Descriptions

Bit	Field	Type	Reset	Description
7	DIS_DVOL_OTF_CHG	R/W	0b	Disable run-time changes to DVOL settings. 0d = Digital volume control changes supported while ADC is powered-on 1d = Digital volume control changes not supported while ADC is powered-on. This is useful for 384 kHz and higher sample rate if more than one channel processing is required.
6	ENH_DRE_AGC_DRC	R/W	0b	Enhanced DRE/AGC/DRC mode. 0d = Standard DRE/AGC/DRC algorithms 1d = Enhanced DRE/AGC/DRC algorithms

表 8-101. DSP_CFG0 Register Field Descriptions (continued)

Bit	Field	Type	Reset	Description
5-4	DECI_FILT[1:0]	R/W	00b	Decimation filter response. 0d = Linear phase 1d = Low latency 2d = Ultra-low latency 3d = Reserved; Don't use
3-2	CH_SUM[1:0]	R/W	00b	Channel summation mode for higher SNR 0d = Channel summation mode is disabled 1d = 2-channel summation mode is enabled to generate a (CH1 + CH2) / 2 output 2d = Reserved; Don't use 3d = Reserved; Don't use
1-0	HPF_SEL[1:0]	R/W	01b	High-pass filter (HPF) selection. 0d = Programmable first-order IIR filter for a custom HPF with default coefficient values in P4_R72 to P4_R83 set as the all-pass filter 1d = HPF with a cutoff of $0.00025 \times f_S$ (12 Hz at $f_S = 48$ kHz) is selected 2d = HPF with a cutoff of $0.002 \times f_S$ (96 Hz at $f_S = 48$ kHz) is selected 3d = HPF with a cutoff of $0.008 \times f_S$ (384 Hz at $f_S = 48$ kHz) is selected

8.6.2.47 DSP_CFG1 Register (Address = 0x6C) [Reset = 0x40]

DSP_CFG1 is shown in [表 8-102](#).

Return to the [表 8-55](#).

This register is the digital signal processor (DSP) configuration register 1.

表 8-102. DSP_CFG1 Register Field Descriptions

Bit	Field	Type	Reset	Description
7	DVOL_GANG	R/W	0b	DVOL control ganged across channels. 0d = Each channel has its own DVOL CTRL settings as programmed in the CHx_DVOL bits 1d = All active channels must use the channel 1 DVOL setting (CH1_DVOL) irrespective of whether channel 1 is turned on or not
6-5	BIQUAD_CFG[1:0]	R/W	10b	Number of biquads per channel configuration. 0d = No biquads per channel; biquads are all disabled 1d = 1 biquad per channel 2d = 2 biquads per channel 3d = 3 biquads per channel
4	DISABLE_SOFT_STEP	R/W	0b	Soft-stepping disable during DVOL change, mute, and unmute. 0d = Soft-stepping enabled 1d = Soft-stepping disabled
3	DRE_AGC_SEL	R/W	0b	DRE or AGC selection when is enabled for any channel if DRC_EN is 0 and CH_DRE_EN is enabled for a channel 0d = DRE is selected 1d = AGC is selected
2	RESERVED	R/W	0b	Reserved bit; Write only reset value
1	DRC_EN	R/W	0b	Dynamic range compression (DRC) same as DRE without gain compensation in digital 0d = DRC disabled. Device can be in DRE or AGC mode depending on DRE_AGC_SEL bit 1d = DRC enabled. Device cannot be in DRE or AGC mode.
0	EN_AVOID_CLIP	R/W	0b	Anti clipper when channel gain > 0 dB and either of DRE, DRC or AGC mode enabled. 0d = Channel gain is maintained as per user programmed value 1d = Signal level is compressed to avoid clipping when channel gain > 0 dB and signal level crosses programmed threshold setting set in page-4.

8.6.2.48 DRE_CFG0 Register (Address = 0x6D) [Reset = 0x7B]

DRE_CFG0 is shown in [表 8-103](#).

Return to the [表 8-55](#).

This register is the dynamic range enhancer (DRE) configuration register 0.

表 8-103. DRE_CFG0 Register Field Descriptions

Bit	Field	Type	Reset	Description
7-4	DRE_LVL[3:0]	R/W	0111b	DRE trigger signal level threshold. 0d = Input signal level threshold is -12 dB 1d = Input signal level threshold is -18 dB 2d = Input signal level threshold is -24 dB 3d to 6d = Input signal level threshold is as per configuration 7d = Input signal level threshold is -54 dB 8d = Input signal level threshold is -60 dB 9d = Input signal level threshold is -66 dB 10d to 15d = Reserved; Don't use
3-0	DRE_MAXGAIN[3:0]	R/W	1011b	DRE maximum gain allowed. 0d = Maximum gain allowed is 2 dB 1d = Maximum gain allowed is 4 dB 2d = Maximum gain allowed is 6 dB 3d to 10d = Maximum gain allowed is as per configuration 11d = Maximum gain allowed is 24 dB 12d = Maximum gain allowed is 26 dB 13d to 15d = Reserved; Don't use

8.6.2.49 AGC_CFG0 Register (Address = 0x70) [Reset = 0xE7]

AGC_CFG0 is shown in [表 8-104](#).

Return to the [表 8-55](#).

This register is the automatic gain controller (AGC) configuration register 0.

表 8-104. AGC_CFG0 Register Field Descriptions

Bit	Field	Type	Reset	Description
7-4	AGC_LVL[3:0]	R/W	1110b	AGC output signal target level. 0d = Output signal target level is -6 dB 1d = Output signal target level is -8 dB 2d = Output signal target level is -10 dB 3d to 13d = Output signal target level is as per configuration 14d = Output signal target level is -34 dB 15d = Output signal target level is -36 dB
3-0	AGC_MAXGAIN[3:0]	R/W	0111b	AGC maximum gain allowed. 0d = Maximum gain allowed is 3 dB 1d = Maximum gain allowed is 6 dB 2d = Maximum gain allowed is 9 dB 3d to 11d = Maximum gain allowed is as per configuration 12d = Maximum gain allowed is 39 dB 13d = Maximum gain allowed is 42 dB 14d to 15d = Reserved; Don't use

8.6.2.50 GAIN_CFG Register (Address = 0x71) [Reset = 0x00]

GAIN_CFG is shown in [表 8-105](#).

Return to the [表 8-55](#).

This register is the channel gain change configuration register.

表 8-105. GAIN_CFG Register Field Descriptions

Bit	Field	Type	Reset	Description
7-6	OTF_GAIN_CHANGE_CFG[1:0]	R/W	00b	On the fly channel gain change configuration 0d = On-the-fly gain change with some artifacts due to applying gain change immediately 1d = On-the-fly gain change enabled with reduced artifacts but without soft-stepping 2d = On-the-fly gain change enabled with soft-stepping of 0.5 dB per ~20 μ s, supported channel gain up to 30 dB for 10-k Ω input impedance mode and 24 dB for 20-k Ω input impedance mode 3d = On-the-fly gain change enabled with soft-stepping of 0.5 dB per ~40 μ s, supported channel gain up to 30 dB for 10-k Ω input impedance mode and 24 dB for 20-k Ω input impedance mode
5	RESERVED	R/W	0b	Reserved bit; Write only reset value
4-0	RESERVED	R	00000b	Reserved bits; Write only reset value

8.6.2.51 IN_CH_EN Register (Address = 0x73) [Reset = 0xC0]

IN_CH_EN is shown in 表 8-106.

Return to the 表 8-55.

This register is the input channel enable configuration register.

表 8-106. IN_CH_EN Register Field Descriptions

Bit	Field	Type	Reset	Description
7	IN_CH1_EN	R/W	1b	Input channel 1 enable setting. 0d = Channel 1 is disabled 1d = Channel 1 is enabled
6	IN_CH2_EN	R/W	1b	Input channel 2 enable setting. 0d = Channel 2 is disabled 1d = Channel 2 is enabled
5	IN_CH3_EN	R/W	0b	Input channel 3 (PDM only) enable setting. 0d = Channel 3 is disabled 1d = Channel 3 is enabled
4	IN_CH4_EN	R/W	0b	Input channel 4 (PDM only) enable setting. 0d = Channel 4 is disabled 1d = Channel 4 is enabled
3-0	RESERVED	R	0000b	Reserved bits; Write only reset value

8.6.2.52 ASI_OUT_CH_EN Register (Address = 0x74) [Reset = 0x00]

ASI_OUT_CH_EN is shown in 表 8-107.

Return to the 表 8-55.

This register is the ASI output channel enable configuration register.

表 8-107. ASI_OUT_CH_EN Register Field Descriptions

Bit	Field	Type	Reset	Description
7	ASI_OUT_CH1_EN	R/W	0b	ASI output channel 1 enable setting. 0d = Channel 1 output slot is in a tri-state condition 1d = Channel 1 output slot is enabled
6	ASI_OUT_CH2_EN	R/W	0b	ASI output channel 2 enable setting. 0d = Channel 2 output slot is in a tri-state condition 1d = Channel 2 output slot is enabled
5	ASI_OUT_CH3_EN	R/W	0b	ASI output channel 3 enable setting. 0d = Channel 3 output slot is in a tri-state condition 1d = Channel 3 output slot is enabled

表 8-107. ASI_OUT_CH_EN Register Field Descriptions (continued)

Bit	Field	Type	Reset	Description
4	ASI_OUT_CH4_EN	R/W	0b	ASI output channel 4 enable setting. 0d = Channel 4 output slot is in a tri-state condition 1d = Channel 4 output slot is enabled
3-0	RESERVED	R	0000b	Reserved bits; Write only reset value

8.6.2.53 PWR_CFG Register (Address = 0x75) [Reset = 0x00]

PWR_CFG is shown in [表 8-108](#).

Return to the [表 8-55](#).

This register is the power-up configuration register.

表 8-108. PWR_CFG Register Field Descriptions

Bit	Field	Type	Reset	Description
7	MICBIAS_PDZ	R/W	0b	Power control for MICBIAS. 0d = Power down MICBIAS 1d = Power up MICBIAS
6	ADC_PDZ	R/W	0b	Power control for ADC and PDM channels. 0d = Power down all ADC and PDM channels 1d = Power up all enabled ADC and PDM channels
5	PLL_PDZ	R/W	0b	Power control for the PLL. 0d = Power down the PLL 1d = Power up the PLL
4	DYN_CH_PUPD_EN	R/W	0b	Dynamic channel power-up, power-down enable. 0d = Channel power-up, power-down is not supported if any channel recording is on 1d = Channel can be powered up or down individually, even if channel recording is on
3-2	DYN_MAXCH_SEL[1:0]	R/W	00b	Dynamic mode maximum channel select configuration. 0d = Channel 1 and channel 2 are used with dynamic channel power-up, power-down feature enabled 1d = Channel 1 to channel 4 are used with dynamic channel power-up, power-down feature enabled 2d = Reserved; Don't use 3d = Reserved; Don't use
1	RESERVED	R/W	0b	Reserved bit; Write only reset value
0	VAD_EN	R/W	0b	Enable voice activity detection (VAD) algorithm. 0d = VAD is disabled 1d = VAD is enabled

8.6.2.54 DEV_STS0 Register (Address = 0x76) [Reset = 0x00]

DEV_STS0 is shown in [表 8-109](#).

Return to the [表 8-55](#).

This register is the device status value register 0.

表 8-109. DEV_STS0 Register Field Descriptions

Bit	Field	Type	Reset	Description
7	CH1_STATUS	R	0b	ADC or PDM channel 1 power status. 0d = ADC or PDM channel is powered down 1d = ADC or PDM channel is powered up
6	CH2_STATUS	R	0b	ADC or PDM channel 2 power status. 0d = ADC or PDM channel is powered down 1d = ADC or PDM channel is powered up

表 8-109. DEV_STS0 Register Field Descriptions (continued)

Bit	Field	Type	Reset	Description
5-0	RESERVED	R	000000b	Reserved bits; Write only reset value

8.6.2.55 DEV_STS1 Register (Address = 0x77) [Reset = 0x80]

DEV_STS1 is shown in [表 8-110](#).

Return to the [表 8-55](#).

This register is the device status value register 1.

表 8-110. DEV_STS1 Register Field Descriptions

Bit	Field	Type	Reset	Description
7-5	MODE_STS[2:0]	R	100b	Device mode status. 4d = Device is in sleep mode or software shutdown mode 6d = Device is in active mode with all ADC or PDM channels turned off 7d = Device is in active mode with at least one ADC or PDM channel turned on
4-0	RESERVED	R	00000b	Reserved bits; Write only reset value

8.6.2.56 I2C_CKSUM Register (Address = 0x7E) [Reset = 0x00]

I2C_CKSUM is shown in [表 8-111](#).

Return to the [表 8-55](#).

This register returns the I²C transactions checksum value.

表 8-111. I2C_CKSUM Register Field Descriptions

Bit	Field	Type	Reset	Description
7-0	I2C_CKSUM[7:0]	R/W	00000000b	These bits return the I ² C transactions checksum value. Writing to this register resets the checksum to the written value. This register is updated on writes to other registers on all pages.

8.6.3 Page 1 Registers

表 8-112 lists the memory-mapped registers for the Page 1 registers. All register offset addresses not listed in 表 8-112 should be considered as reserved locations and the register contents should not be modified.

表 8-112. PAGE 1 Registers

Address	Acronym	Register Name	Reset Value	Section
0x0	PAGE_CFG	Device page register	0x00	节 8.6.3.1
0x1E	VAD_CFG1	Voice activity detection configuration register 1	0x20	节 8.6.3.2
0x1F	VAD_CFG2	Voice activity detection configuration register 2	0x08	节 8.6.3.3

8.6.3.1 PAGE_CFG Register (Address = 0x0) [Reset = 0x0]

PAGE_CFG is shown in 图 8-71 and described in 表 8-113.

Return to the 表 8-112.

The device memory map is divided into pages. This register sets the page.

图 8-71. PAGE_CFG Register

7	6	5	4	3	2	1	0
PAGE[7:0]							
R/W-00000000b							

表 8-113. PAGE_CFG Register Field Descriptions

Bit	Field	Type	Reset	Description
7-0	PAGE[7:0]	R/W	00000000b	These bits set the device page. 0d = Page 0 1d = Page 1 2d to 254d = Page 2 to page 254 respectively 255d = Page 255

8.6.3.2 VAD_CFG1 Register (Address = 0x1E) [Reset = 0x20]

VAD_CFG1 is shown in 图 8-72 and described in 表 8-114.

Return to the 表 8-112.

This register is configuration register 1 for voice activity detection.

图 8-72. VAD_CFG1 Register

7	6	5	4	3	2	1	0
VAD_MODE[1:0]		VAD_CH_SEL[1:0]		VAD_CLK_CFG[1:0]		VAD_EXT_CLK_CFG[1:0]	
R/W-00b		R/W-10b		R/W-00b		R/W-00b	

表 8-114. VAD_CFG1 Register Field Descriptions

Bit	Field	Type	Reset	Description
7-6	VAD_MODE[1:0]	R/W	00b	Auto ADC power up / power down configuration selection. 0d = User initiated ADC power-up and ADC power-down 1d = VAD interrupt based ADC power up and ADC power down 2d = VAD interrupt based ADC power up but user initiated ADC power down 3d = User initiated ADC power-up but VAD interrupt based ADC power down

表 8-114. VAD_CFG1 Register Field Descriptions (continued)

Bit	Field	Type	Reset	Description
5-4	VAD_CH_SEL[1:0]	R/W	10b	VAD channel select. 0d = Channel 1 is monitored for VAD activity 1d = Channel 2 is monitored for VAD activity 2d = Channel 3 is monitored for VAD activity 3d = Channel 4 is monitored for VAD activity
3-2	VAD_CLK_CFG[1:0]	R/W	00b	Clock select for VAD 0d = VAD processing using internal oscillator clock 1d = VAD processing using external clock on BCLK input 2d = VAD processing using external clock on MCLK input 3d = Custom clock configuration based on MST_CFG, CLK_SRC and CLKGEN_CFG registers in page 0
1-0	VAD_EXT_CLK_CFG[1:0]	R/W	00b	Clock configuration using external clock for VAD. 0d = External clock is 3.072 MHz 1d = External clock is 6.144 MHz 2d = External clock is 12.288 MHz 3d = External clock is 18.432 MHz

8.6.3.3 VAD_CFG2 Register (Address = 0x1F) [Reset = 0x8]

VAD_CFG2 is shown in 图 8-73 and described in 表 8-115.

Return to the 表 8-112.

This register is configuration register 2 for voice activity detection.

图 8-73. VAD_CFG2 Register

7	6	5	4	3	2	1	0
RESERVED	SDOUT_INT_CFG	RESERVED	RESERVED	VAD_PD_DET_EN	RESERVED		
R/W-0b	R/W-0b	R-0b	R/W-0b	R/W-1b	R-000b		

表 8-115. VAD_CFG2 Register Field Descriptions

Bit	Field	Type	Reset	Description
7	RESERVED	R/W	0b	Reserved bit; Write only reset value
6	SDOUT_INT_CFG	R/W	0b	SDOUT interrupt configuration. 0d = SDOUT pin is not enabled for interrupt function 1d = SDOUT pin is enabled to support interrupt output when channel data is not being recorded
5	RESERVED	R	0b	Reserved bit; Write only reset value
4	RESERVED	R/W	0b	Reserved bit; Write only reset value
3	VAD_PD_DET_EN	R/W	1b	Enable ASI output data during VAD activity. 0d = VAD processing is not enabled during ADC recording 1d = VAD processing is enabled during ADC recording and VAD interrupts are generated as configured
2-0	RESERVED	R	000b	Reserved bits; Write only reset values

8.6.4 Programmable Coefficient Registers

8.6.4.1 Programmable Coefficient Registers: Page 2

This register page (shown in [表 8-116](#)) consists of the programmable coefficients for the biquad 1 to biquad 6 filters. To optimize the coefficients register transaction time for page 2, page 3, and page 4, the device also supports (by default) auto-incremented pages for the I²C writes and reads. After a transaction of register address 0x7F, the device auto increments to the next page at register 0x08 to transact the next coefficient value.

表 8-116. Page 2 Programmable Coefficient Registers

ADDRESS	ACRONYM	REGISTER NAME	RESET VALUE
0x00	PAGE[7:0]	Device page register	0x00
0x08	BQ1_N0_BYT1[7:0]	Programmable biquad 1, N0 coefficient byte[31:24]	0x7F
0x09	BQ1_N0_BYT2[7:0]	Programmable biquad 1, N0 coefficient byte[23:16]	0xFF
0x0A	BQ1_N0_BYT3[7:0]	Programmable biquad 1, N0 coefficient byte[15:8]	0xFF
0x0B	BQ1_N0_BYT4[7:0]	Programmable biquad 1, N0 coefficient byte[7:0]	0xFF
0x0C	BQ1_N1_BYT1[7:0]	Programmable biquad 1, N1 coefficient byte[31:24]	0x00
0x0D	BQ1_N1_BYT2[7:0]	Programmable biquad 1, N1 coefficient byte[23:16]	0x00
0x0E	BQ1_N1_BYT3[7:0]	Programmable biquad 1, N1 coefficient byte[15:8]	0x00
0x0F	BQ1_N1_BYT4[7:0]	Programmable biquad 1, N1 coefficient byte[7:0]	0x00
0x10	BQ1_N2_BYT1[7:0]	Programmable biquad 1, N2 coefficient byte[31:24]	0x00
0x11	BQ1_N2_BYT2[7:0]	Programmable biquad 1, N2 coefficient byte[23:16]	0x00
0x12	BQ1_N2_BYT3[7:0]	Programmable biquad 1, N2 coefficient byte[15:8]	0x00
0x13	BQ1_N2_BYT4[7:0]	Programmable biquad 1, N2 coefficient byte[7:0]	0x00
0x14	BQ1_D1_BYT1[7:0]	Programmable biquad 1, D1 coefficient byte[31:24]	0x00
0x15	BQ1_D1_BYT2[7:0]	Programmable biquad 1, D1 coefficient byte[23:16]	0x00
0x16	BQ1_D1_BYT3[7:0]	Programmable biquad 1, D1 coefficient byte[15:8]	0x00
0x17	BQ1_D1_BYT4[7:0]	Programmable biquad 1, D1 coefficient byte[7:0]	0x00
0x18	BQ1_D2_BYT1[7:0]	Programmable biquad 1, D2 coefficient byte[31:24]	0x00
0x19	BQ1_D2_BYT2[7:0]	Programmable biquad 1, D2 coefficient byte[23:16]	0x00
0x1A	BQ1_D2_BYT3[7:0]	Programmable biquad 1, D2 coefficient byte[15:8]	0x00
0x1B	BQ1_D2_BYT4[7:0]	Programmable biquad 1, D2 coefficient byte[7:0]	0x00
0x1C	BQ2_N0_BYT1[7:0]	Programmable biquad 2, N0 coefficient byte[31:24]	0x7F
0x1D	BQ2_N0_BYT2[7:0]	Programmable biquad 2, N0 coefficient byte[23:16]	0xFF
0x1E	BQ2_N0_BYT3[7:0]	Programmable biquad 2, N0 coefficient byte[15:8]	0xFF
0x1F	BQ2_N0_BYT4[7:0]	Programmable biquad 2, N0 coefficient byte[7:0]	0xFF
0x20	BQ2_N1_BYT1[7:0]	Programmable biquad 2, N1 coefficient byte[31:24]	0x00
0x21	BQ2_N1_BYT2[7:0]	Programmable biquad 2, N1 coefficient byte[23:16]	0x00
0x22	BQ2_N1_BYT3[7:0]	Programmable biquad 2, N1 coefficient byte[15:8]	0x00
0x23	BQ2_N1_BYT4[7:0]	Programmable biquad 2, N1 coefficient byte[7:0]	0x00
0x24	BQ2_N2_BYT1[7:0]	Programmable biquad 2, N2 coefficient byte[31:24]	0x00
0x25	BQ2_N2_BYT2[7:0]	Programmable biquad 2, N2 coefficient byte[23:16]	0x00
0x26	BQ2_N2_BYT3[7:0]	Programmable biquad 2, N2 coefficient byte[15:8]	0x00
0x27	BQ2_N2_BYT4[7:0]	Programmable biquad 2, N2 coefficient byte[7:0]	0x00
0x28	BQ2_D1_BYT1[7:0]	Programmable biquad 2, D1 coefficient byte[31:24]	0x00
0x29	BQ2_D1_BYT2[7:0]	Programmable biquad 2, D1 coefficient byte[23:16]	0x00
0x2A	BQ2_D1_BYT3[7:0]	Programmable biquad 2, D1 coefficient byte[15:8]	0x00
0x2B	BQ2_D1_BYT4[7:0]	Programmable biquad 2, D1 coefficient byte[7:0]	0x00
0x2C	BQ2_D2_BYT1[7:0]	Programmable biquad 2, D2 coefficient byte[31:24]	0x00
0x2D	BQ2_D2_BYT2[7:0]	Programmable biquad 2, D2 coefficient byte[23:16]	0x00
0x2E	BQ2_D2_BYT3[7:0]	Programmable biquad 2, D2 coefficient byte[15:8]	0x00
0x2F	BQ2_D2_BYT4[7:0]	Programmable biquad 2, D2 coefficient byte[7:0]	0x00
0x30	BQ3_N0_BYT1[7:0]	Programmable biquad 3, N0 coefficient byte[31:24]	0x7F
0x31	BQ3_N0_BYT2[7:0]	Programmable biquad 3, N0 coefficient byte[23:16]	0xFF

表 8-116. Page 2 Programmable Coefficient Registers (continued)

ADDRESS	ACRONYM	REGISTER NAME	RESET VALUE
0x32	BQ3_N0_BYT3[7:0]	Programmable biquad 3, N0 coefficient byte[15:8]	0xFF
0x33	BQ3_N0_BYT4[7:0]	Programmable biquad 3, N0 coefficient byte[7:0]	0xFF
0x34	BQ3_N1_BYT1[7:0]	Programmable biquad 3, N1 coefficient byte[31:24]	0x00
0x35	BQ3_N1_BYT2[7:0]	Programmable biquad 3, N1 coefficient byte[23:16]	0x00
0x36	BQ3_N1_BYT3[7:0]	Programmable biquad 3, N1 coefficient byte[15:8]	0x00
0x37	BQ3_N1_BYT4[7:0]	Programmable biquad 3, N1 coefficient byte[7:0]	0x00
0x38	BQ3_N2_BYT1[7:0]	Programmable biquad 3, N2 coefficient byte[31:24]	0x00
0x39	BQ3_N2_BYT2[7:0]	Programmable biquad 3, N2 coefficient byte[23:16]	0x00
0x3A	BQ3_N2_BYT3[7:0]	Programmable biquad 3, N2 coefficient byte[15:8]	0x00
0x3B	BQ3_N2_BYT4[7:0]	Programmable biquad 3, N2 coefficient byte[7:0]	0x00
0x3C	BQ3_D1_BYT1[7:0]	Programmable biquad 3, D1 coefficient byte[31:24]	0x00
0x3D	BQ3_D1_BYT2[7:0]	Programmable biquad 3, D1 coefficient byte[23:16]	0x00
0x3E	BQ3_D1_BYT3[7:0]	Programmable biquad 3, D1 coefficient byte[15:8]	0x00
0x3F	BQ3_D1_BYT4[7:0]	Programmable biquad 3, D1 coefficient byte[7:0]	0x00
0x40	BQ3_D2_BYT1[7:0]	Programmable biquad 3, D2 coefficient byte[31:24]	0x00
0x41	BQ3_D2_BYT2[7:0]	Programmable biquad 3, D2 coefficient byte[23:16]	0x00
0x42	BQ3_D2_BYT3[7:0]	Programmable biquad 3, D2 coefficient byte[15:8]	0x00
0x43	BQ3_D2_BYT4[7:0]	Programmable biquad 3, D2 coefficient byte[7:0]	0x00
0x44	BQ4_N0_BYT1[7:0]	Programmable biquad 4, N0 coefficient byte[31:24]	0x7F
0x45	BQ4_N0_BYT2[7:0]	Programmable biquad 4, N0 coefficient byte[23:16]	0xFF
0x46	BQ4_N0_BYT3[7:0]	Programmable biquad 4, N0 coefficient byte[15:8]	0xFF
0x47	BQ4_N0_BYT4[7:0]	Programmable biquad 4, N0 coefficient byte[7:0]	0xFF
0x48	BQ4_N1_BYT1[7:0]	Programmable biquad 4, N1 coefficient byte[31:24]	0x00
0x49	BQ4_N1_BYT2[7:0]	Programmable biquad 4, N1 coefficient byte[23:16]	0x00
0x4A	BQ4_N1_BYT3[7:0]	Programmable biquad 4, N1 coefficient byte[15:8]	0x00
0x4B	BQ4_N1_BYT4[7:0]	Programmable biquad 4, N1 coefficient byte[7:0]	0x00
0x4C	BQ4_N2_BYT1[7:0]	Programmable biquad 4, N2 coefficient byte[31:24]	0x00
0x4D	BQ4_N2_BYT2[7:0]	Programmable biquad 4, N2 coefficient byte[23:16]	0x00
0x4E	BQ4_N2_BYT3[7:0]	Programmable biquad 4, N2 coefficient byte[15:8]	0x00
0x4F	BQ4_N2_BYT4[7:0]	Programmable biquad 4, N2 coefficient byte[7:0]	0x00
0x50	BQ4_D1_BYT1[7:0]	Programmable biquad 4, D1 coefficient byte[31:24]	0x00
0x51	BQ4_D1_BYT2[7:0]	Programmable biquad 4, D1 coefficient byte[23:16]	0x00
0x52	BQ4_D1_BYT3[7:0]	Programmable biquad 4, D1 coefficient byte[15:8]	0x00
0x53	BQ4_D1_BYT4[7:0]	Programmable biquad 4, D1 coefficient byte[7:0]	0x00
0x54	BQ4_D2_BYT1[7:0]	Programmable biquad 4, D2 coefficient byte[31:24]	0x00
0x55	BQ4_D2_BYT2[7:0]	Programmable biquad 4, D2 coefficient byte[23:16]	0x00
0x56	BQ4_D2_BYT3[7:0]	Programmable biquad 4, D2 coefficient byte[15:8]	0x00
0x57	BQ4_D2_BYT4[7:0]	Programmable biquad 4, D2 coefficient byte[7:0]	0x00
0x58	BQ5_N0_BYT1[7:0]	Programmable biquad 5, N0 coefficient byte[31:24]	0x7F
0x59	BQ5_N0_BYT2[7:0]	Programmable biquad 5, N0 coefficient byte[23:16]	0xFF
0x5A	BQ5_N0_BYT3[7:0]	Programmable biquad 5, N0 coefficient byte[15:8]	0xFF
0x5B	BQ5_N0_BYT4[7:0]	Programmable biquad 5, N0 coefficient byte[7:0]	0xFF
0x5C	BQ5_N1_BYT1[7:0]	Programmable biquad 5, N1 coefficient byte[31:24]	0x00
0x5D	BQ5_N1_BYT2[7:0]	Programmable biquad 5, N1 coefficient byte[23:16]	0x00
0x5E	BQ5_N1_BYT3[7:0]	Programmable biquad 5, N1 coefficient byte[15:8]	0x00
0x5F	BQ5_N1_BYT4[7:0]	Programmable biquad 5, N1 coefficient byte[7:0]	0x00
0x60	BQ5_N2_BYT1[7:0]	Programmable biquad 5, N2 coefficient byte[31:24]	0x00
0x61	BQ5_N2_BYT2[7:0]	Programmable biquad 5, N2 coefficient byte[23:16]	0x00
0x62	BQ5_N2_BYT3[7:0]	Programmable biquad 5, N2 coefficient byte[15:8]	0x00
0x63	BQ5_N2_BYT4[7:0]	Programmable biquad 5, N2 coefficient byte[7:0]	0x00

表 8-116. Page 2 Programmable Coefficient Registers (continued)

ADDRESS	ACRONYM	REGISTER NAME	RESET VALUE
0x64	BQ5_D1_BYT1[7:0]	Programmable biquad 5, D1 coefficient byte[31:24]	0x00
0x65	BQ5_D1_BYT2[7:0]	Programmable biquad 5, D1 coefficient byte[23:16]	0x00
0x66	BQ5_D1_BYT3[7:0]	Programmable biquad 5, D1 coefficient byte[15:8]	0x00
0x67	BQ5_D1_BYT4[7:0]	Programmable biquad 5, D1 coefficient byte[7:0]	0x00
0x68	BQ5_D2_BYT1[7:0]	Programmable biquad 5, D2 coefficient byte[31:24]	0x00
0x69	BQ5_D2_BYT2[7:0]	Programmable biquad 5, D2 coefficient byte[23:16]	0x00
0x6A	BQ5_D2_BYT3[7:0]	Programmable biquad 5, D2 coefficient byte[15:8]	0x00
0x6B	BQ5_D2_BYT4[7:0]	Programmable biquad 5, D2 coefficient byte[7:0]	0x00
0x6C	BQ6_N0_BYT1[7:0]	Programmable biquad 6, N0 coefficient byte[31:24]	0x7F
0x6D	BQ6_N0_BYT2[7:0]	Programmable biquad 6, N0 coefficient byte[23:16]	0xFF
0x6E	BQ6_N0_BYT3[7:0]	Programmable biquad 6, N0 coefficient byte[15:8]	0xFF
0x6F	BQ6_N0_BYT4[7:0]	Programmable biquad 6, N0 coefficient byte[7:0]	0xFF
0x70	BQ6_N1_BYT1[7:0]	Programmable biquad 6, N1 coefficient byte[31:24]	0x00
0x71	BQ6_N1_BYT2[7:0]	Programmable biquad 6, N1 coefficient byte[23:16]	0x00
0x72	BQ6_N1_BYT3[7:0]	Programmable biquad 6, N1 coefficient byte[15:8]	0x00
0x73	BQ6_N1_BYT4[7:0]	Programmable biquad 6, N1 coefficient byte[7:0]	0x00
0x74	BQ6_N2_BYT1[7:0]	Programmable biquad 6, N2 coefficient byte[31:24]	0x00
0x75	BQ6_N2_BYT2[7:0]	Programmable biquad 6, N2 coefficient byte[23:16]	0x00
0x76	BQ6_N2_BYT3[7:0]	Programmable biquad 6, N2 coefficient byte[15:8]	0x00
0x77	BQ6_N2_BYT4[7:0]	Programmable biquad 6, N2 coefficient byte[7:0]	0x00
0x78	BQ6_D1_BYT1[7:0]	Programmable biquad 6, D1 coefficient byte[31:24]	0x00
0x79	BQ6_D1_BYT2[7:0]	Programmable biquad 6, D1 coefficient byte[23:16]	0x00
0x7A	BQ6_D1_BYT3[7:0]	Programmable biquad 6, D1 coefficient byte[15:8]	0x00
0x7B	BQ6_D1_BYT4[7:0]	Programmable biquad 6, D1 coefficient byte[7:0]	0x00
0x7C	BQ6_D2_BYT1[7:0]	Programmable biquad 6, D2 coefficient byte[31:24]	0x00
0x7D	BQ6_D2_BYT2[7:0]	Programmable biquad 6, D2 coefficient byte[23:16]	0x00
0x7E	BQ6_D2_BYT3[7:0]	Programmable biquad 6, D2 coefficient byte[15:8]	0x00
0x7F	BQ6_D2_BYT4[7:0]	Programmable biquad 6, D2 coefficient byte[7:0]	0x00

8.6.4.2 Programmable Coefficient Registers: Page 3

This register page (shown in 表 8-117) consists of the programmable coefficients for the biquad 7 to biquad 12 filters. To optimize the coefficients register transaction time for page 2, page 3, and page 4, the device also supports (by default) auto-incremented pages for the I²C writes and reads. After a transaction of register address 0x7F, the device auto increments to the next page at register 0x08 to transact the next coefficient value.

表 8-117. Page 3 Programmable Coefficient Registers

ADDRESS	ACRONYM	REGISTER NAME	RESET VALUE
0x00	PAGE[7:0]	Device page register	0x00
0x08	BQ7_N0_BYT1[7:0]	Programmable biquad 7, N0 coefficient byte[31:24]	0x7F
0x09	BQ7_N0_BYT2[7:0]	Programmable biquad 7, N0 coefficient byte[23:16]	0xFF
0x0A	BQ7_N0_BYT3[7:0]	Programmable biquad 7, N0 coefficient byte[15:8]	0xFF
0x0B	BQ7_N0_BYT4[7:0]	Programmable biquad 7, N0 coefficient byte[7:0]	0xFF
0x0C	BQ7_N1_BYT1[7:0]	Programmable biquad 7, N1 coefficient byte[31:24]	0x00
0x0D	BQ7_N1_BYT2[7:0]	Programmable biquad 7, N1 coefficient byte[23:16]	0x00
0x0E	BQ7_N1_BYT3[7:0]	Programmable biquad 7, N1 coefficient byte[15:8]	0x00
0x0F	BQ7_N1_BYT4[7:0]	Programmable biquad 7, N1 coefficient byte[7:0]	0x00
0x10	BQ7_N2_BYT1[7:0]	Programmable biquad 7, N2 coefficient byte[31:24]	0x00
0x11	BQ7_N2_BYT2[7:0]	Programmable biquad 7, N2 coefficient byte[23:16]	0x00
0x12	BQ7_N2_BYT3[7:0]	Programmable biquad 7, N2 coefficient byte[15:8]	0x00
0x13	BQ7_N2_BYT4[7:0]	Programmable biquad 7, N2 coefficient byte[7:0]	0x00
0x14	BQ7_D1_BYT1[7:0]	Programmable biquad 7, D1 coefficient byte[31:24]	0x00
0x15	BQ7_D1_BYT2[7:0]	Programmable biquad 7, D1 coefficient byte[23:16]	0x00
0x16	BQ7_D1_BYT3[7:0]	Programmable biquad 7, D1 coefficient byte[15:8]	0x00
0x17	BQ7_D1_BYT4[7:0]	Programmable biquad 7, D1 coefficient byte[7:0]	0x00
0x18	BQ7_D2_BYT1[7:0]	Programmable biquad 7, D2 coefficient byte[31:24]	0x00
0x19	BQ7_D2_BYT2[7:0]	Programmable biquad 7, D2 coefficient byte[23:16]	0x00
0x1A	BQ7_D2_BYT3[7:0]	Programmable biquad 7, D2 coefficient byte[15:8]	0x00
0x1B	BQ7_D2_BYT4[7:0]	Programmable biquad 7, D2 coefficient byte[7:0]	0x00
0x1C	BQ8_N0_BYT1[7:0]	Programmable biquad 8, N0 coefficient byte[31:24]	0x7F
0x1D	BQ8_N0_BYT2[7:0]	Programmable biquad 8, N0 coefficient byte[23:16]	0xFF
0x1E	BQ8_N0_BYT3[7:0]	Programmable biquad 8, N0 coefficient byte[15:8]	0xFF
0x1F	BQ8_N0_BYT4[7:0]	Programmable biquad 8, N0 coefficient byte[7:0]	0xFF
0x20	BQ8_N1_BYT1[7:0]	Programmable biquad 8, N1 coefficient byte[31:24]	0x00
0x21	BQ8_N1_BYT2[7:0]	Programmable biquad 8, N1 coefficient byte[23:16]	0x00
0x22	BQ8_N1_BYT3[7:0]	Programmable biquad 8, N1 coefficient byte[15:8]	0x00
0x23	BQ8_N1_BYT4[7:0]	Programmable biquad 8, N1 coefficient byte[7:0]	0x00
0x24	BQ8_N2_BYT1[7:0]	Programmable biquad 8, N2 coefficient byte[31:24]	0x00
0x25	BQ8_N2_BYT2[7:0]	Programmable biquad 8, N2 coefficient byte[23:16]	0x00
0x26	BQ8_N2_BYT3[7:0]	Programmable biquad 8, N2 coefficient byte[15:8]	0x00
0x27	BQ8_N2_BYT4[7:0]	Programmable biquad 8, N2 coefficient byte[7:0]	0x00
0x28	BQ8_D1_BYT1[7:0]	Programmable biquad 8, D1 coefficient byte[31:24]	0x00
0x29	BQ8_D1_BYT2[7:0]	Programmable biquad 8, D1 coefficient byte[23:16]	0x00
0x2A	BQ8_D1_BYT3[7:0]	Programmable biquad 8, D1 coefficient byte[15:8]	0x00
0x2B	BQ8_D1_BYT4[7:0]	Programmable biquad 8, D1 coefficient byte[7:0]	0x00
0x2C	BQ8_D2_BYT1[7:0]	Programmable biquad 8, D2 coefficient byte[31:24]	0x00
0x2D	BQ8_D2_BYT2[7:0]	Programmable biquad 8, D2 coefficient byte[23:16]	0x00
0x2E	BQ8_D2_BYT3[7:0]	Programmable biquad 8, D2 coefficient byte[15:8]	0x00
0x2F	BQ8_D2_BYT4[7:0]	Programmable biquad 8, D2 coefficient byte[7:0]	0x00
0x30	BQ9_N0_BYT1[7:0]	Programmable biquad 9, N0 coefficient byte[31:24]	0x7F
0x31	BQ9_N0_BYT2[7:0]	Programmable biquad 9, N0 coefficient byte[23:16]	0xFF
0x32	BQ9_N0_BYT3[7:0]	Programmable biquad 9, N0 coefficient byte[15:8]	0xFF

表 8-117. Page 3 Programmable Coefficient Registers (continued)

ADDRESS	ACRONYM	REGISTER NAME	RESET VALUE
0x33	BQ9_N0_BYT4[7:0]	Programmable biquad 9, N0 coefficient byte[7:0]	0xFF
0x34	BQ9_N1_BYT1[7:0]	Programmable biquad 9, N1 coefficient byte[31:24]	0x00
0x35	BQ9_N1_BYT2[7:0]	Programmable biquad 9, N1 coefficient byte[23:16]	0x00
0x36	BQ9_N1_BYT3[7:0]	Programmable biquad 9, N1 coefficient byte[15:8]	0x00
0x37	BQ9_N1_BYT4[7:0]	Programmable biquad 9, N1 coefficient byte[7:0]	0x00
0x38	BQ9_N2_BYT1[7:0]	Programmable biquad 9, N2 coefficient byte[31:24]	0x00
0x39	BQ9_N2_BYT2[7:0]	Programmable biquad 9, N2 coefficient byte[23:16]	0x00
0x3A	BQ9_N2_BYT3[7:0]	Programmable biquad 9, N2 coefficient byte[15:8]	0x00
0x3B	BQ9_N2_BYT4[7:0]	Programmable biquad 9, N2 coefficient byte[7:0]	0x00
0x3C	BQ9_D1_BYT1[7:0]	Programmable biquad 9, D1 coefficient byte[31:24]	0x00
0x3D	BQ9_D1_BYT2[7:0]	Programmable biquad 9, D1 coefficient byte[23:16]	0x00
0x3E	BQ9_D1_BYT3[7:0]	Programmable biquad 9, D1 coefficient byte[15:8]	0x00
0x3F	BQ9_D1_BYT4[7:0]	Programmable biquad 9, D1 coefficient byte[7:0]	0x00
0x40	BQ9_D2_BYT1[7:0]	Programmable biquad 9, D2 coefficient byte[31:24]	0x00
0x41	BQ9_D2_BYT2[7:0]	Programmable biquad 9, D2 coefficient byte[23:16]	0x00
0x42	BQ9_D2_BYT3[7:0]	Programmable biquad 9, D2 coefficient byte[15:8]	0x00
0x43	BQ9_D2_BYT4[7:0]	Programmable biquad 9, D2 coefficient byte[7:0]	0x00
0x44	BQ10_N0_BYT1[7:0]	Programmable biquad 10, N0 coefficient byte[31:24]	0x7F
0x45	BQ10_N0_BYT2[7:0]	Programmable biquad 10, N0 coefficient byte[23:16]	0xFF
0x46	BQ10_N0_BYT3[7:0]	Programmable biquad 10, N0 coefficient byte[15:8]	0xFF
0x47	BQ10_N0_BYT4[7:0]	Programmable biquad 10, N0 coefficient byte[7:0]	0xFF
0x48	BQ10_N1_BYT1[7:0]	Programmable biquad 10, N1 coefficient byte[31:24]	0x00
0x49	BQ10_N1_BYT2[7:0]	Programmable biquad 10, N1 coefficient byte[23:16]	0x00
0x4A	BQ10_N1_BYT3[7:0]	Programmable biquad 10, N1 coefficient byte[15:8]	0x00
0x4B	BQ10_N1_BYT4[7:0]	Programmable biquad 10, N1 coefficient byte[7:0]	0x00
0x4C	BQ10_N2_BYT1[7:0]	Programmable biquad 10, N2 coefficient byte[31:24]	0x00
0x4D	BQ10_N2_BYT2[7:0]	Programmable biquad 10, N2 coefficient byte[23:16]	0x00
0x4E	BQ10_N2_BYT3[7:0]	Programmable biquad 10, N2 coefficient byte[15:8]	0x00
0x4F	BQ10_N2_BYT4[7:0]	Programmable biquad 10, N2 coefficient byte[7:0]	0x00
0x50	BQ10_D1_BYT1[7:0]	Programmable biquad 10, D1 coefficient byte[31:24]	0x00
0x51	BQ10_D1_BYT2[7:0]	Programmable biquad 10, D1 coefficient byte[23:16]	0x00
0x52	BQ10_D1_BYT3[7:0]	Programmable biquad 10, D1 coefficient byte[15:8]	0x00
0x53	BQ10_D1_BYT4[7:0]	Programmable biquad 10, D1 coefficient byte[7:0]	0x00
0x54	BQ10_D2_BYT1[7:0]	Programmable biquad 10, D2 coefficient byte[31:24]	0x00
0x55	BQ10_D2_BYT2[7:0]	Programmable biquad 10, D2 coefficient byte[23:16]	0x00
0x56	BQ10_D2_BYT3[7:0]	Programmable biquad 10, D2 coefficient byte[15:8]	0x00
0x57	BQ10_D2_BYT4[7:0]	Programmable biquad 10, D2 coefficient byte[7:0]	0x00
0x58	BQ11_N0_BYT1[7:0]	Programmable biquad 11, N0 coefficient byte[31:24]	0x7F
0x59	BQ11_N0_BYT2[7:0]	Programmable biquad 11, N0 coefficient byte[23:16]	0xFF
0x5A	BQ11_N0_BYT3[7:0]	Programmable biquad 11, N0 coefficient byte[15:8]	0xFF
0x5B	BQ11_N0_BYT4[7:0]	Programmable biquad 11, N0 coefficient byte[7:0]	0xFF
0x5C	BQ11_N1_BYT1[7:0]	Programmable biquad 11, N1 coefficient byte[31:24]	0x00
0x5D	BQ11_N1_BYT2[7:0]	Programmable biquad 11, N1 coefficient byte[23:16]	0x00
0x5E	BQ11_N1_BYT3[7:0]	Programmable biquad 11, N1 coefficient byte[15:8]	0x00
0x5F	BQ11_N1_BYT4[7:0]	Programmable biquad 11, N1 coefficient byte[7:0]	0x00
0x60	BQ11_N2_BYT1[7:0]	Programmable biquad 11, N2 coefficient byte[31:24]	0x00
0x61	BQ11_N2_BYT2[7:0]	Programmable biquad 11, N2 coefficient byte[23:16]	0x00
0x62	BQ11_N2_BYT3[7:0]	Programmable biquad 11, N2 coefficient byte[15:8]	0x00
0x63	BQ11_N2_BYT4[7:0]	Programmable biquad 11, N2 coefficient byte[7:0]	0x00
0x64	BQ11_D1_BYT1[7:0]	Programmable biquad 11, D1 coefficient byte[31:24]	0x00

表 8-117. Page 3 Programmable Coefficient Registers (continued)

ADDRESS	ACRONYM	REGISTER NAME	RESET VALUE
0x65	BQ11_D1_BYT2[7:0]	Programmable biquad 11, D1 coefficient byte[23:16]	0x00
0x66	BQ11_D1_BYT3[7:0]	Programmable biquad 11, D1 coefficient byte[15:8]	0x00
0x67	BQ11_D1_BYT4[7:0]	Programmable biquad 11, D1 coefficient byte[7:0]	0x00
0x68	BQ11_D2_BYT1[7:0]	Programmable biquad 11, D2 coefficient byte[31:24]	0x00
0x69	BQ11_D2_BYT2[7:0]	Programmable biquad 11, D2 coefficient byte[23:16]	0x00
0x6A	BQ11_D2_BYT3[7:0]	Programmable biquad 11, D2 coefficient byte[15:8]	0x00
0x6B	BQ11_D2_BYT4[7:0]	Programmable biquad 11, D2 coefficient byte[7:0]	0x00
0x6C	BQ12_N0_BYT1[7:0]	Programmable biquad 12, N0 coefficient byte[31:24]	0x7F
0x6D	BQ12_N0_BYT2[7:0]	Programmable biquad 12, N0 coefficient byte[23:16]	0xFF
0x6E	BQ12_N0_BYT3[7:0]	Programmable biquad 12, N0 coefficient byte[15:8]	0xFF
0x6F	BQ12_N0_BYT4[7:0]	Programmable biquad 12, N0 coefficient byte[7:0]	0xFF
0x70	BQ12_N1_BYT1[7:0]	Programmable biquad 12, N1 coefficient byte[31:24]	0x00
0x71	BQ12_N1_BYT2[7:0]	Programmable biquad 12, N1 coefficient byte[23:16]	0x00
0x72	BQ12_N1_BYT3[7:0]	Programmable biquad 12, N1 coefficient byte[15:8]	0x00
0x73	BQ12_N1_BYT4[7:0]	Programmable biquad 12, N1 coefficient byte[7:0]	0x00
0x74	BQ12_N2_BYT1[7:0]	Programmable biquad 12, N2 coefficient byte[31:24]	0x00
0x75	BQ12_N2_BYT2[7:0]	Programmable biquad 12, N2 coefficient byte[23:16]	0x00
0x76	BQ12_N2_BYT3[7:0]	Programmable biquad 12, N2 coefficient byte[15:8]	0x00
0x77	BQ12_N2_BYT4[7:0]	Programmable biquad 12, N2 coefficient byte[7:0]	0x00
0x78	BQ12_D1_BYT1[7:0]	Programmable biquad 12, D1 coefficient byte[31:24]	0x00
0x79	BQ12_D1_BYT2[7:0]	Programmable biquad 12, D1 coefficient byte[23:16]	0x00
0x7A	BQ12_D1_BYT3[7:0]	Programmable biquad 12, D1 coefficient byte[15:8]	0x00
0x7B	BQ12_D1_BYT4[7:0]	Programmable biquad 12, D1 coefficient byte[7:0]	0x00
0x7C	BQ12_D2_BYT1[7:0]	Programmable biquad 12, D2 coefficient byte[31:24]	0x00
0x7D	BQ12_D2_BYT2[7:0]	Programmable biquad 12, D2 coefficient byte[23:16]	0x00
0x7E	BQ12_D2_BYT3[7:0]	Programmable biquad 12, D2 coefficient byte[15:8]	0x00
0x7F	BQ12_D2_BYT4[7:0]	Programmable biquad 12, D2 coefficient byte[7:0]	0x00

8.6.4.3 Programmable Coefficient Registers: Page 4

This register page (shown in 表 8-118) consists of the programmable coefficients for mixer 1 to mixer 4 and the first-order IIR filter.

表 8-118. Page 4 Programmable Coefficient Registers

ADDRESS	ACRONYM	REGISTER NAME	RESET VALUE
0x00	PAGE[7:0]	Device page register	0x00
0x08	MIX1_CH1_BYT1[7:0]	Digital mixer 1, channel 1 coefficient byte[31:24]	0x7F
0x09	MIX1_CH1_BYT2[7:0]	Digital mixer 1, channel 1 coefficient byte[23:16]	0xFF
0x0A	MIX1_CH1_BYT3[7:0]	Digital mixer 1, channel 1 coefficient byte[15:8]	0xFF
0x0B	MIX1_CH1_BYT4[7:0]	Digital mixer 1, channel 1 coefficient byte[7:0]	0xFF
0x0C	MIX1_CH2_BYT1[7:0]	Digital mixer 1, channel 2 coefficient byte[31:24]	0x00
0x0D	MIX1_CH2_BYT2[7:0]	Digital mixer 1, channel 2 coefficient byte[23:16]	0x00
0x0E	MIX1_CH2_BYT3[7:0]	Digital mixer 1, channel 2 coefficient byte[15:8]	0x00
0x0F	MIX1_CH2_BYT4[7:0]	Digital mixer 1, channel 2 coefficient byte[7:0]	0x00
0x10	MIX1_CH3_BYT1[7:0]	Digital mixer 1, channel 3 coefficient byte[31:24]	0x00
0x11	MIX1_CH3_BYT2[7:0]	Digital mixer 1, channel 3 coefficient byte[23:16]	0x00
0x12	MIX1_CH3_BYT3[7:0]	Digital mixer 1, channel 3 coefficient byte[15:8]	0x00
0x13	MIX1_CH3_BYT4[7:0]	Digital mixer 1, channel 3 coefficient byte[7:0]	0x00
0x14	MIX1_CH4_BYT1[7:0]	Digital mixer 1, channel 4 coefficient byte[31:24]	0x00
0x15	MIX1_CH4_BYT2[7:0]	Digital mixer 1, channel 4 coefficient byte[23:16]	0x00
0x16	MIX1_CH4_BYT3[7:0]	Digital mixer 1, channel 4 coefficient byte[15:8]	0x00
0x17	MIX1_CH4_BYT4[7:0]	Digital mixer 1, channel 4 coefficient byte[7:0]	0x00
0x18	MIX2_CH1_BYT1[7:0]	Digital mixer 2, channel 1 coefficient byte[31:24]	0x00
0x19	MIX2_CH1_BYT2[7:0]	Digital mixer 2, channel 1 coefficient byte[23:16]	0x00
0x1A	MIX2_CH1_BYT3[7:0]	Digital mixer 2, channel 1 coefficient byte[15:8]	0x00
0x1B	MIX2_CH1_BYT4[7:0]	Digital mixer 2, channel 1 coefficient byte[7:0]	0x00
0x1C	MIX2_CH2_BYT1[7:0]	Digital mixer 2, channel 2 coefficient byte[31:24]	0x7F
0x1D	MIX2_CH2_BYT2[7:0]	Digital mixer 2, channel 2 coefficient byte[23:16]	0xFF
0x1E	MIX2_CH2_BYT3[7:0]	Digital mixer 2, channel 2 coefficient byte[15:8]	0xFF
0x1F	MIX2_CH2_BYT4[7:0]	Digital mixer 2, channel 2 coefficient byte[7:0]	0xFF
0x20	MIX2_CH3_BYT1[7:0]	Digital mixer 2, channel 3 coefficient byte[31:24]	0x00
0x21	MIX2_CH3_BYT2[7:0]	Digital mixer 2, channel 3 coefficient byte[23:16]	0x00
0x22	MIX2_CH3_BYT3[7:0]	Digital mixer 2, channel 3 coefficient byte[15:8]	0x00
0x23	MIX2_CH3_BYT4[7:0]	Digital mixer 2, channel 3 coefficient byte[7:0]	0x00
0x24	MIX2_CH4_BYT1[7:0]	Digital mixer 2, channel 4 coefficient byte[31:24]	0x00
0x25	MIX2_CH4_BYT2[7:0]	Digital mixer 2, channel 4 coefficient byte[23:16]	0x00
0x26	MIX2_CH4_BYT3[7:0]	Digital mixer 2, channel 4 coefficient byte[15:8]	0x00
0x27	MIX2_CH4_BYT4[7:0]	Digital mixer 2, channel 4 coefficient byte[7:0]	0x00
0x28	MIX3_CH1_BYT1[7:0]	Digital mixer 3, channel 1 coefficient byte[31:24]	0x00
0x29	MIX3_CH1_BYT2[7:0]	Digital mixer 3, channel 1 coefficient byte[23:16]	0x00
0x2A	MIX3_CH1_BYT3[7:0]	Digital mixer 3, channel 1 coefficient byte[15:8]	0x00
0x2B	MIX3_CH1_BYT4[7:0]	Digital mixer 3, channel 1 coefficient byte[7:0]	0x00
0x2C	MIX3_CH2_BYT1[7:0]	Digital mixer 3, channel 2 coefficient byte[31:24]	0x00
0x2D	MIX3_CH2_BYT2[7:0]	Digital mixer 3, channel 2 coefficient byte[23:16]	0x00
0x2E	MIX3_CH2_BYT3[7:0]	Digital mixer 3, channel 2 coefficient byte[15:8]	0x00
0x2F	MIX3_CH2_BYT4[7:0]	Digital mixer 3, channel 2 coefficient byte[7:0]	0x00
0x30	MIX3_CH3_BYT1[7:0]	Digital mixer 3, channel 3 coefficient byte[31:24]	0x7F
0x31	MIX3_CH3_BYT2[7:0]	Digital mixer 3, channel 3 coefficient byte[23:16]	0xFF
0x32	MIX3_CH3_BYT3[7:0]	Digital mixer 3, channel 3 coefficient byte[15:8]	0xFF
0x33	MIX3_CH3_BYT4[7:0]	Digital mixer 3, channel 3 coefficient byte[7:0]	0xFF
0x34	MIX3_CH4_BYT1[7:0]	Digital mixer 3, channel 4 coefficient byte[31:24]	0x00

表 8-118. Page 4 Programmable Coefficient Registers (continued)

ADDRESS	ACRONYM	REGISTER NAME	RESET VALUE
0x35	MIX3_CH4_BYT2[7:0]	Digital mixer 3, channel 4 coefficient byte[23:16]	0x00
0x36	MIX3_CH4_BYT3[7:0]	Digital mixer 3, channel 4 coefficient byte[15:8]	0x00
0x37	MIX3_CH4_BYT4[7:0]	Digital mixer 3, channel 4 coefficient byte[7:0]	0x00
0x38	MIX4_CH1_BYT1[7:0]	Digital mixer 4, channel 1 coefficient byte[31:24]	0x00
0x39	MIX4_CH1_BYT2[7:0]	Digital mixer 4, channel 1 coefficient byte[23:16]	0x00
0x3A	MIX4_CH1_BYT3[7:0]	Digital mixer 4, channel 1 coefficient byte[15:8]	0x00
0x3B	MIX4_CH1_BYT4[7:0]	Digital mixer 4, channel 1 coefficient byte[7:0]	0x00
0x3C	MIX4_CH2_BYT1[7:0]	Digital mixer 4, channel 2 coefficient byte[31:24]	0x00
0x3D	MIX4_CH2_BYT2[7:0]	Digital mixer 4, channel 2 coefficient byte[23:16]	0x00
0x3E	MIX4_CH2_BYT3[7:0]	Digital mixer 4, channel 2 coefficient byte[15:8]	0x00
0x3F	MIX4_CH2_BYT4[7:0]	Digital mixer 4, channel 2 coefficient byte[7:0]	0x00
0x40	MIX4_CH3_BYT1[7:0]	Digital mixer 4, channel 3 coefficient byte[31:24]	0x00
0x41	MIX4_CH3_BYT2[7:0]	Digital mixer 4, channel 3 coefficient byte[23:16]	0x00
0x42	MIX4_CH3_BYT3[7:0]	Digital mixer 4, channel 3 coefficient byte[15:8]	0x00
0x43	MIX4_CH3_BYT4[7:0]	Digital mixer 4, channel 3 coefficient byte[7:0]	0x00
0x44	MIX4_CH4_BYT1[7:0]	Digital mixer 4, channel 4 coefficient byte[31:24]	0x7F
0x45	MIX4_CH4_BYT2[7:0]	Digital mixer 4, channel 4 coefficient byte[23:16]	0xFF
0x46	MIX4_CH4_BYT3[7:0]	Digital mixer 4, channel 4 coefficient byte[15:8]	0xFF
0x47	MIX4_CH4_BYT4[7:0]	Digital mixer 4, channel 4 coefficient byte[7:0]	0xFF
0x48	IIR_N0_BYT1[7:0]	Programmable first-order IIR, N0 coefficient byte[31:24]	0x7F
0x49	IIR_N0_BYT2[7:0]	Programmable first-order IIR, N0 coefficient byte[23:16]	0xFF
0x4A	IIR_N0_BYT3[7:0]	Programmable first-order IIR, N0 coefficient byte[15:8]	0xFF
0x4B	IIR_N0_BYT4[7:0]	Programmable first-order IIR, N0 coefficient byte[7:0]	0xFF
0x4C	IIR_N1_BYT1[7:0]	Programmable first-order IIR, N1 coefficient byte[31:24]	0x00
0x4D	IIR_N1_BYT2[7:0]	Programmable first-order IIR, N1 coefficient byte[23:16]	0x00
0x4E	IIR_N1_BYT3[7:0]	Programmable first-order IIR, N1 coefficient byte[15:8]	0x00
0x4F	IIR_N1_BYT4[7:0]	Programmable first-order IIR, N1 coefficient byte[7:0]	0x00
0x50	IIR_D1_BYT1[7:0]	Programmable first-order IIR, D1 coefficient byte[31:24]	0x00
0x51	IIR_D1_BYT2[7:0]	Programmable first-order IIR, D1 coefficient byte[23:16]	0x00
0x52	IIR_D1_BYT3[7:0]	Programmable first-order IIR, D1 coefficient byte[15:8]	0x00
0x53	IIR_D1_BYT4[7:0]	Programmable first-order IIR, D1 coefficient byte[7:0]	0x00

9 Application and Implementation

备注

以下应用部分中的信息不属于 TI 器件规格的范围，TI 不担保其准确性和完整性。TI 的客户应负责确定器件是否适用于其应用。客户应验证并测试其设计，以确保系统功能。

9.1 Application Information

The PCM6120-Q1 is a multichannel, high-performance audio analog-to-digital converter (ADC) that supports output sample rates of up to 768 kHz. The device supports either up to two analog microphones or up to four digital pulse density modulation (PDM) microphones for simultaneous recording applications.

Communication to the PCM6120-Q1 for configuration of the control registers is supported using an I²C interface. The device supports a highly flexible, audio serial interface (TDM, I²S, and LJ) to transmit audio data seamlessly in the system across devices.

9.2 Typical Applications

9.2.1 Two-Channel Analog Microphone Recording

图 9-1 shows a typical configuration of the PCM6120-Q1 for an application using two analog microelectrical-mechanical system (MEMS) microphones for simultaneous recording operation with an I²C control interface and a time-division multiplexing (TDM) audio data slave interface. For best distortion performance, use input AC-coupling capacitors with a low-voltage coefficient.



图 9-1. Two-Channel Analog Microphone Recording Diagram

9.2.1.1 Design Requirements

表 9-1 lists the design parameters for this application.

表 9-1. Design Parameters

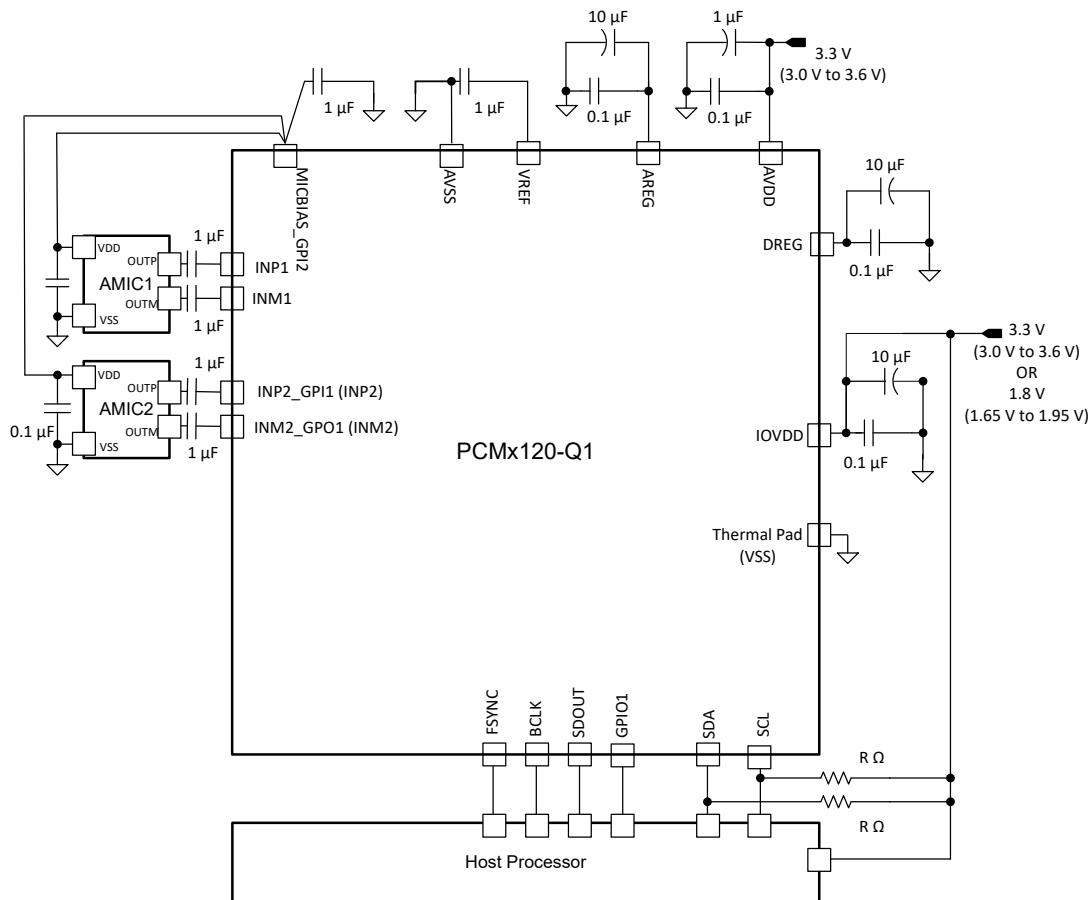
KEY PARAMETER	SPECIFICATION
AVDD	3.3 V
AVDD supply current consumption	>14 mA (PLL on, two-channel recording, $f_s = 48$ kHz)
IOVDD	1.8 V or 3.3 V
Maximum MICBIAS current	5 mA (MICBIAS voltage is the same as AVDD)

9.2.1.2 Detailed Design Procedure

This section describes the necessary steps to configure the PCM6120-Q1 for this specific application. The following steps provide a sequence of items that must be executed in the time between powering the device up and reading data from the device or transitioning from one mode to another mode of operation.

1. Apply power to the device:
 - a. Power-up the IOVDD and AVDD power supplies
 - b. Wait for at least 1 ms to allow the device to initialize the internal registers initialization
 - c. The device now goes into sleep mode (low-power mode < 10 μ A)
2. Transition from sleep mode to active mode whenever required for the recording operation:
 - a. Wake up the device by writing to P0_R2 to disable sleep mode
 - b. Wait for at least 1 ms to allow the device to complete the internal wake-up sequence
 - c. Override default configuration registers or programmable coefficients value as required (this step is optional)
 - d. Enable all desired input channels by writing to P0_R115
 - e. Enable all desired audio serial interface output channels by writing to P0_R116
 - f. Power-up the ADC, MICBIAS, and PLL by writing to P0_R117
 - g. Apply FSYNC and BCLK with the desired output sample rates and the BCLK to FSYNC ratio
 This specific step can be done at any point in the sequence after step a.
 See the 节 8.3.2 section for supported sample rates and the BCLK to FSYNC ratio.
 - h. The device recording data are now sent to the host processor via the TDM audio serial data bus
3. Transition from active mode to sleep mode (again) as required in the system for low-power operation:
 - a. Enter sleep mode by writing to P0_R2 to enable sleep mode
 - b. Wait at least 6 ms (when FSYNC = 48 kHz) for the volume to ramp down and for all blocks to power down
 - c. Read P0_R119 to check the device shutdown and sleep mode status
 - d. If the device P0_R119_D7 status bit is 1'b1 then stop FSYNC and BCLK in the system
 - e. The device now goes into sleep mode (low-power mode < 10 μ A) and retains all register values
4. Transition from sleep mode to active mode (again) as required for the recording operation:
 - a. Wake up the device by writing to P0_R2 to disable sleep mode
 - b. Wait for at least 1 ms to allow the device to complete the internal wake-up sequence
 - c. Apply FSYNC and BCLK with the desired output sample rates and the BCLK to FSYNC ratio
 - d. The device recording data are now sent to the host processor via the TDM audio serial data bus
5. Repeat step 2 to step 4 as required for configuration changes or step 3 to step 4 for mode transitions

9.2.1.2.1 Example Device Register Configuration Script for EVM Setup

This section provides a typical EVM I²C register control script that shows how to set up the PCM6120-Q1 in a two-channel analog microphone recording mode with differential inputs.

```
# Key: w 9C XX YY ==> write to I2C address 0x9C, to register 0xXX, data 0xYY
#           # ==> comment delimiter
#
# The following list gives an example sequence of items that must be executed in the time
# between powering the device up and reading data from the device. There are
# other valid sequences depending on which features are used.
#
# See the PCM6120-Q1EVM user guide for jumper settings and audio connections.
#
# Differential 2-channel : INP1/INM1 - Ch1, INP2/INM2 - Ch2
# FSYNC = 44.1 kHz (output data sample rate), BCLK = 11.2896 MHz (BCLK/FSYNC = 256)
#####
#
# Power-up the IOVDD and AVDD power supplies
# Wait for the IOVDD and AVDD power supplies to settle to a steady-state operating voltage range.
# Wait for 1 ms.
#
# Wake-up the device with an I2C write into P0_R2 using an internal AREG
w 9C 02 81
#
# Enable input Ch-1 and Ch-2 by an I2C write into P0_R115
w 9C 73 C0
#
# Enable ASI output Ch-1 and Ch-2 slots by an I2C write into P0_R116
w 9C 74 C0
#
# Power-up the ADC, MICBIAS, and PLL by an I2C write into P0_R117
w 9C 75 E0
#
# Apply FSYNC = 44.1 kHz and BCLK = 11.2896 MHz and
# Start recording data via the host on the ASI bus with a TDM protocol 32-bits channel wordlength
```

9.2.1.3 Application Curves

Measurements are done on the EVM by feeding the device analog input signal using audio precision.

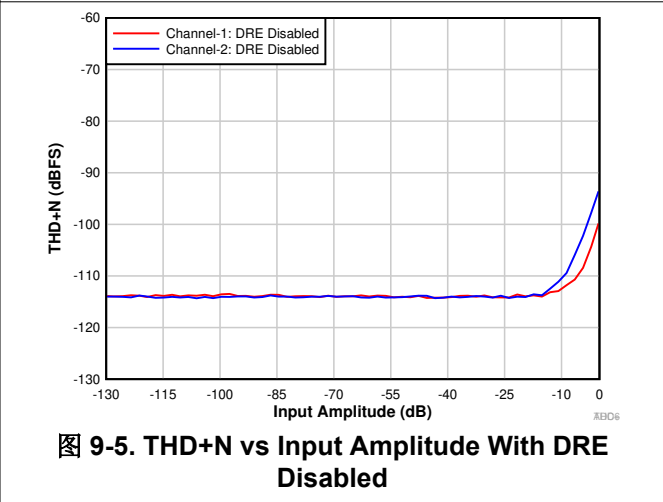
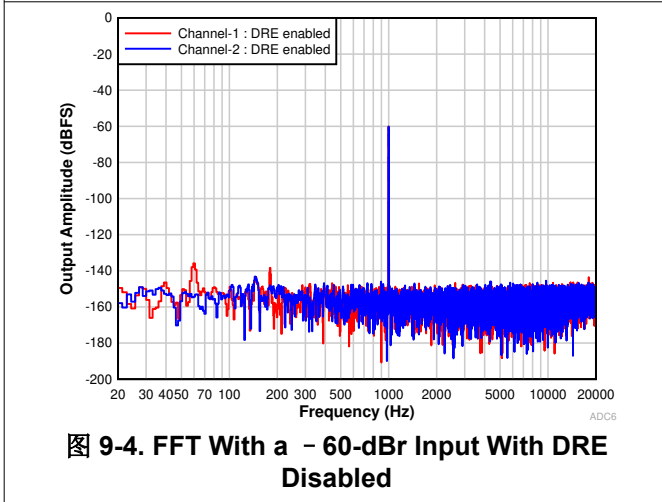
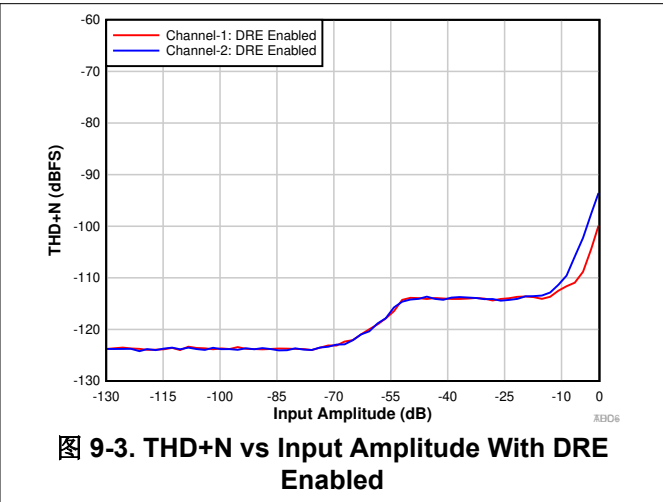
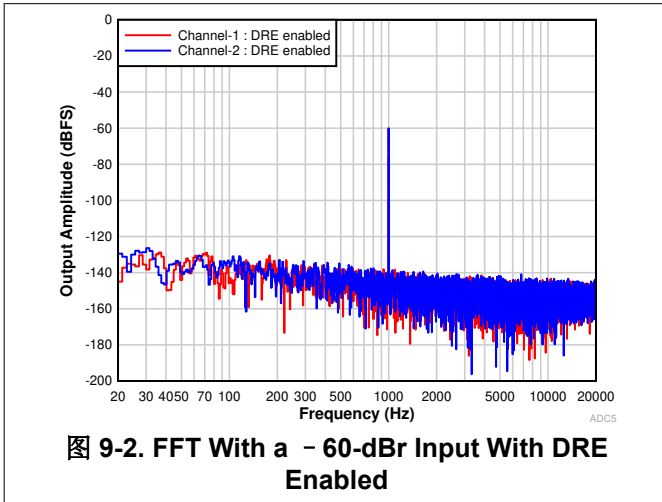

9.2.2 Four-Channel Digital PDM Microphone Recording

图 9-6 shows a typical configuration of the PCM6120-Q1 for an application using four digital PDM MEMS microphones with simultaneous recording operation using an I²C control interface and the TDM audio data slave interface. If the MICBIAS output is not used in the system then the 1 μF capacitor for the MICBIAS pin is not must.



图 9-6. Four-Channel Digital PDM Microphone Recording Diagram

9.2.2.1 Design Requirements

表 9-2 lists the design parameters for this application.

表 9-2. Design Parameters

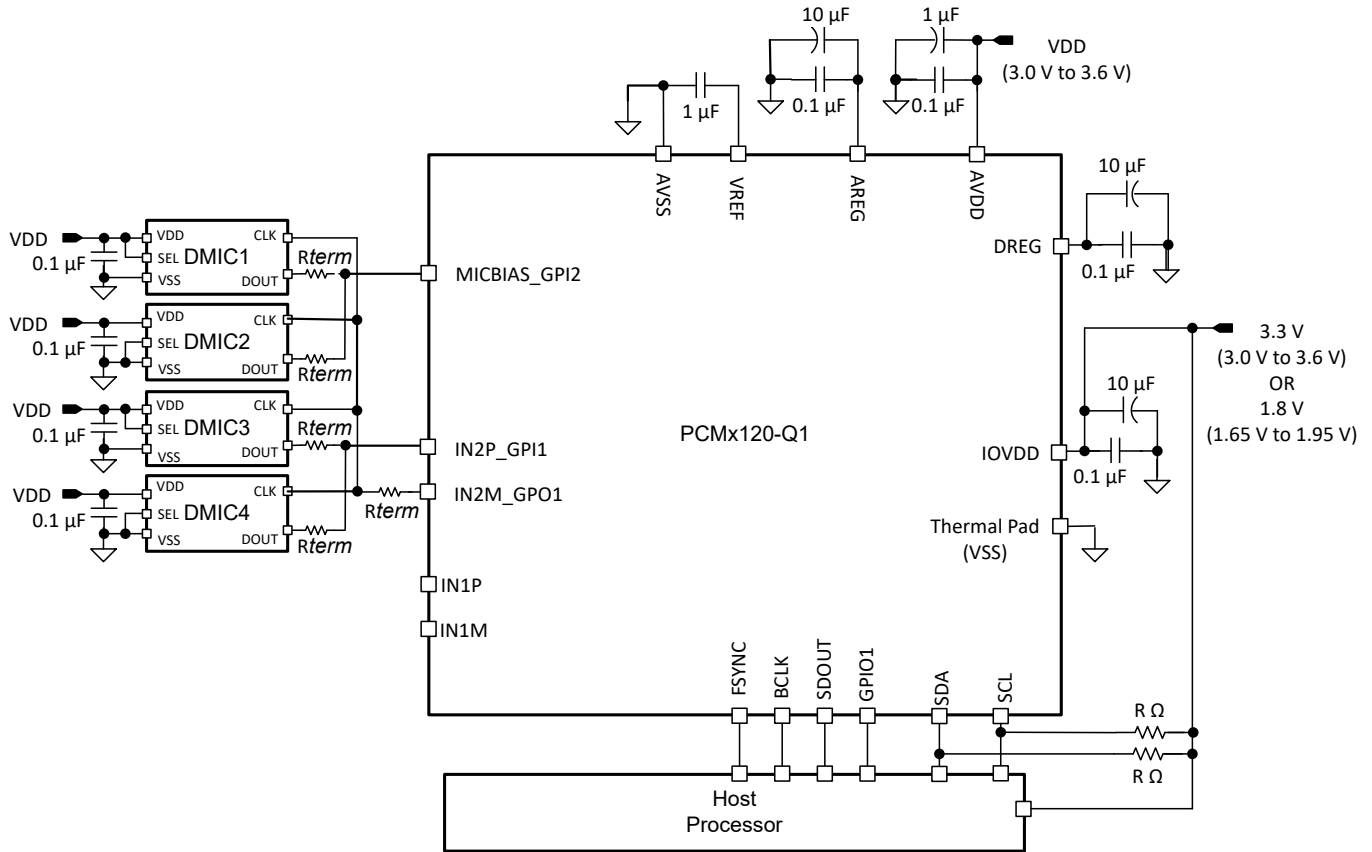
KEY PARAMETER	SPECIFICATION
AVDD	3.3 V
AVDD supply current consumption	>8 mA (PLL on, four-channel recording, f _s = 48 kHz)
IOVDD	1.8 V or 3.3 V

9.2.2.2 Detailed Design Procedure

This section describes the necessary steps to configure the PCM6120-Q1 for this specific application. The following steps provide a sequence of items that must be executed in the time between powering the device up and reading data from the device or transitioning from one mode to another mode of operation.

1. Apply power to the device:
 - a. Power up the IOVDD and AVDD power supplies
 - b. Wait for at least 1 ms to allow the device to initialize the internal registers initialization
 - c. The device now goes into sleep mode (low-power mode < 10 μ A)
2. Transition from sleep mode to active mode whenever required for the recording operation:
 - a. Wake up the device by writing to P0_R2 to disable sleep mode
 - b. Wait for at least 1 ms to allow the device to complete the internal wake-up sequence
 - c. Override the default configuration registers or programmable coefficients value as required (this step is optional)
 - d. Configure channel 1 to channel 2 (CHx_INSRC) for the digital microphone as the input source for recording
 - e. Configure GPO1 (GPO1_CFG) and GPIO1 (GPIO1_CFG) as the PDMCLK output
 - f. Configure GPIx (GPI1x_CFG) as PDMDINx
 - g. Enable all desired input channels by writing to P0_R115
 - h. Enable all desired audio serial interface output channels by writing to P0_R116
 - i. Power-up the ADC and PLL by writing to P0_R117
 - j. Apply FSYNC and BCLK with the desired output sample rates and the BCLK to FSYNC ratio

This specific step can be done at any point in the sequence after step a.

See the [§ 8.3.2](#) section for supported sample rates and the BCLK to FSYNC ratio.

- k. The device recording data is now sent to the host processor using the TDM audio serial data bus
3. Transition from active mode to sleep mode (again) as required in the system for low-power operation:
 - a. Enter sleep mode by writing to P0_R2 to enable sleep mode
 - b. Wait at least 6 ms (when FSYNC = 48 kHz) for the volume to ramp down and for all blocks to power down
 - c. Read P0_R119 to check the device shutdown and sleep mode status
 - d. If the device P0_R119_D7 status bit is 1'b1 then stop FSYNC and BCLK in the system
 - e. The device now goes into sleep mode (low-power mode < 10 μ A) and retains all register values
4. Transition from sleep mode to active mode (again) as required for the recording operation:
 - a. Wake up the device by writing to P0_R2 to disable sleep mode
 - b. Wait at least 1 ms to allow the device to complete the internal wake-up sequence
 - c. Apply FSYNC and BCLK with the desired output sample rates and the BCLK to FSYNC ratio
 - d. The device recording data are now sent to the host processor using the TDM audio serial data bus
5. Repeat step 3 and step 4 as required for mode transitions and step 2 to step 4 for configuration changes

9.2.2.2.1 Example Device Register Configuration Script for EVM Setup

This section provides a typical EVM I²C register control script that shows how to set up the PCM6120-Q1 in a four-channel digital PDM microphone recording mode.

```
# Key: w 9C XX YY ==> write to I2C address 0x9C, to register 0xXX, data 0xYY
#           # ==> comment delimiter
#
# The following list gives an example sequence of items that must be executed in the time
# between powering the device up and reading data from the device. There are
# other valid sequences depending on which features are used.
#
# See the PCM6120-Q1EVM user guide for jumper settings and audio connections.
#
# PDM 4-channel : PDMDIN1 - Ch1 and Ch2, PDMDIN2 - Ch3 and Ch4
#
# FSYNC = 44.1 kHz (output data sample rate), BCLK = 11.2896 MHz (BCLK/FSYNC = 256)
#####
#
# Power-up the IOVDD and AVDD power supplies
# Wait for the IOVDD and AVDD power supplies to settle to a steady state operating voltage range.
# Wait for 1 ms.
#
# Wake-up the device by an I2C write into P0_R2 using an internal AREG
w 9C 02 81
#
# Configure CH2_INSRC as a digital PDM input by an I2C write into P0_R65
w 9C 41 40
#
# Configure MICBIAS_GPI2 as a digital PDM input by an I2C write into P0_R59
w 9C 3B 70
#
# Configure GPO1 as PDMCLK by an I2C write into P0_R34
w 9C 22 41
#
# Configure GPI1 and GPI2 as PDMDIN1 and PDMDIN2 by an I2C write into P0_R43
w 9C 2B 45
#
# Enable input Ch-1 to Ch-4 by an I2C write into P0_R115
w 9C 73 F0
#
# Enable ASI output Ch-1 to Ch-4 slots by an I2C write into P0_R116
w 9C 74 F0
#
# Power-up the ADC and PLL by an I2C write into P0_R117
w 9C 75 60
#
# Apply FSYNC = 44.1 kHz and BCLK = 11.2896 MHz and
# Start recording data via the host on the ASI bus with a TDM protocol 32-bits channel wordlength
```

9.3 What to Do and What Not to Do

In the VAD mode of operation, there are some limitations on interrupt generation when auto wake up is enabled. For details about these limitations, see the [Using the Voice Activity Detector \(VAD\) in the TLV320ADC5120 and TLV320ADC6120 application report](#).

The automatic gain controller (AGC) feature has some limitation when using sampling rates lower than 44.1 kHz. For further details about this limitation, see the [Using the Automatic Gain Controller \(AGC\) in TLV320ADCx120 Family application report](#).

10 Power Supply Recommendations

The power-supply sequence between the IOVDD and AVDD rails can be applied in any order. However, after all supplies are stable, then only initiate the I²C transactions to initialize the device.

For the supply power-up requirement, t_1 and t_2 must be at least 2 ms to allow the device to initialize the internal registers. See the [§ 8.4](#) section for details on how the device operates in various modes after the device power supplies are settled to the recommended operating voltage levels. For the supply power-down requirement, t_3 and t_4 must be at least 10 ms. This timing (as shown in [Figure 10-1](#)) allows the device to ramp down the volume on the record data, power down the analog and digital blocks, and put the device into shutdown mode. The device can also be immediately put into shutdown mode by ramping down power supplies, but doing so causes an abrupt shutdown.

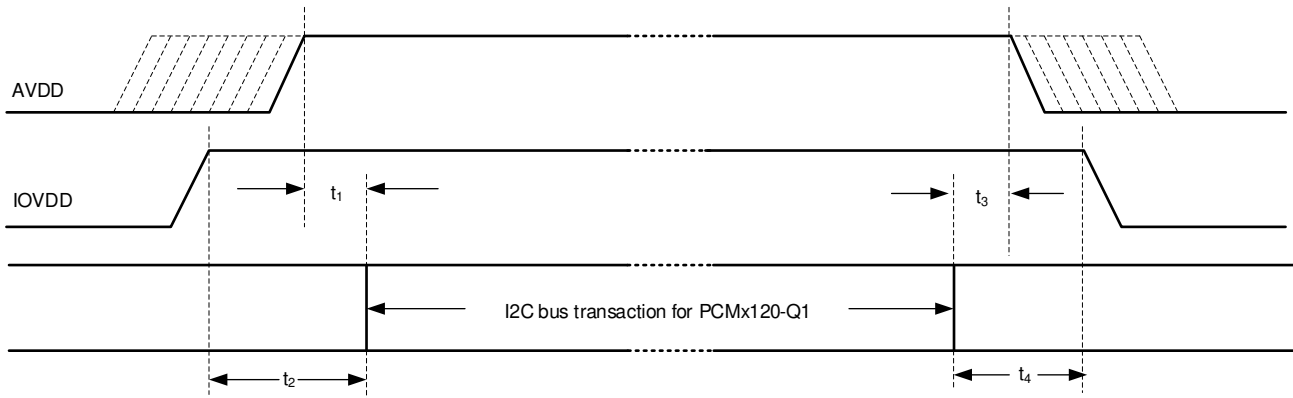

Make sure that the supply ramp rate is slower than 1 V/ μ s and that the wait time between a power-down and a power-up event is at least 100 ms. For supply ramp rate slower than 0.1 V/ms, host device must apply a software reset as first transaction before doing any device configuration. Make sure all digital input pins are at valid input levels and not toggling during supply sequencing.

The PCM6120-Q1 supports a single AVDD supply operation by integrating an on-chip digital regulator, DREG, and an analog regulator, AREG. However, if the AVDD voltage is less than 1.98 V in the system, then short the AREG and AVDD pins onboard and do not enable the internal AREG by keeping the AREG_SELECT bit to 1b'0 (default value) of P0_R2. If the AVDD supply used in the system is higher than 2.7 V, then the host device can set AREG_SELECT to 1'b1 while exiting sleep mode to allow the device internal regulator to generate the AREG supply.

11 Layout

11.1 Layout Guidelines

Each system design and printed circuit board (PCB) layout is unique. The layout must be carefully reviewed in the context of a specific PCB design. However, the following guidelines can optimize the device performance:

- Connect the thermal pad to ground. Use a via pattern to connect the device thermal pad, which is the area directly under the device, to the ground planes. This connection helps dissipate heat from the device.
- The decoupling capacitors for the power supplies must be placed close to the device pins.
- The supply decoupling capacitors must be used ceramic type with low ESR.
- Route the analog differential audio signals differentially on the PCB for better noise immunity. Avoid crossing digital and analog signals to prevent undesirable crosstalk.
- The device internal voltage references must be filtered using external capacitors. Place the filter capacitors near the VREF pin for optimal performance.
- Directly tap the MICBIAS pin to avoid common impedance when routing the biasing or supply traces for multiple microphones to avoid coupling across microphones.
- Directly short the VREF and MICBIAS external capacitors ground terminal to the AVSS pin without using any vias for this connection trace.
- Place the MICBIAS capacitor (with low equivalent series resistance) close to the device with minimal trace impedance.
- Use ground planes to provide the lowest impedance for power and signal current between the device and the decoupling capacitors. Treat the area directly under the device as a central ground area for the device, and all device grounds must be connected directly to that area.

11.2 Layout Example



图 11-1. Layout Example

12 Device and Documentation Support

12.1 Documentation Support

12.1.1 Related Documentation

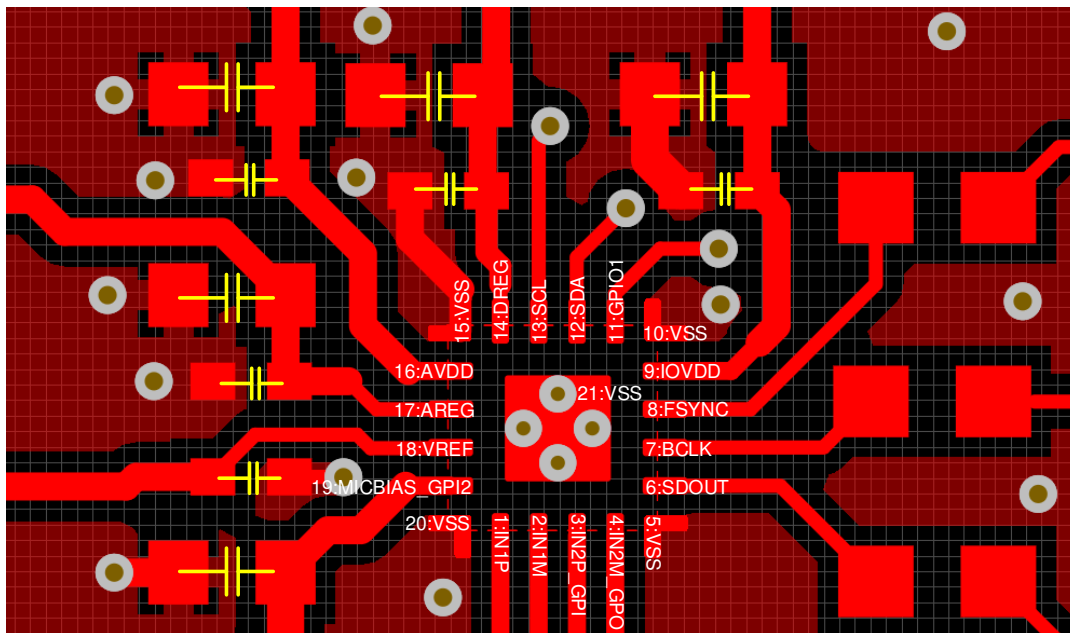
For related documentation see the following:

- Texas Instruments, [Multiple TLV320ADCx140 & TLV320ADCx120 Multiple TLV320ADCx140 Devices With Shared TDM and I²C Bus application report](#)
- Texas Instruments, [Configuring and Operating TLV320ADCx120 as an Audio Bus Master application report](#)
- Texas Instruments, [TLV320ADCx120 Sampling Rates and Programmable Processing Blocks Supported application report](#)
- Texas Instruments, [TLV320ADCx140 & TLV320ADCx120 Programmable Biquad Filter Configuration and Applications application report](#)
- Texas Instruments, [TLV320ADCx120 Power Consumption Matrix Across Various Usage Scenarios application report](#)
- Texas Instruments, [TLV320ADCx140 & TLV320ADCx120 Integrated Analog Anti-Aliasing Filter and Flexible Digital Filter application report](#)
- Texas Instruments, [Using the Automatic Gain Controller \(AGC\) in TLV320ADCx120 Family application report](#)
- Texas Instruments, [Using the Voice Activity Detector \(VAD\) in the TLV320ADCx120 and PCMD3140 devices application report](#)
- Texas Instruments, [Input Common Mode Tolerance and High CMRR modes for TLV320ADCx120 devices application report](#)
- Texas Instruments, [Using the Dynamic Range Enhancer \(DRE\) and Dynamic Range Compressor \(DRC\) in TLV320ADC5120/6120 application report](#)
- Texas Instruments, [ADCx120EVM-PDK Evaluation module user's guide](#)
- Texas Instruments, [PurePath™ Console Graphical Development Suite for Audio System Design and Development](#)

12.2 接收文档更新通知

要接收文档更新通知，请导航至 ti.com 上的器件产品文件夹。点击 [订阅更新](#) 进行注册，即可每周接收产品信息更改摘要。有关更改的详细信息，请查看任何已修订文档中包含的修订历史记录。

12.3 支持资源

[TI E2E™ 支持论坛](#) 是工程师的重要参考资料，可直接从专家获得快速、经过验证的解答和设计帮助。搜索现有解答或提出自己的问题可获得所需的快速设计帮助。

链接的内容由各个贡献者“按原样”提供。这些内容并不构成 TI 技术规范，并且不一定反映 TI 的观点；请参阅 TI 的《[使用条款](#)》。

12.4 Trademarks

Burr-Brown™, PurePath™, and TI E2E™ are trademarks of Texas Instruments.

所有商标均为其各自所有者的财产。

12.5 Electrostatic Discharge Caution



This integrated circuit can be damaged by ESD. Texas Instruments recommends that all integrated circuits be handled with appropriate precautions. Failure to observe proper handling and installation procedures can cause damage.

ESD damage can range from subtle performance degradation to complete device failure. Precision integrated circuits may be more susceptible to damage because very small parametric changes could cause the device not to meet its published specifications.

12.6 术语表

TI 术语表

本术语表列出并解释了术语、首字母缩略词和定义。

13 Mechanical, Packaging, and Orderable Information

The following pages include mechanical, packaging, and orderable information. This information is the most current data available for the designated devices. This data is subject to change without notice and revision of this document. For browser-based versions of this data sheet, refer to the left-hand navigation.

RTE0020A

PACKAGE OUTLINE
WQFN - 0.8 mm max height

PLASTIC QUAD FLATPACK- NO LEAD

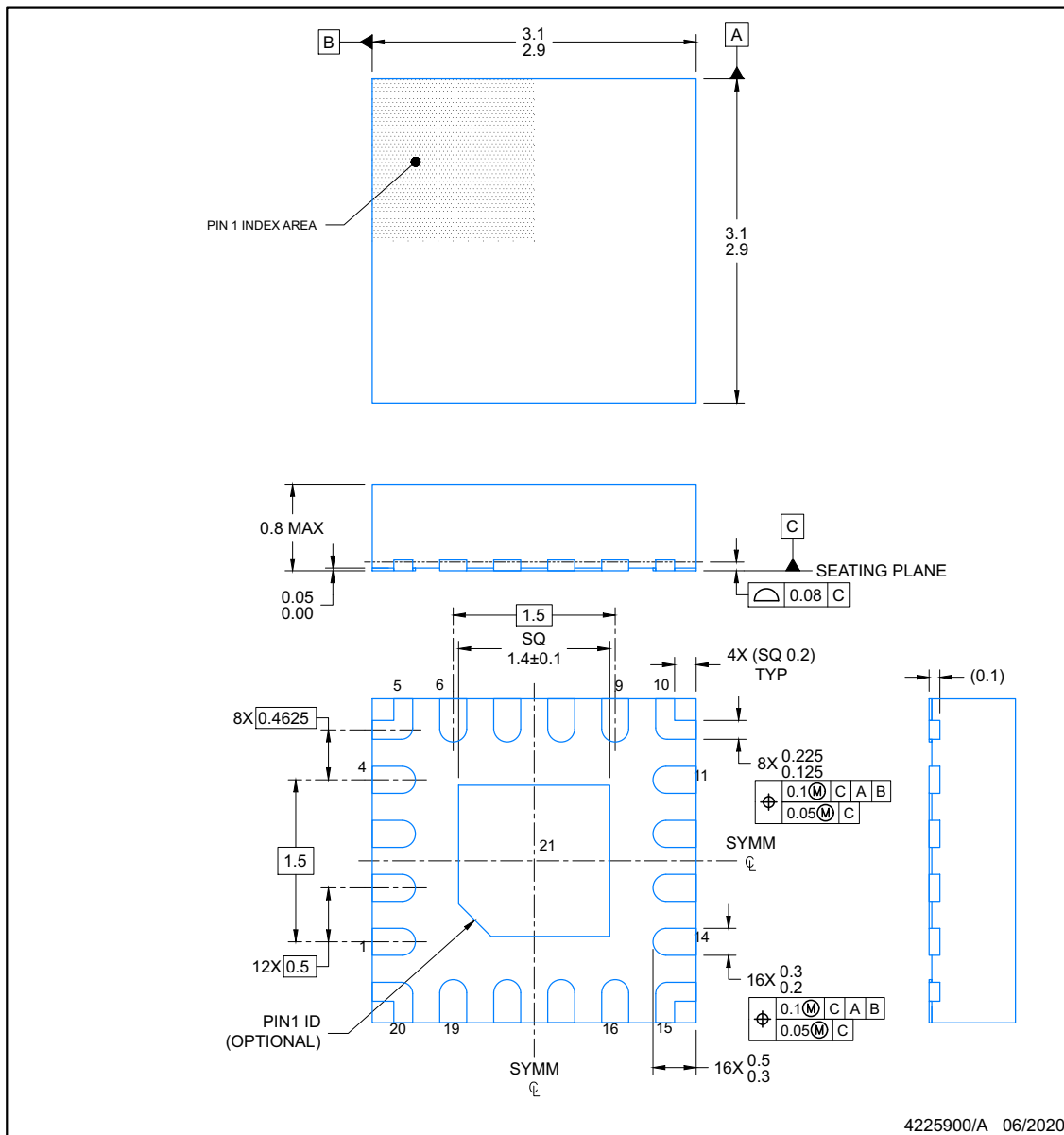

4225900/A 06/2020

NOTES:

1. All linear dimensions are in millimeters. Any dimensions in parenthesis are for reference only. Dimensioning and tolerancing per ASME Y14.5M.
2. This drawing is subject to change without notice.
3. The package thermal pad must be soldered to the printed circuit board for optimal thermal and mechanical performance.

EXAMPLE BOARD LAYOUT
WQFN - 0.8 mm max height

RTE0020A

PLASTIC QUAD FLATPACK- NO LEAD

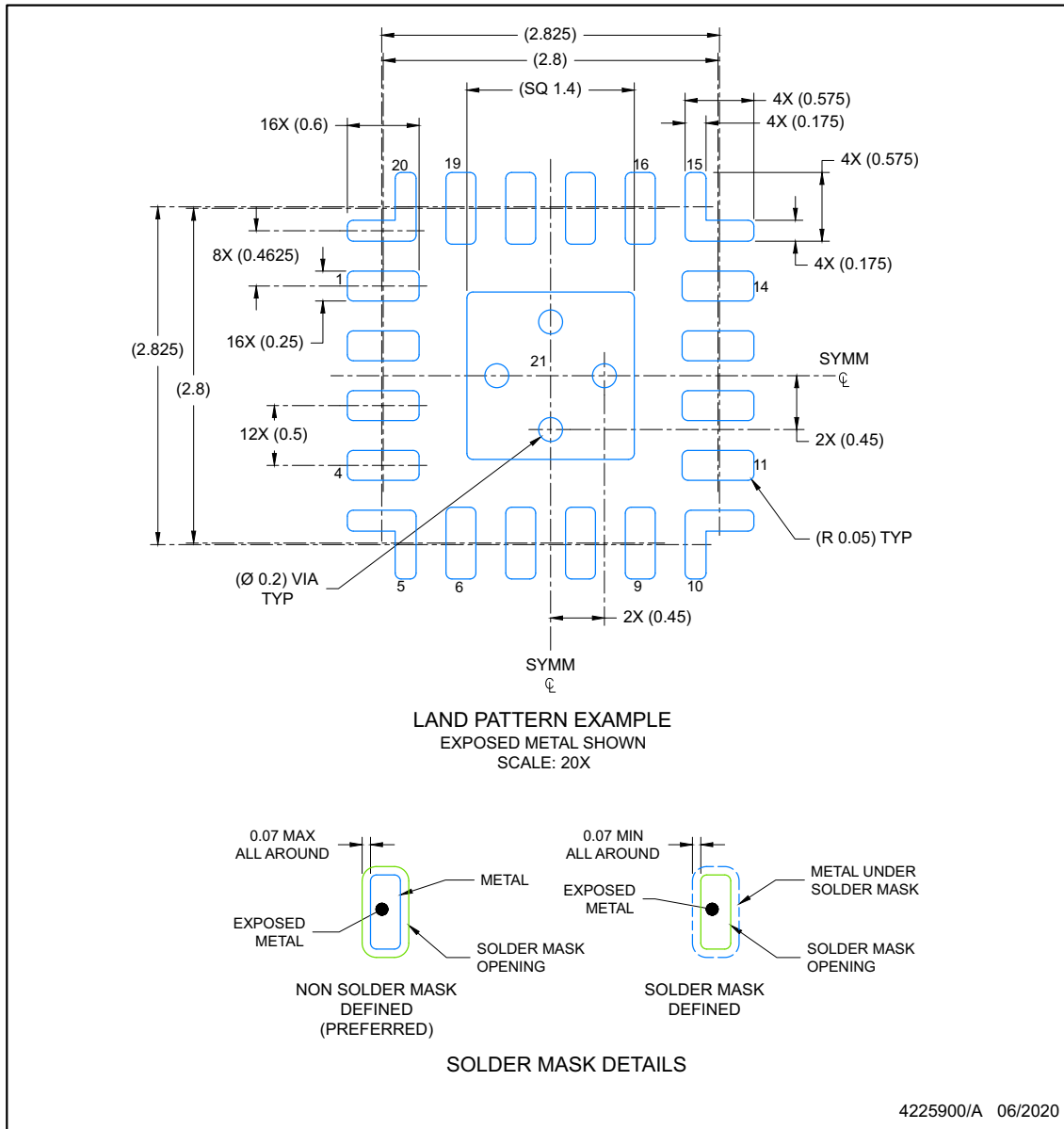

NOTES: (continued)

4. This package is designed to be soldered to a thermal pad on the board. For more information, see Texas Instruments literature number SLUA271 (www.ti.com/lit/sl原因271).
5. Vias are optional depending on application, refer to device data sheet. If any vias are implemented, refer to their locations shown on this view. It is recommended that vias under paste be filled, plugged or tented.

EXAMPLE STENCIL DESIGN

RTE0020A

WQFN - 0.8 mm max height

PLASTIC QUAD FLATPACK- NO LEAD

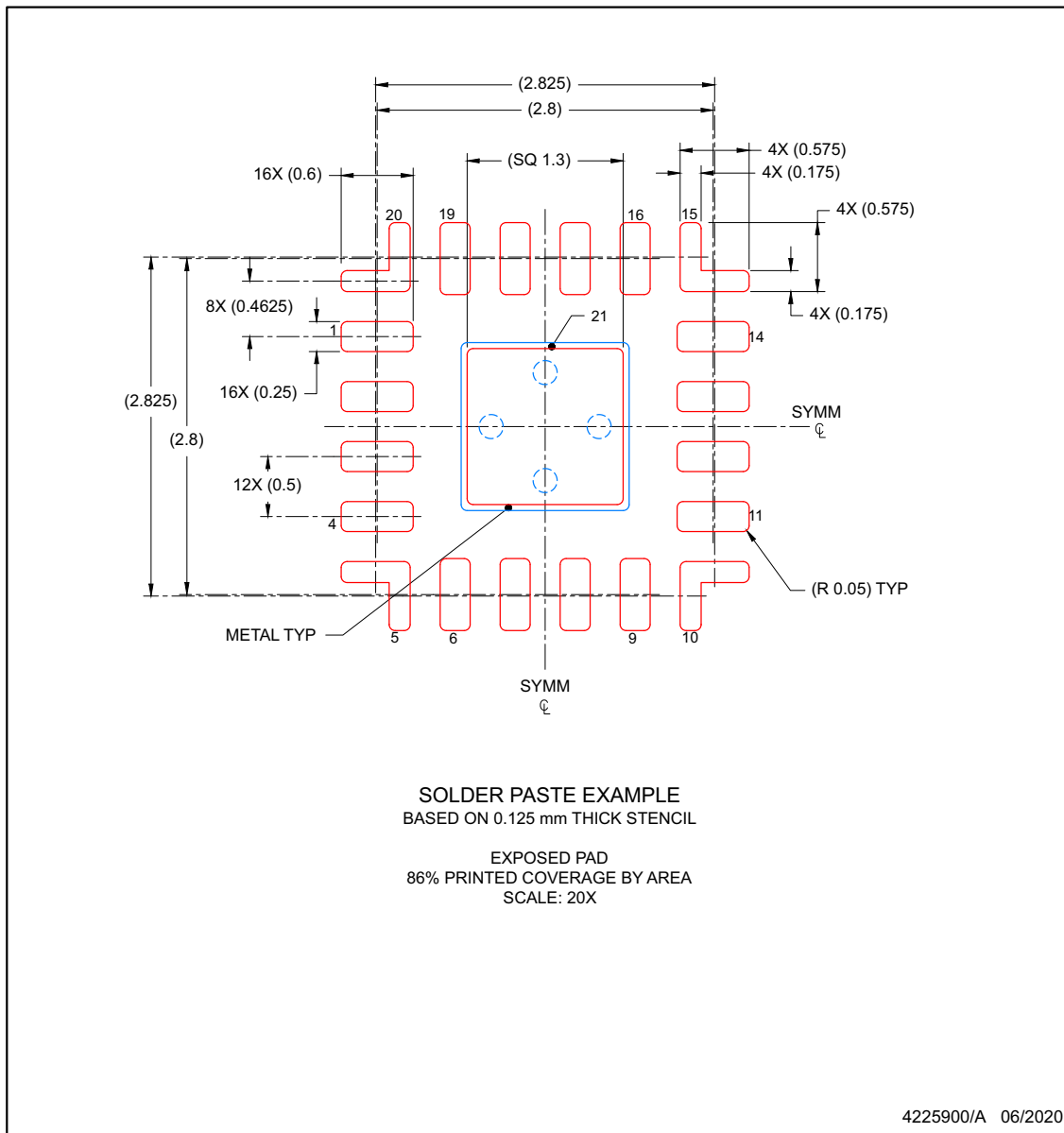

NOTES: (continued)

6. Laser cutting apertures with trapezoidal walls and rounded corners may offer better paste release. IPC-7525 may have alternate design recommendations.

13.1 Tape and Reel Information

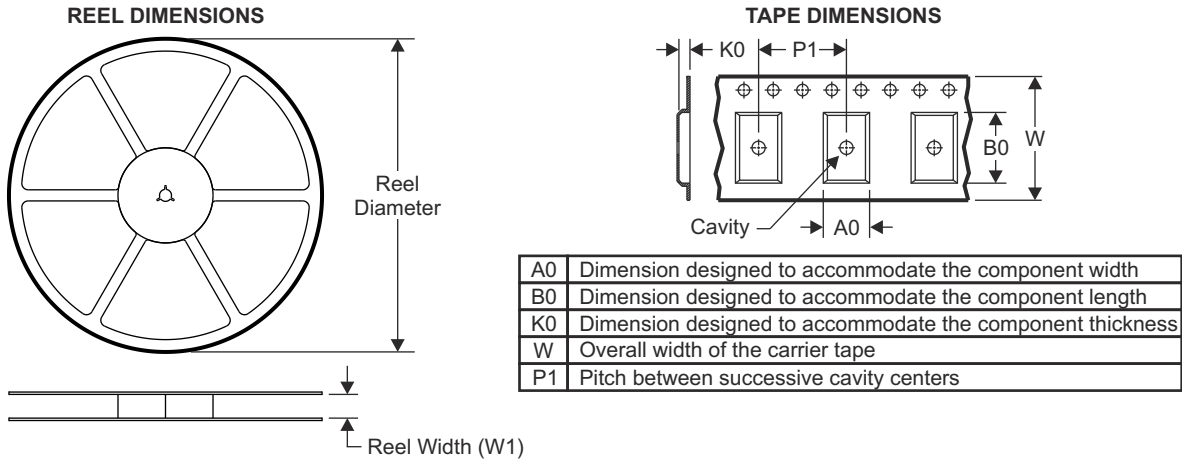

QUADRANT ASSIGNMENTS FOR PIN 1 ORIENTATION IN TAPE

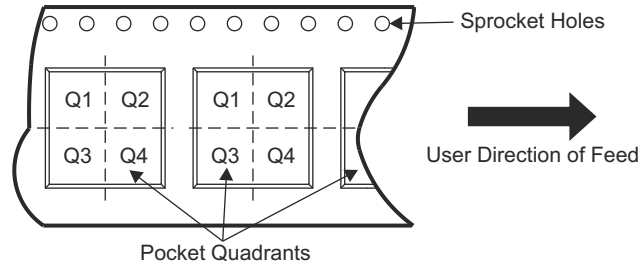

Device	Package Type	Package Drawing	Pins	SPQ	Reel Diameter (mm)	Reel Width W1 (mm)	A0 (mm)	B0 (mm)	K0 (mm)	P1 (mm)	W (mm)	Pin1 Quadrant
XCM6120QRTERQ1	WQFN	RTE	20	3000	330	12.4	3.3	3.3	1.1	8	12	Q2

TAPE AND REEL BOX DIMENSIONS

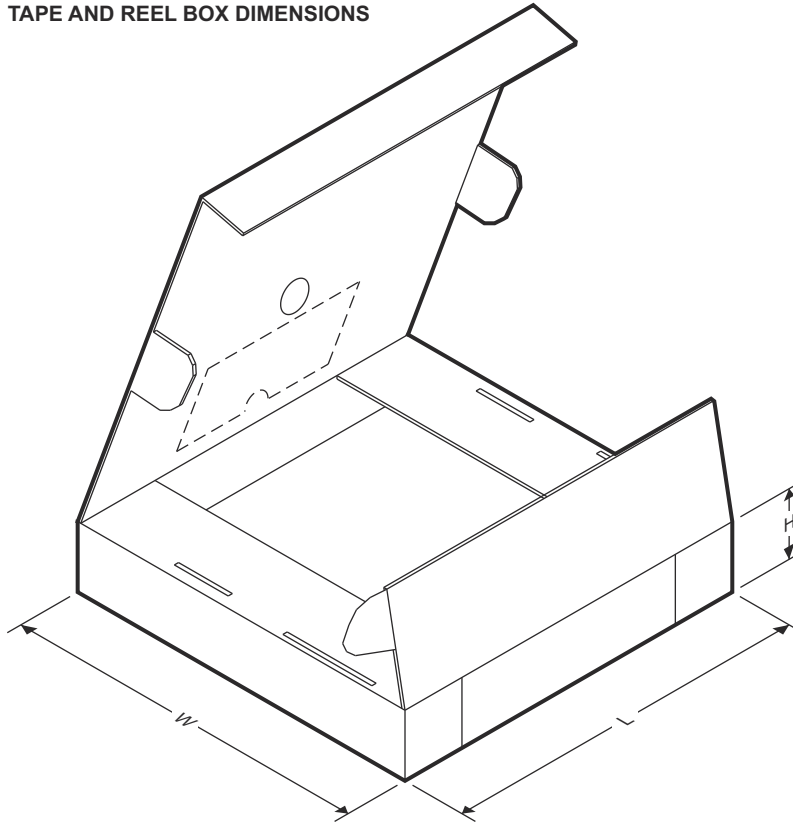

Device	Package Type	Package Drawing	Pins	SPQ	Length (mm)	Width (mm)	Height (mm)
XCM6120QRTERQ1	WQFN	RTE	20	3000	367	367	35

PACKAGING INFORMATION

Orderable Device	Status (1)	Package Type	Package Drawing	Pins	Package Qty	Eco Plan (2)	Lead finish/ Ball material (6)	MSL Peak Temp (3)	Op Temp (°C)	Device Marking (4/5)	Samples
PCM6120QRTERQ1	ACTIVE	WQFN	RTE	20	3000	RoHS & Green	NIPDAU	Level-2-260C-1 YEAR	-40 to 125	6120Q	Samples

(1) The marketing status values are defined as follows:

ACTIVE: Product device recommended for new designs.

LIFEBUY: TI has announced that the device will be discontinued, and a lifetime-buy period is in effect.

NRND: Not recommended for new designs. Device is in production to support existing customers, but TI does not recommend using this part in a new design.

PREVIEW: Device has been announced but is not in production. Samples may or may not be available.

OBSELETE: TI has discontinued the production of the device.

(2) **RoHS:** TI defines "RoHS" to mean semiconductor products that are compliant with the current EU RoHS requirements for all 10 RoHS substances, including the requirement that RoHS substance do not exceed 0.1% by weight in homogeneous materials. Where designed to be soldered at high temperatures, "RoHS" products are suitable for use in specified lead-free processes. TI may reference these types of products as "Pb-Free".

RoHS Exempt: TI defines "RoHS Exempt" to mean products that contain lead but are compliant with EU RoHS pursuant to a specific EU RoHS exemption.

Green: TI defines "Green" to mean the content of Chlorine (Cl) and Bromine (Br) based flame retardants meet JS709B low halogen requirements of <=1000ppm threshold. Antimony trioxide based flame retardants must also meet the <=1000ppm threshold requirement.

(3) MSL, Peak Temp. - The Moisture Sensitivity Level rating according to the JEDEC industry standard classifications, and peak solder temperature.

(4) There may be additional marking, which relates to the logo, the lot trace code information, or the environmental category on the device.

(5) Multiple Device Markings will be inside parentheses. Only one Device Marking contained in parentheses and separated by a "-" will appear on a device. If a line is indented then it is a continuation of the previous line and the two combined represent the entire Device Marking for that device.

(6) Lead finish/Ball material - Orderable Devices may have multiple material finish options. Finish options are separated by a vertical ruled line. Lead finish/Ball material values may wrap to two lines if the finish value exceeds the maximum column width.

Important Information and Disclaimer:The information provided on this page represents TI's knowledge and belief as of the date that it is provided. TI bases its knowledge and belief on information provided by third parties, and makes no representation or warranty as to the accuracy of such information. Efforts are underway to better integrate information from third parties. TI has taken and continues to take reasonable steps to provide representative and accurate information but may not have conducted destructive testing or chemical analysis on incoming materials and chemicals. TI and TI suppliers consider certain information to be proprietary, and thus CAS numbers and other limited information may not be available for release.

In no event shall TI's liability arising out of such information exceed the total purchase price of the TI part(s) at issue in this document sold by TI to Customer on an annual basis.

TAPE AND REEL INFORMATION

QUADRANT ASSIGNMENTS FOR PIN 1 ORIENTATION IN TAPE



*All dimensions are nominal

Device	Package Type	Package Drawing	Pins	SPQ	Reel Diameter (mm)	Reel Width W1 (mm)	A0 (mm)	B0 (mm)	K0 (mm)	P1 (mm)	W (mm)	Pin1 Quadrant
PCM6120QRTERQ1	WQFN	RTE	20	3000	330.0	12.4	3.3	3.3	1.1	8.0	12.0	Q2

TAPE AND REEL BOX DIMENSIONS

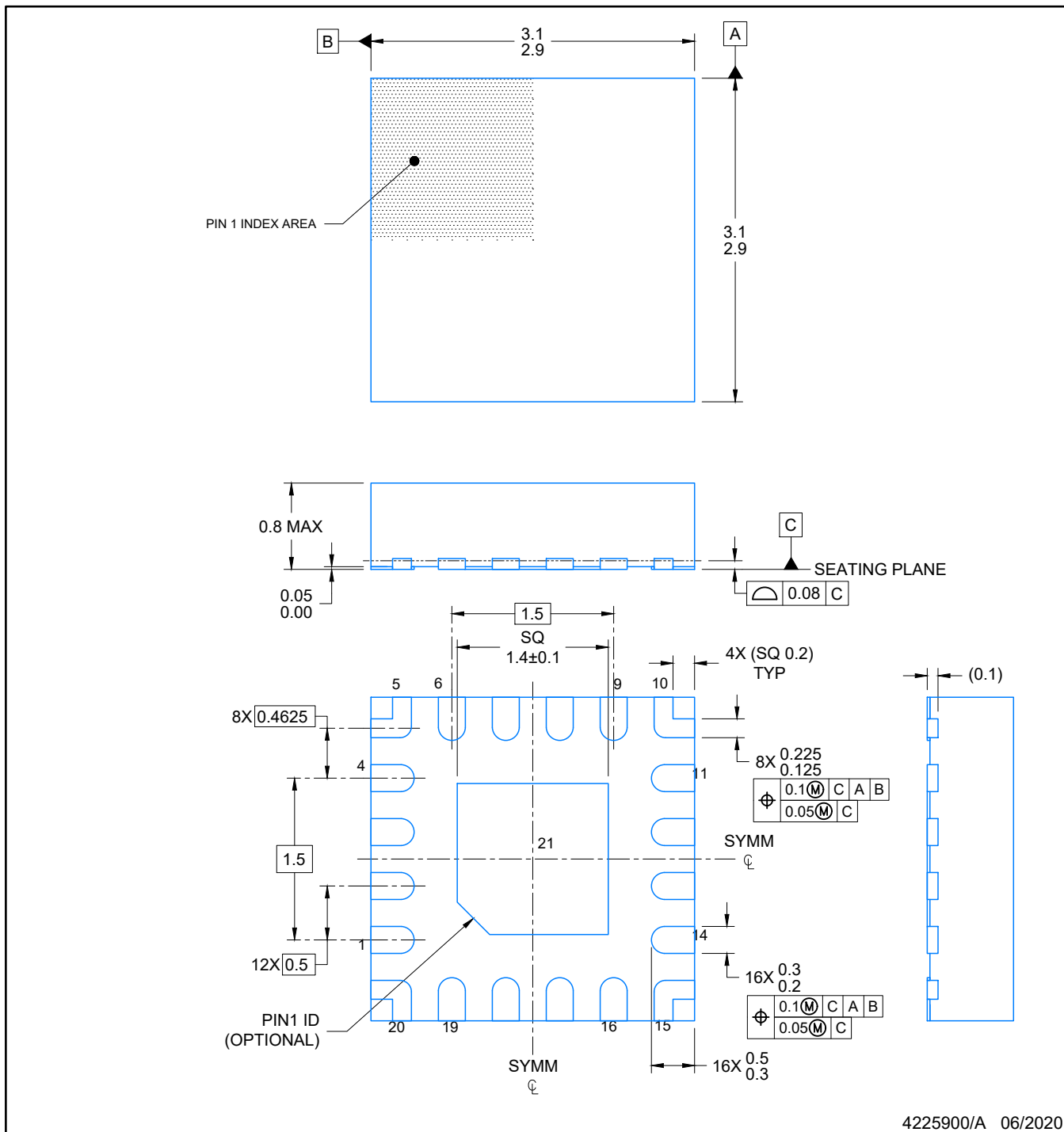

*All dimensions are nominal

Device	Package Type	Package Drawing	Pins	SPQ	Length (mm)	Width (mm)	Height (mm)
PCM6120QRTERQ1	WQFN	RTE	20	3000	367.0	367.0	35.0

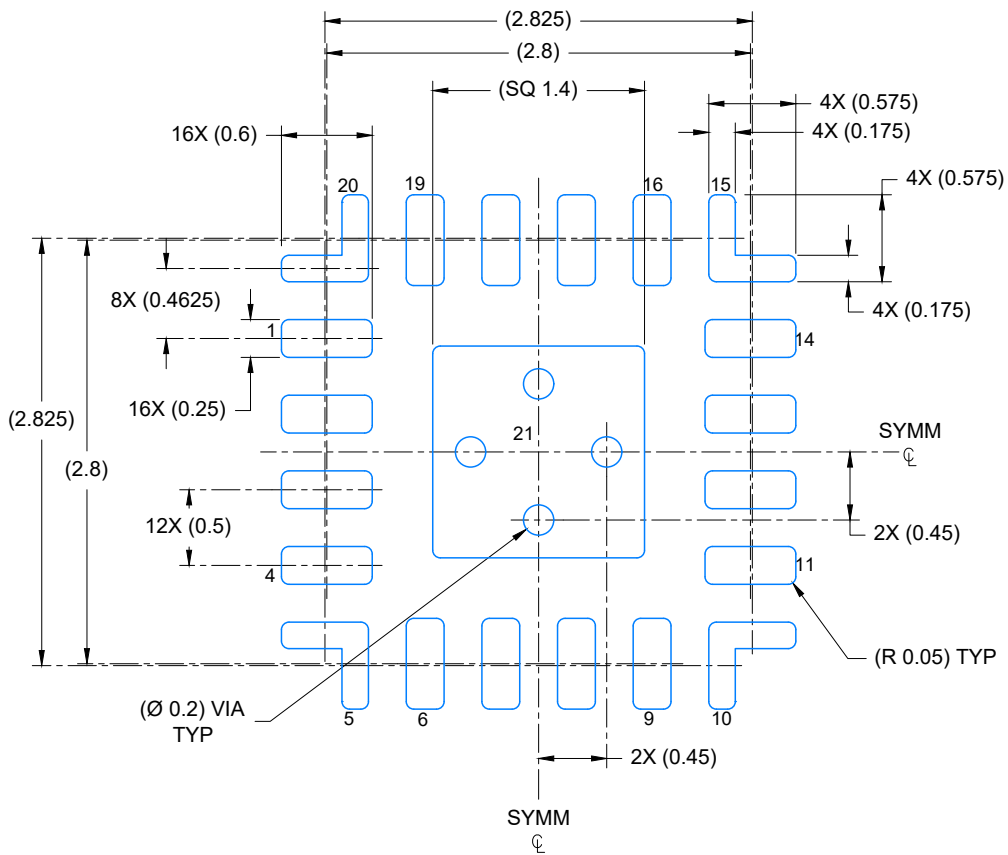

NOTES:

1. All linear dimensions are in millimeters. Any dimensions in parenthesis are for reference only. Dimensioning and tolerancing per ASME Y14.5M.
2. This drawing is subject to change without notice.
3. The package thermal pad must be soldered to the printed circuit board for optimal thermal and mechanical performance.



LAND PATTERN EXAMPLE
EXPOSED METAL SHOWN
SCALE: 20X

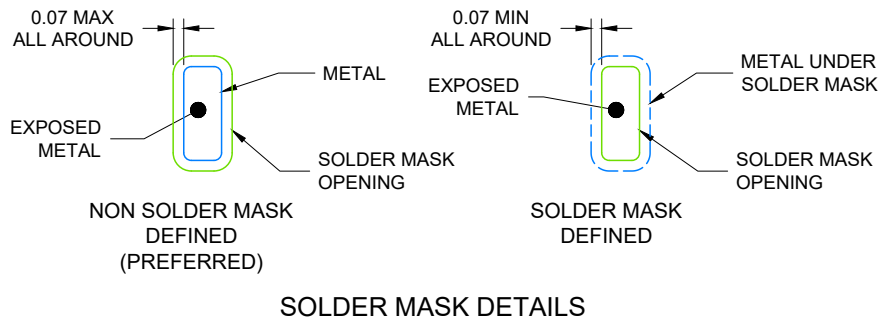

4225900/A 06/2020

NOTES: (continued)

4. This package is designed to be soldered to a thermal pad on the board. For more information, see Texas Instruments literature number SLUA271 (www.ti.com/lit/sluea271).
5. Vias are optional depending on application, refer to device data sheet. If any vias are implemented, refer to their locations shown on this view. It is recommended that vias under paste be filled, plugged or tented.

EXAMPLE STENCIL DESIGN

RTE0020A

WQFN - 0.8 mm max height

PLASTIC QUAD FLATPACK- NO LEAD

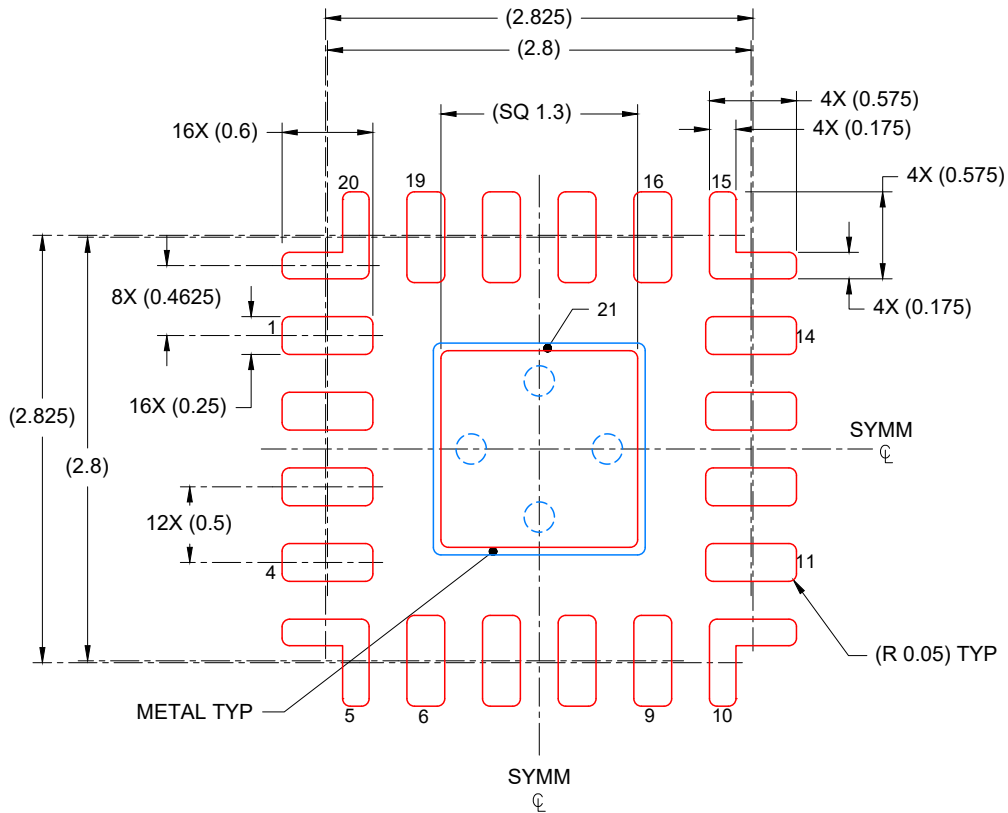

SOLDER PASTE EXAMPLE
BASED ON 0.125 mm THICK STENCIL

EXPOSED PAD
86% PRINTED COVERAGE BY AREA
SCALE: 20X

4225900/A 06/2020

NOTES: (continued)

6. Laser cutting apertures with trapezoidal walls and rounded corners may offer better paste release. IPC-7525 may have alternate design recommendations.

重要声明和免责声明

TI“按原样”提供技术和可靠性数据（包括数据表）、设计资源（包括参考设计）、应用或其他设计建议、网络工具、安全信息和其他资源，不保证没有瑕疵且不做任何明示或暗示的担保，包括但不限于对适销性、某特定用途方面的适用性或不侵犯任何第三方知识产权的暗示担保。

这些资源可供使用 TI 产品进行设计的熟练开发人员使用。您将自行承担以下全部责任：(1) 针对您的应用选择合适的 TI 产品，(2) 设计、验证并测试您的应用，(3) 确保您的应用满足相应标准以及任何其他功能安全、信息安全、监管或其他要求。

这些资源如有变更，恕不另行通知。TI 授权您仅可将这些资源用于研发本资源所述的 TI 产品的应用。严禁对这些资源进行其他复制或展示。您无权使用任何其他 TI 知识产权或任何第三方知识产权。您应全额赔偿因在这些资源的使用中对 TI 及其代表造成的任何索赔、损害、成本、损失和债务，TI 对此概不负责。

TI 提供的产品受 [TI 的销售条款](#) 或 [ti.com](#) 上其他适用条款/TI 产品随附的其他适用条款的约束。TI 提供这些资源并不会扩展或以其他方式更改 TI 针对 TI 产品发布的适用的担保或担保免责声明。

TI 反对并拒绝您可能提出的任何其他或不同的条款。

邮寄地址：Texas Instruments, Post Office Box 655303, Dallas, Texas 75265

Copyright © 2022，德州仪器 (TI) 公司