

TPA2025D1 具有 G 类升压转换器和电池跟踪 AGC 的 2W 恒定输出功率 D 类音频放大器

1 特性

- 内置增强型电池跟踪自动增益控制 (AGC)
 - 限制电池电流消耗
- 3.6V 电源电压、8Ω 负载条件下的功率为 1.9W (1% THD+N)
- 集成自适应升压转换器
 - 可提高低输出功率条件下的效率
- 3.6V 电压下的静态电流低至 2mA
- 具有自动恢复功能的热保护和短路保护
- 20dB 固定增益
- 与 TPA2015D1 性能相当
- 采用 1.53mm × 1.982mm、0.5mm 间距、12 焊球晶圆级芯片 (WCSP) 封装

2 应用范围

- 手机
- 个人数据助理 (PDA)，全球卫星定位系统 (GPS)
- 便携式电子设备和扬声器

3 说明

TPA2025D1 是一款采用电池跟踪自动增益控制 (AGC) 技术的高效 D 类音频功率放大器，其集成有 G 类升压转换器，可提升低输出功率条件下的效率。该器件可为 8Ω 扬声器提供高达 1.9W 的驱动功率 (1% THD+N)。TPA2025D1 的效率典型值为 85%，有助于在播放音频时延长电池使用寿命。

内置的升压转换器用于为 D 类放大器提供 5.75V 的电源电压。相比直接连接电池供电的独立放大器，这款放大器可提供更加响亮的音频输出。电池跟踪 AGC 可调节 D 类增益，从而限制低电池电压条件下的电池电流。

TPA2025D1 具有一个集成低通滤波器，可改善射频 (RF) 抑制性能并减少数模转换器 (DAC) 的带外噪声，从而提高信噪比 (SNR)。

TPA2025D1 采用节省空间的 1.53mm × 1.982mm、0.5mm 间距 DSBGA 封装 (YZG)。

器件信息⁽¹⁾

器件型号	封装	封装尺寸 (标称值)
TPA2025D1	DSBGA (12)	1.53mm x 1.982mm

(1) 如需了解所有可用封装，请见数据表末尾的可订购产品附录。

4 简化应用示意图

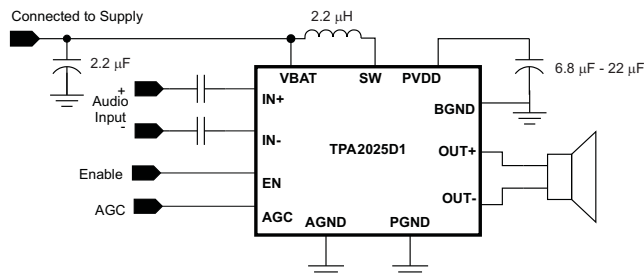

电池跟踪自动增益控制

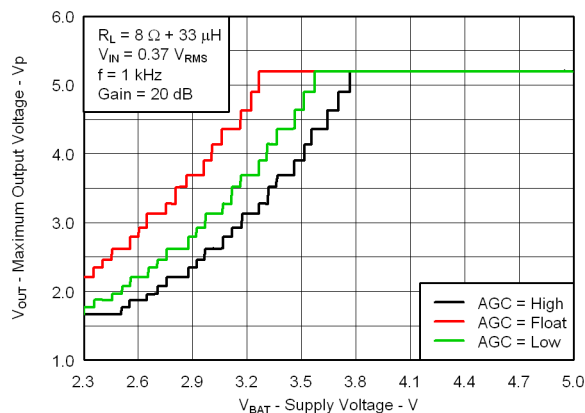

目录

1	特性	1	10.1	Overview	11
2	应用范围	1	10.2	Functional Block Diagram	11
3	说明	1	10.3	Feature Description	12
4	简化应用示意图	1	10.4	Device Functional Modes	13
5	修订历史记录	2	11	Application and Implementation	15
6	Device Comparison Table	3	11.1	Application Information	15
7	Pin Configuration and Functions	3	11.2	Typical Application	15
8	Specifications	4	12	Power Supply Recommendations	20
8.1	Absolute Maximum Ratings	4	12.1	Power Supply Decoupling Capacitors	20
8.2	ESD Ratings	4	13	Layout	20
8.3	Recommended Operating Conditions	4	13.1	Layout Guidelines	20
8.4	Thermal Information	4	13.2	Layout Example	22
8.5	Electrical Characteristics	5	14	器件和文档支持	23
8.6	Operating Characteristics	5	14.1	商标	23
8.7	Typical Characteristics	7	14.2	静电放电警告	23
9	Parameter Measurement Information	11	14.3	术语表	23
10	Detailed Description	11	15	机械、封装和可订购信息	23

5 修订历史记录

NOTE: Page numbers for previous revisions may differ from page numbers in the current version.

Changes from Revision A (February 2012) to Revision B	Page
• 已添加 引脚配置和功能部分, ESD 额定值表, 特性描述部分, 器件功能模式, 应用和实施部分, 电源相关建议部分, 布局部分, 器件和文档支持部分以及机械、封装和可订购信息部分	1

Changes from Original (August 2011) to Revision A	Page
• Changed Operating quiescent current TYP value from "3.5" to "2.0" for VBAT = 3.6 V; and, TYP value from "4" to "2.5" for VBAT = 5.2 V	5
• Changed Shutdown quiescent current MAX value from "3" to "1"	5
• Changed from "110 ms" to "1.6 seconds" in the SHORT CIRCUIT AUTO-RECOVERY description	13
• Changed from "within 200 ms" to "1.6 seconds" in the Speaker Load Limitation description	18

6 Device Comparison Table

DEVICE NAME	DESCRIPTION
TPA2025D1	2 W Constant Output Power Class-D Audio Amplifier with Class-G Boost Converter and Battery Tracking AGC

7 Pin Configuration and Functions

**12-PIN
YZG PACKAGE
(TOP VIEW)**

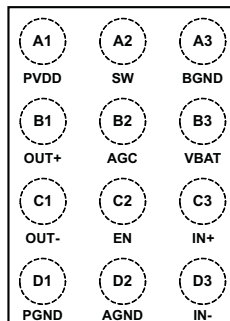

Pin Functions

NAME	PIN		INPUT/ OUTPUT/ POWER (I/O/P)	DESCRIPTION
		WCSP		
PVDD		A1	O	Boost converter output and Class-D power stage supply voltage.
SW		A2	I	Boost converter switch input; connect boost inductor between VBAT and SW.
BGND		A3	P	Boost converter power ground.
OUT+		B1	O	Positive audio output.
AGC		B2	I	AGC inflection point select. Connect to VDD, GND or Float. Voltage at AGC pin is only read at device power-up. A power cycle is required to change inflection points.
VBAT		B3	P	Supply voltage.
OUT-		C1	O	Negative audio output.
EN		C2	I	Device enable; set to logic high to enable.
IN+		C3	I	Positive audio input.
PGND		D1	P	Class-D power ground.
AGND		D2	P	Analog ground.
IN-		D3	I	Negative audio input.

8 Specifications

8.1 Absolute Maximum Ratings

Over operating free-air temperature range, $T_A = 25^\circ\text{C}$ (unless otherwise noted)⁽¹⁾

		MIN	MAX	UNIT
Supply voltage	VBAT	-0.3	6	V
Input Voltage, V_I	IN+, IN-	-0.3	VBAT + 0.3	V
Output continuous total power dissipation		See Thermal Information		
Operating free-air temperature range, T_A		-40	85	$^\circ\text{C}$
Operating junction temperature range, T_J		-40	150	$^\circ\text{C}$
Minimum load resistance		3.2		Ω
Maximum input voltage swing	EN = 0 V		2	V_{RMS}
Storage temperature range, T_{stg}		-65	150	$^\circ\text{C}$

- (1) Stresses beyond those listed under Absolute Maximum Ratings may cause permanent damage to the device. These are stress ratings only, and functional operation of the device at these or any other conditions beyond those indicated under [Recommended Operating Conditions](#) is not implied. Exposure to absolute-maximum-rated conditions for extended periods may affect device reliability.

8.2 ESD Ratings

		VALUE	UNIT
$V_{\text{(ESD)}}$ Electrostatic discharge	Human-body model (HBM), per ANSI/ESDA/JEDEC JS-001 ⁽¹⁾	± 2000	V
	Charged-device model (CDM), per JEDEC specification JESD22-C101 ⁽²⁾	± 500	
	Machine model (MM)	± 100	

- (1) JEDEC document JEP155 states that 500-V HBM allows safe manufacturing with a standard ESD control process.
 (2) JEDEC document JEP157 states that 250-V CDM allows safe manufacturing with a standard ESD control process.

8.3 Recommended Operating Conditions

		MIN	MAX	UNIT
Supply voltage, VBAT		2.5	5.2	V
V_{IH}	High-level input voltage, EN	1.3		V
V_{IL}	Low-level input voltage, EN		0.6	V
T_A	Operating free-air temperature	-40	85	$^\circ\text{C}$
T_J	Operating junction temperature	-40	150	$^\circ\text{C}$

8.4 Thermal Information

THERMAL METRIC ⁽¹⁾		TPA2025D1		UNITS
		YZG		
		12 PINS		
$R_{\theta\text{JA}}$	Junction-to-ambient thermal resistance	97.3		$^\circ\text{C/W}$
$R_{\theta\text{JC(top)}}$	Junction-to-case(top) thermal resistance	36.7		
$R_{\theta\text{JB}}$	Junction-to-board thermal resistance	55.9		
Ψ_{JT}	Junction-to-top characterization parameter	13.9		
Ψ_{JB}	Junction-to-board characterization parameter	49.5		

- (1) For more information about traditional and new thermal metrics, see the *Semiconductor and IC Package Thermal Metrics* application report, [SPRA953](#).

8.5 Electrical Characteristics

V_{BAT} = 3.6 V, T_A = 25°C, R_L = 8 Ω + 33 μH (unless otherwise noted)

PARAMETER	TEST CONDITIONS	MIN	TYP	MAX	UNIT
VBAT supply voltage range		2.5		5.2	V
Class-D supply voltage range	EN = V _{BAT} , boost converter active		5.75		V
	Boost converter disabled (in bypass mode)	2.5		5.2	
Supply under voltage shutdown			2.2		V
Operating quiescent current	EN = V _{BAT} = 3.6 V		2.0	5	mA
	EN = V _{BAT} = 5.2V		2.5	6	
Shutdown quiescent current	V _{BAT} = 2.5 V to 5.2 V, EN = GND		0.2	1	μA
Input common-mode voltage range	IN+, IN–	0.6		1.3	V
Start-up time			6	10	ms

8.6 Operating Characteristics

V_{BAT} = 3.6 V, EN = V_{BAT}, AGC = GND, T_A = 25°C, R_L = 8 Ω + 33 μH (unless otherwise noted)

PARAMETER	TEST CONDITIONS	MIN	TYP	MAX	UNIT	
BOOST CONVERTER						
PVDD	Boost converter output voltage range	I _{BOOST} = 0 mA	5.4	5.75	6.4	V
		I _{BOOST} = 700 mA		5.6		V
I _L	Boost converter input current limit	Power supply current		1800		mA
	Boost converter start-up current limit	Boost converter starts up from full shutdown		600		
		Boost converter wakes up from auto-pass through mode		1000		
f _{BOOST}	Boost converter frequency		1.2		MHz	
CLASS-D AMPLIFIER						
P _O	Output power	THD = 1%, V _{BAT} = 2.5 V, f = 1 kHz		1440		mW
		THD = 1%, V _{BAT} = 3.0 V, f = 1 kHz		1750		
		THD = 1%, V _{BAT} = 3.6 V, f = 1 kHz		1900		
		THD = 1%, V _{BAT} = 2.5 V, f = 1 kHz, R _L = 4 Ω + 33 μH		1460		
		THD = 1%, V _{BAT} = 3.0 V, f = 1 kHz, R _L = 4 Ω + 33 μH		1800		
		THD = 1%, V _{BAT} = 3.6 V, f = 1 kHz, R _L = 4 Ω + 33 μH		2280		
V _O	Peak output voltage	THD = 1%, V _{BAT} = 3.6 V, f = 1 kHz, 6 dB crest factor sine burst, no clipping		5.45		V
A _V	Voltage gain		19.5	20	20.5	dB
V _{OOS}	Output offset voltage			2	10	mV
	Short-circuit protection threshold current			2		A
R _{IN}	Input impedance (per input pin)	A _V = 20 dB		24		kΩ
	Input impedance in shutdown (per input pin)	EN = 0 V		1300		
Z _O	Output impedance in shutdown			2		kΩ
	Boost converter auto-pass through threshold	Class-D output voltage threshold when boost converter automatically turns on		2		V _{PK}
f _{CLASS-D}	Class-D switching frequency		275	300	325	kHz
η	Class-D and boost combined efficiency	P _O = 1 W, V _{BAT} = 3.6 V		82%		

Operating Characteristics (接下页)

 VBAT = 3.6 V, EN = VBAT, AGC = GND, T_A = 25°C, R_L = 8 Ω + 33 μH (unless otherwise noted)

PARAMETER		TEST CONDITIONS	MIN	TYP	MAX	UNIT
E _N	Noise output voltage	A-weighted		49		μV _{RMS}
		Unweighted		65		
SNR	Signal-to-noise ratio	1.7 W, R _L = 8 Ω + 33 μH. A-weighted		97		dB
		1.7 W, R _L = 8 Ω + 33 μH. Unweighted		95		
		2 W, R _L = 4 Ω + 33 μH. A-weighted		95		
		2 W, R _L = 4 Ω + 33 μH. Unweighted		93		
THD+N	Total harmonic distortion plus noise ⁽¹⁾	P _O = 100 mW, f = 1 kHz		0.06%		
		P _O = 500 mW, f = 1 kHz		0.07%		
		P _O = 1.7 W, f = 1 kHz, R _L = 8 Ω + 33 μH		0.07%		
		P _O = 2 W, f = 1 kHz, R _L = 4 Ω + 33 μH		0.15%		
	THD+N added to other audio signal connected at amplifier input during shutdown			0.02%		
AC PSRR	AC-Power supply ripple rejection (output referred)	200 mV _{PP} square ripple, V _{BAT} = 3.8 V, f = 217 Hz		62.5		dB
		200 mV _{PP} square ripple, V _{BAT} = 3.8 V, f = 1 kHz		62.5		
AC CMRR	AC-Common mode rejection ratio (output referred)	200 mV _{PP} square ripple, V _{BAT} = 3.8 V, f = 217 Hz		71		dB
		200 mV _{PP} square ripple, V _{BAT} = 3.8 V, f = 1 kHz		71		
AUTOMATIC GAIN CONTROL						
	AGC maximum attenuation			10		dB
	AGC attenuation resolution			0.5		dB
	AGC attack time (gain decrease)			20		μs/dB
	AGC release time (gain increase)			1.6		s/dB
	Gain vs VBAT slope	VBAT < inflection point		7.5		dB/V
	AGC inflection point (Note: AGC pin voltage is read only at device power-up. A device power cycle is required to change AGC inflection points.)	AGC = Float		3.25		V
		AGC = GND		3.55		
		AGC = VBAT		3.75		

(1) A-weighted

8.7 Typical Characteristics

VBAT = 3.6 V, C_I = 1 μF, C_{BOOST} = 22 μF, L_{BOOST} = 2.2 μH, EN = VBAT, and Load = 8 Ω + 33 μH, no ferrite bead unless otherwise specified.



图 1. Output Power vs Supply Voltage



图 2. Output Power vs Supply Voltage

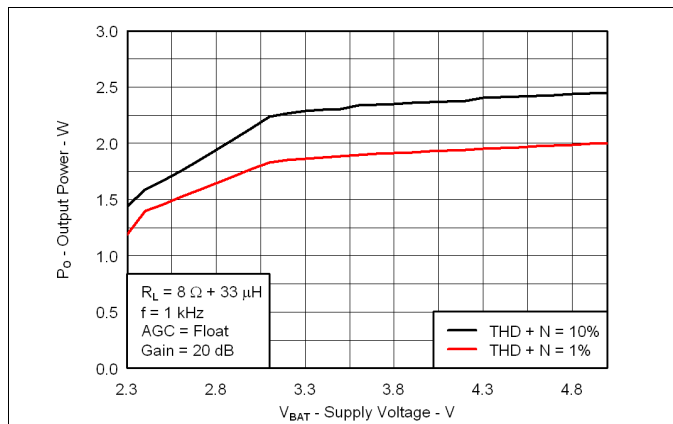

图 3. Total Supply Current vs Output Power

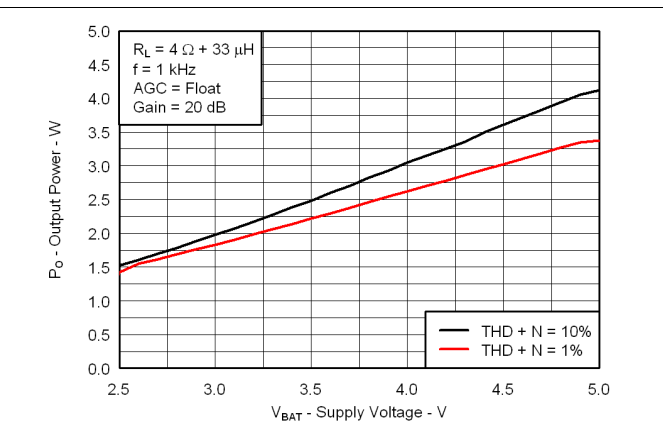

图 4. Total Supply Current vs Output Power

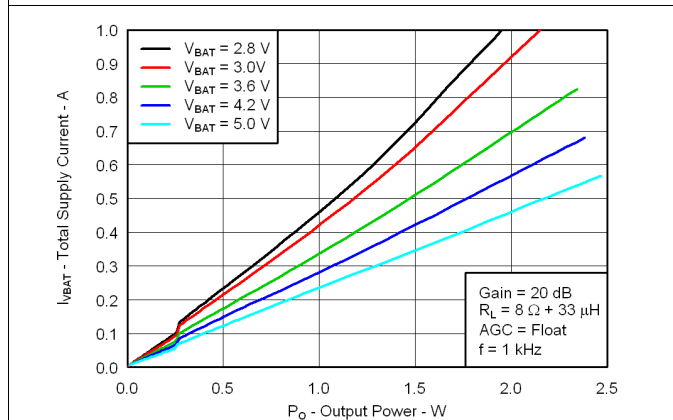

图 5. Total Harmonic Distortion + Noise vs Frequency

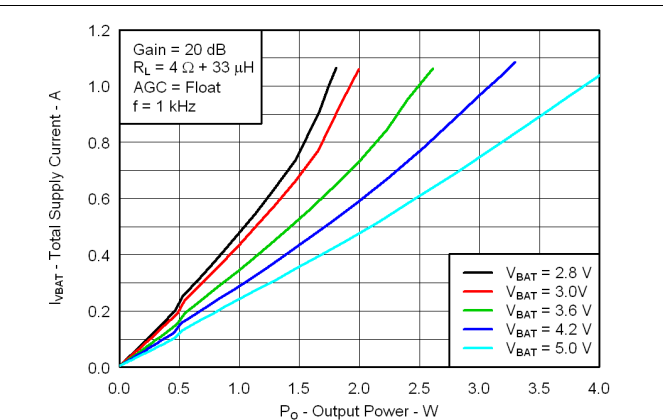

图 6. Total Harmonic Distortion + Noise vs Frequency

Typical Characteristics (接下页)

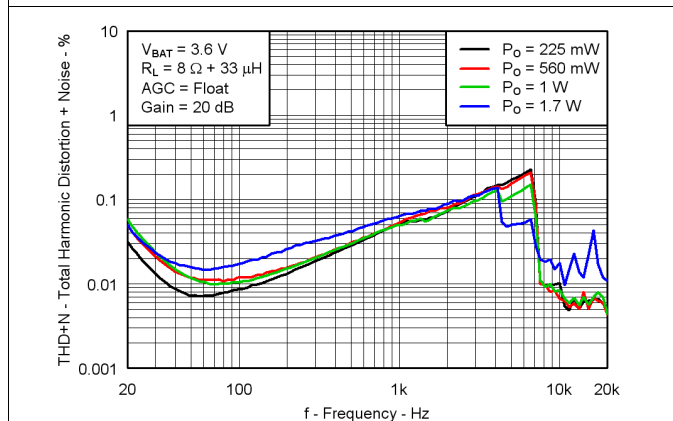
$V_{BAT} = 3.6\text{ V}$, $C_1 = 1\ \mu\text{F}$, $C_{BOOST} = 22\ \mu\text{F}$, $L_{BOOST} = 2.2\ \mu\text{H}$, $EN = V_{BAT}$, and Load = $8\ \Omega + 33\ \mu\text{H}$, no ferrite bead unless otherwise specified.

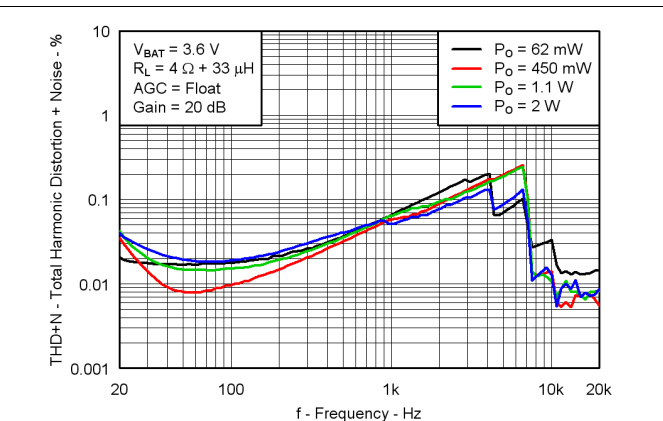
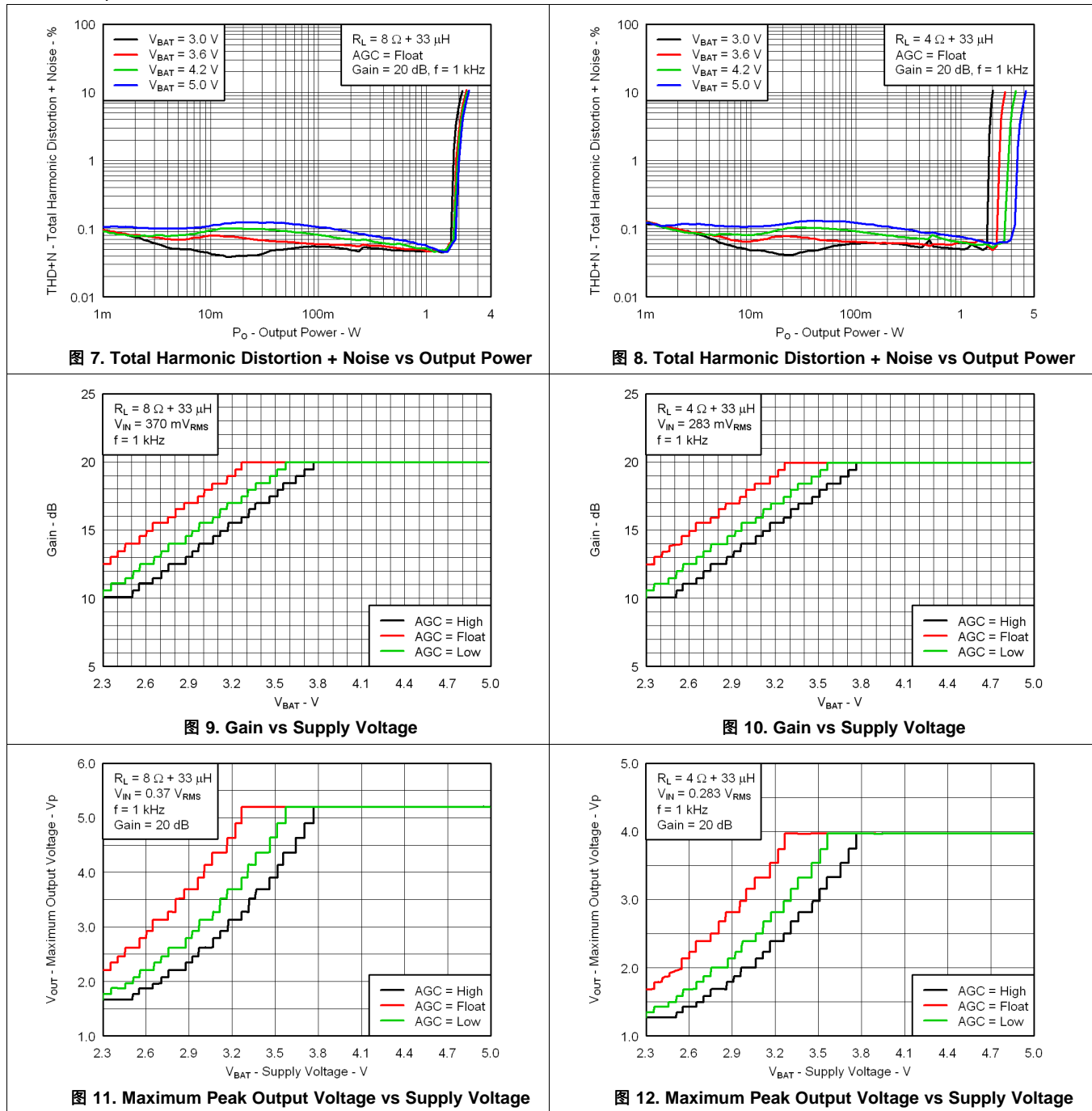

Typical Characteristics (接下页)

VBAT = 3.6 V, C₁ = 1 μF, C_{BOOST} = 22 μF, L_{BOOST} = 2.2 μH, EN = VBAT, and Load = 8 Ω + 33 μH, no ferrite bead unless otherwise specified.

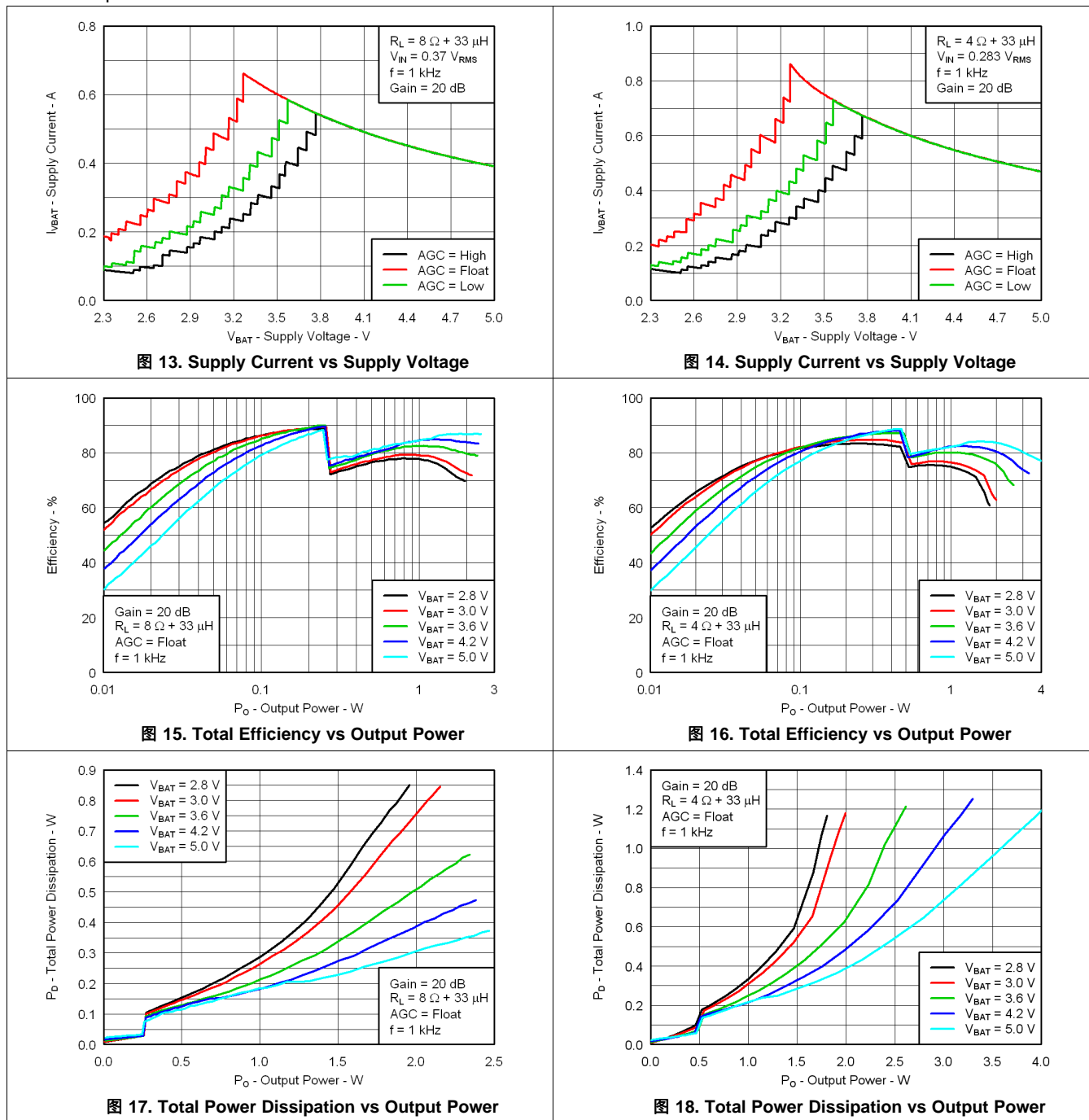

Typical Characteristics (接下页)

$V_{BAT} = 3.6\text{ V}$, $C_1 = 1\ \mu\text{F}$, $C_{BOOST} = 22\ \mu\text{F}$, $L_{BOOST} = 2.2\ \mu\text{H}$, $EN = V_{BAT}$, and Load = $8\ \Omega + 33\ \mu\text{H}$, no ferrite bead unless otherwise specified.



图 19. Quiescent Supply Current vs Supply Voltage



图 20. Supply Ripple Rejection vs Frequency

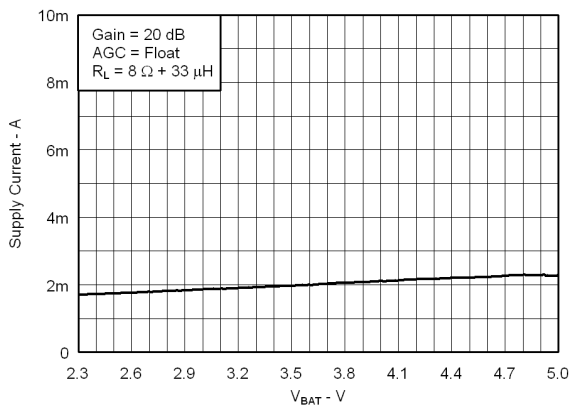

图 21. Common Mode Rejection Ratio vs Frequency

9 Parameter Measurement Information

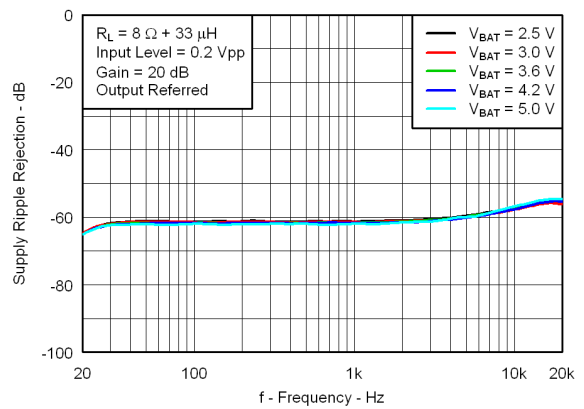
All parameters are measured according to the conditions described in the [Specifications](#) section.

Many audio analyzers will not give the correct readings on a Class-D amplifier without additional filtering, even if they have an internal low-pass filter. A RC 30kHz low-pass filter (100-Ω, 47n-F) is implemented to reduce the remaining noise frequencies from the PWM carrier signal. This filter was used on each output for the data sheet graphs.

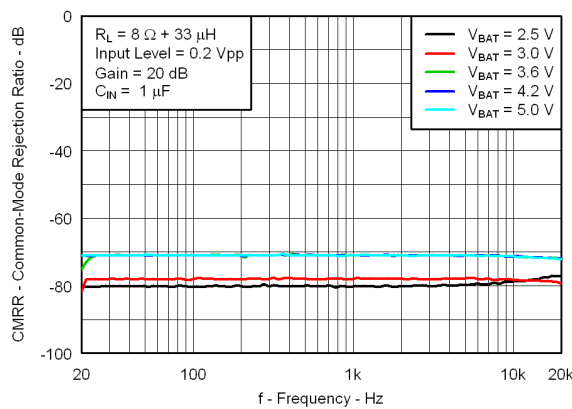
10 Detailed Description

10.1 Overview

The TPA2025D1 is a constant output, high efficiency Class-D audio amplifier with battery tracking AGC technology and an integrated Class-G boost converter. This features give the device a great performance and enhances efficiency at low output power. The TPA2025D1 can drive up to 1.9 W into an 8-Ω speaker (1% THD+N).

The built-in boost converter operates from a battery supply voltage and generates a higher output voltage PVDD at 5.75 V that drives the supply voltage of the Class-D amplifier. This provides a louder audio output than a stand-alone amplifier directly connected to the battery.

The battery tracking AGC adjusts the Class-D gain to limit battery current at lower battery voltage. This lets the device to extend the battery life while playing audio, typically with 85% efficiency. When the battery voltage is below a certain threshold voltage, The TPA2025D1 lowers the audio loudness. The threshold is selectable with an external pin.

The TPA2025D1 has an integrated low-pass filter to improve the RF rejection and reduce DAC out-of-band noise, increasing the signal-to-noise ratio (SNR). The features included in this device allow it to be used in a wide range of portable applications.

10.2 Functional Block Diagram

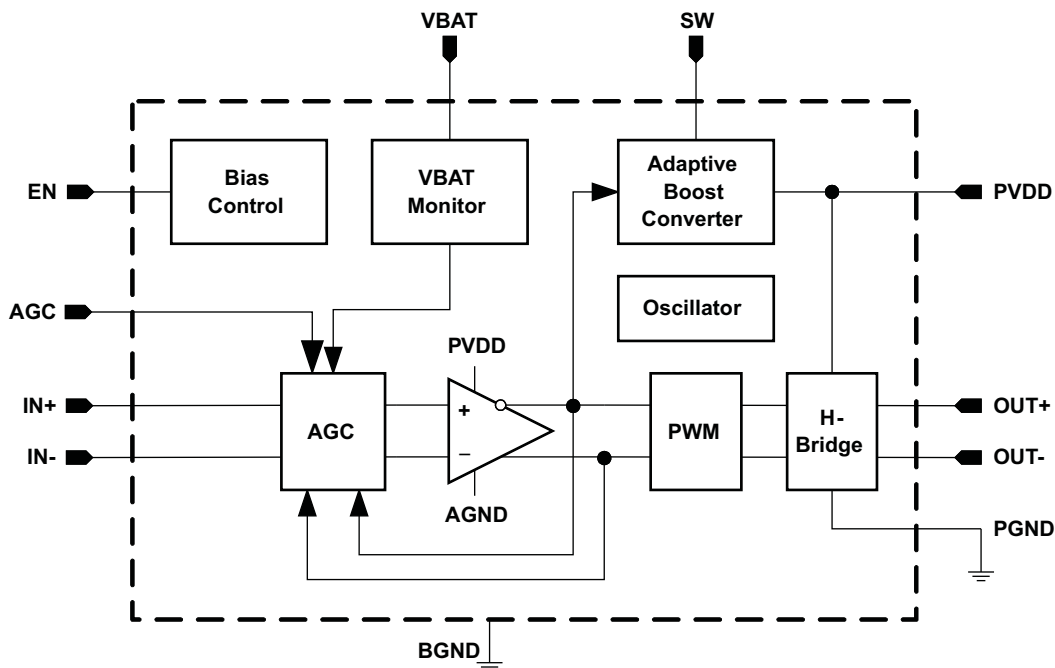

10.3 Feature Description

10.3.1 Battery Tracking Automatic Gain Control (AGC)

TPA2025D1 monitors the battery voltage and automatically reduces the gain when the battery voltage is below a certain threshold voltage, which is defined as inflection point. Although battery tracking AGC lowers the audio loudness, it prevents high battery current at end-of-charge battery voltage. The inflection point is selectable at AGC pin. When the amplifier is turned on, the gain is set according to battery voltage and selected inflection point.

图 22 shows the plot of gain as a function of battery supply voltage. The default slope is 7.5 dB/V. When battery voltage drops below inflection point by 1 V, AGC reduces the gain by 7.5 dB. The TPA2025D1 can only operate at one slope.



图 22. Gain vs Battery voltage

10.3.2 Boost Converter Auto Pass Through (APT)

The TPA2025D1 consists of an adaptive boost converter and a Class-D amplifier. The boost converter operates from the supply voltage, V_{BAT} , and generates a higher output voltage $PVDD$ at 5.75 V. $PVDD$ drives the supply voltage of the Class-D amplifier. This improves loudness over non-boosted solutions. The boost converter has a “Pass Through” mode in which it turns off automatically and $PVDD$ is directly connected to V_{BAT} through an internal bypass switch.

The boost converter is adaptive and operates between pass through mode and boost mode depending on the output audio signal amplitude. When the audio output amplitude exceeds the “auto pass through” (APT) threshold, the boost converter is activated automatically and goes to boost mode. The transition time from normal mode to boost mode is less than 3 ms. TPA2025D1’s APT threshold is fixed at 2 Vpk. When the audio output signal is below APT threshold, the boost converter is deactivated and goes to pass through mode. The adaptive boost converter maximizes system efficiency in lower audio output level.

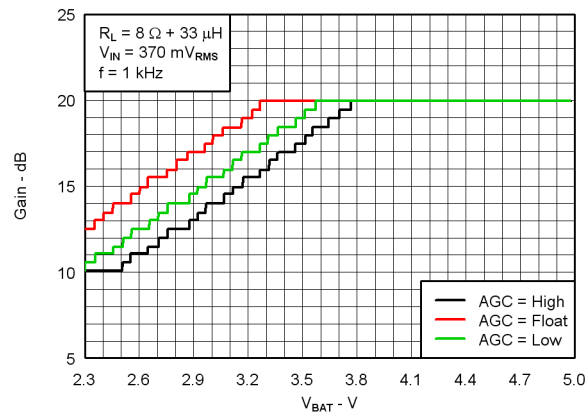
The battery AGC is independent of APT threshold. The AGC operates in both boost-active and APT modes.

图 23 shows how the adaptive boost converter behaves with a typical audio signal.

Feature Description (接下页)



图 23. Adaptive Boost Converter with Typical Music Playback

10.3.3 Short Circuit Auto-Recovery

When a short circuit event happens, the TPA2025D1 goes to low duty cycle mode and tries to reactivate itself every 1.6 seconds. This auto-recovery continues until the short circuit event stops. This feature protects the device without affecting its long term reliability.

10.3.4 Thermal Protection

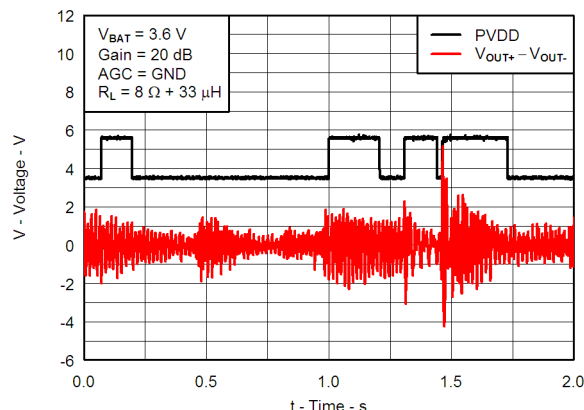
It is important to operate the TPA2025D1 at temperatures lower than its maximum operating temperature. The maximum ambient temperature depends on the heat-sinking ability of the PCB system. Given θ_{JA} of 97.3°C/W, the maximum allowable junction temperature of 150°C, and the internal dissipation of 0.5 W for 1.9 W, 8 Ω load, 3.6 V supply, the maximum ambient temperature is calculated as:

$$T_{A,MAX} = T_{J,MAX} - \theta_{JA} P_D = 150^{\circ}\text{C} - (97.3^{\circ}\text{C/W} \times 0.5\text{W}) = 101.4^{\circ}\text{C}$$

The calculated maximum ambient temperature is 101.4°C at maximum power dissipation at 3.6 V supply and 8 Ω load. The TPA2025D1 is designed with thermal protection that turns the device off when the junction temperature surpasses 150°C to prevent damage to the IC.

10.3.5 Operation with DACs and Codecs

Large noise voltages can be present at the output of $\Delta\Sigma$ DACs and CODECs, just above the audio frequency (e.g: 80 kHz with a 300 mV_{P-P}). This out-of-band noise is due to the noise shaping of the delta-sigma modulator in the DAC. Some Class-D amplifiers have higher output noise when used in combination with these DACs and CODECs. This is because out-of-band noise from the CODEC/DAC mixes with the Class-D switching frequencies in the audio amplifier input stage. The TPA2025D1 has a built-in low-pass filter with cutoff frequency at 55 kHz that reduces the out-of-band noise and RF noise, filtering out-of-band frequencies that could degrade in-band noise performance. This built-in filter also prevents AGC errors due to out-of-band noise. The TPA2025D1 AGC calculates gain based on input signal amplitude only. If driving the TPA2025D1 input with 4th-order or higher $\Delta\Sigma$ DACs or CODECs, add an R-C low pass filter at each of the audio inputs (IN+ and IN-) of the TPA2025D1 to ensure best performance. The recommended resistor value is 100 Ω and the capacitor value of 47 nF.

10.4 Device Functional Modes

10.4.1 Operation Below AGC Threshold

When the battery power supply voltage is below a certain threshold voltage, the TPA2025D1 starts reducing the gain automatically. This AGC threshold is selected by external AGC pin at 3.25 V, 3.55 V and 3.75 V for FLOAT, LOW and HIGH levels respectively.

图 24 shows the operation of AGC in time domain.

Device Functional Modes (接下页)

图 24. Relationship Between Supply Voltage and Gain in Time Domain

- Phase 1 Battery discharging normally; supply voltage is above inflection point; audio gain remains at 20 dB.
- Phase 2 Battery voltage decreases below inflection point. AGC responds in 10 μ s and reduces gain by one step (0.5 dB)
- Phase 3 Battery voltage continues to decrease. AGC continues to reduce gain. The rate of gain decrease is defined as attack time. TPA2025D1's attack time is 20 μ s/dB.
- Phase 4 Battery voltage is constant. AGC stops reducing gain.
- Phase 5 Battery voltage decreases suddenly. AGC reduces gain multiple steps. (time scale from this phase is longer) Release time counter resets every end of attack event.
- Phase 6 Release time has elapsed. Battery voltage returns to previous level. AGC increases gain by one step. TPA2025D1's release time is 1.6 s/dB
- Phase 7 Battery voltage remains constant. AGC continues to increase gain until it reaches steady state gain value defined in [图 22](#).
- Phase 8 Battery voltage is recharged to above inflection point. AGC continues to increase gain until it reaches 20 dB.

10.4.2 Shutdown Mode

The TPA2025D1 can be put in shutdown mode when asserting EN pin to a logic LOW. While in shutdown mode, the device output stage is turned off and the current consumption is very low. The device exits shutdown mode when a HIGH logic level is applied to EN pin.

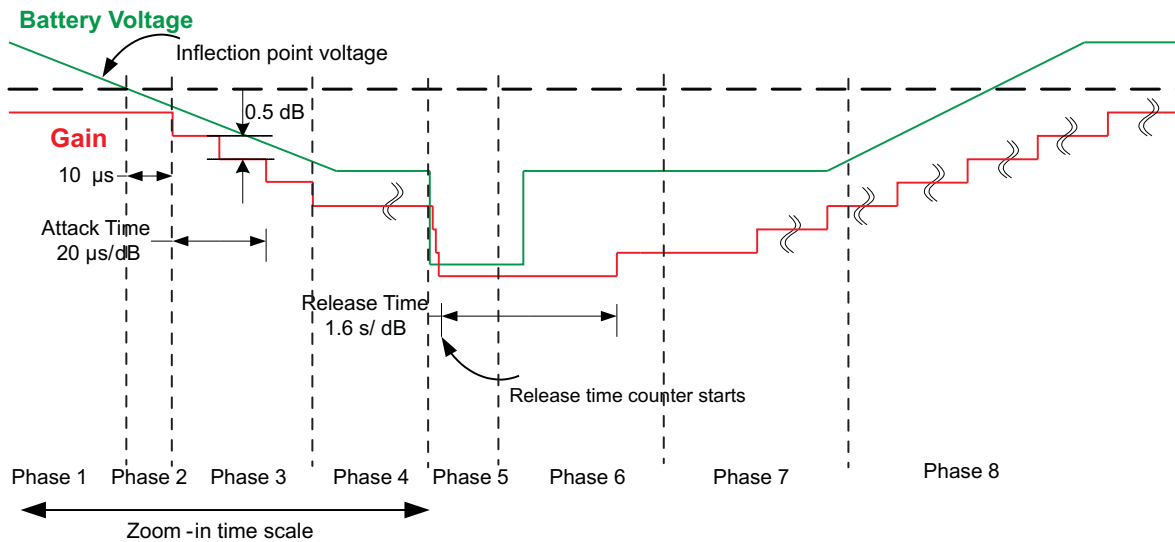
11 Application and Implementation

注

Information in the following applications sections is not part of the TI component specification, and TI does not warrant its accuracy or completeness. TI's customers are responsible for determining suitability of components for their purposes. Customers should validate and test their design implementation to confirm system functionality.

11.1 Application Information

The TPA2025D1 is a Class D amplifier with integrated automatic gain control and boost converter. This device is capable of drive up to 1.9W to 8-Ω Speaker (1% THD+N). TPA2025D1 starts operating when setting EN pin to HIGH level. The device enters in shutdown mode when asserting EN to LOW level. AGC pin connection sets the threshold where the device will start reducing the output amplitude. The selectable threshold voltages are specified in the [Operating Characteristics](#) section. In order to measure the TPA2025D1 output with an analyzer, a 30kHz Low pass filter should be implemented.

11.2 Typical Application

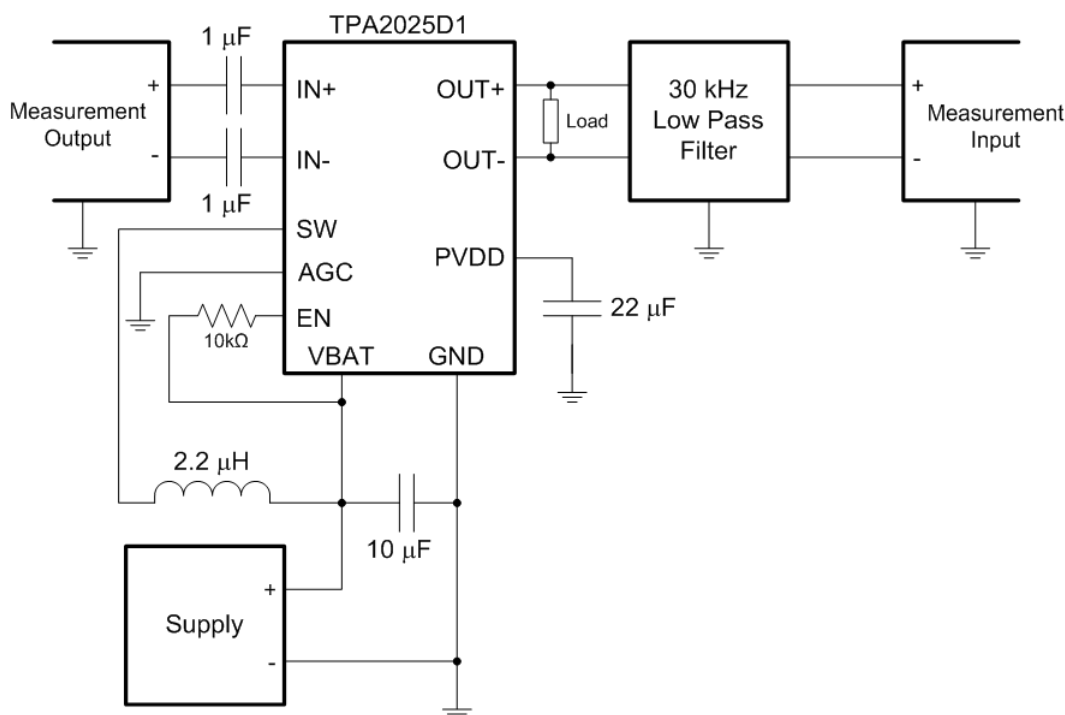

- (1) The 1-μF input capacitors on IN+ and IN- were shorted for input common-mode voltage measurements.
- (2) A 33-μH inductor was placed in series with the load resistor to emulate a small speaker for efficiency measurements.
- (3) The 30-kHz low-pass filter is required even if the analyzer has an internal low-pass filter. An R-C low-pass filter (100 Ω, 47 nF) is used on each output for the data sheet graphs.

图 25. Typical Application Schematic

Typical Application (接下页)

11.2.1 Design Requirements

For this design example, use the parameters listed in 表 1.

表 1. Design Parameters

PARAMETER	VALUE
Supply voltage range	2.5 V - 5.2 V
Input voltage range	0 V - 5 V
Peak output voltage	5.45 V
Max output current	1.8 A

11.2.2 Detailed Design Procedure

11.2.2.1 Boost Converter Component Section

The critical external components are summarized in the following table:

PARAMETER	TEST CONDITIONS	MIN	TYP	MAX	UNIT
Boost converter inductor	At 30% rated DC bias current of the inductor	1.5	2.2	4.7	μH
Boost converter input capacitor		4.7		10	μF
Boost converter output capacitor	Working capacitance biased at boost output voltage, if 4.7μH inductor is chosen, then minimum capacitance is 10 μF	4.7		22	μF

11.2.2.1.1 Inductor Equations

Inductor current rating is determined by the requirements of the load. The inductance is determined by two factors: the minimum value required for stability and the maximum ripple current permitted in the application. Use 公式 1 to determine the required current rating. 公式 1 shows the approximate relationship between the average inductor current, I_L , to the load current, load voltage, and input voltage (I_{PVDD} , $PVDD$, and $VBAT$, respectively). Insert I_{PVDD} , $PVDD$, and $VBAT$ into Equation 1 and solve for I_L . The inductor must maintain at least 90% of its initial inductance value at this current.

$$I_L = I_{PVDD} \times \left(\frac{PVDD}{VBAT \times 0.8} \right) \quad (1)$$

Ripple current, ΔI_L , is peak-to-peak variation in inductor current. Smaller ripple current reduces core losses in the inductor and reduces the potential for EMI. Use 公式 2 to determine the value of the inductor, L . 公式 2 shows the relationship between inductance L , $VBAT$, $PVDD$, the switching frequency, f_{BOOST} , and ΔI_L . Insert the maximum acceptable ripple current into 公式 2 and solve for L .

$$L = \frac{VBAT \times (PVDD - VBAT)}{\Delta I_L \times f_{BOOST} \times PVDD} \quad (2)$$

ΔI_L is inversely proportional to L . Minimize ΔI_L as much as is necessary for a specific application. Increase the inductance to reduce the ripple current. Do not use greater than 4.7 μH, as this prevents the boost converter from responding to fast output current changes properly. If using above 3.3 μH, then use at least 10 μF capacitance on $PVDD$ to ensure boost converter stability.

The typical inductor value range for the TPA2025D1 is 2.2 μH to 3.3 μH. Select an inductor with less than 0.5 Ω dc resistance, DCR. Higher DCR reduces total efficiency due to an increase in voltage drop across the inductor.

表 2. Sample Inductors

L (μH)	SUPPLIER	COMPONENT CODE	SIZE (LxWxH mm)	DCR TYP (m Ω)	I _{SAT} MAX (A)	C RANGE
2.2	Toko	1239AS-H-2R2N=P2	2.5 x 2.0 x 1.2	96	2.3	4.7 - 22 μF / 16 V 6.8 - 22 μV / 10 V
2.2	Coilcraft	XFL4020-222MEC	4.0 x 4.0 x 2.15	22	3.5	
3.3	Toko	1239AS-H-3R3N=P2	2.5 x 2.0 x 1.2	160	2.0	10 - 22 μF / 10 V
3.3	Coilcraft	XFL4020-332MEC	4.0 x 4.0 x 2.15	35	2.8	

11.2.2.1.2 Boost Converter Capacitor Selection

The value of the boost capacitor is determined by the minimum value of working capacitance required for stability and the maximum voltage ripple allowed on PVDD in the application. Working capacitance refers to the available capacitance after derating the capacitor value for DC bias, temperature, and aging. Do not use any component with a working capacitance less than 4.7 μF . This corresponds to a 4.7 $\mu\text{F}/16\text{ V}$ capacitor, or a 6.8 $\mu\text{F}/10\text{ V}$ capacitor.

Do not use above 22 μF capacitance as it will reduce the boost converter response time to large output current transients.

公式 3 shows the relationship between the boost capacitance, C, to load current, load voltage, ripple voltage, input voltage, and switching frequency (I_{PVDD} , PVDD, ΔV , VBAT, and f_{BOOST} respectively).

Insert the maximum allowed ripple voltage into 公式 3 and solve for C. The 1.5 multiplier accounts for capacitance loss due to applied dc voltage and temperature for X5R and X7R ceramic capacitors.

$$C = 1.5 \times \frac{I_{\text{PVDD}} \times (\text{PVDD} - \text{VBAT})}{\Delta\text{V} \times f_{\text{BOOST}} \times \text{PVDD}} \quad (3)$$

11.2.2.1.3 Boost Terms

The following is a list of terms and definitions used in the boost equations.

C	Minimum boost capacitance required for a given ripple voltage on PVDD.
L	Boost inductor
f_{BOOST}	Switching frequency of the boost converter.
I_{PVDD}	Current pulled by the Class-D amplifier from the boost converter.
I_L	Average current through the boost inductor.
PVDD	Supply voltage for the Class-D amplifier. (Voltage generated by the boost converter output)
VBAT	Supply voltage to the IC.
ΔI_L	Ripple current through the inductor.
ΔV	Ripple voltage on PVDD.

11.2.2.2 Input Capacitors

Input audio DC decoupling capacitors are recommended. The input audio DC decoupling capacitors prevents the AGC from changing the gain due to audio DAC output offset. The input capacitors and TPA2025D1 input impedance form a high-pass filter with the corner frequency, f_c , determined in 公式 4.

Any mismatch in capacitance between the two inputs will cause a mismatch in the corner frequencies. Severe mismatch may also cause turn-on pop noise. Choose capacitors with a tolerance of $\pm 10\%$ or better.

$$f_c = \frac{1}{(2 \times \pi \times R_1 C_1)} \quad (4)$$

11.2.2.3 Speaker Load Limitation

Speakers are non-linear loads with varying impedance (magnitude and phase) over the audio frequency. A portion of speaker load current can flow back into the boost converter output via the Class-D output H-bridge high-side device. This is dependent on the speaker's phase change over frequency, and the audio signal amplitude and frequency content. Most portable speakers have limited phase change at the resonant frequency, typically no more than 40 or 50 degrees. To avoid excess flow-back current, use speakers with limited phase change. Otherwise, flow-back current could drive the PVDD voltage above the absolute maximum recommended operational voltage.

Confirm proper operation by connecting the speaker to the TPA2025D1 and driving it at maximum output swing. Observe the PVDD voltage with an oscilloscope. In the unlikely event the PVDD voltage exceeds 6.5 V, add a 6.8 V Zener diode between PVDD and ground to ensure the TPA2025D1 operates properly. The amplifier has thermal overload protection and deactivates if the die temperature exceeds 150°C. It automatically reactivates once die temperature returns below 150°C. Built-in output over-current protection deactivates the amplifier if the speaker load becomes short-circuited. The amplifier automatically restarts 1.6 seconds after the over-current event. Although the TPA2025D1 Class-D output can withstand a short between OUT+ and OUT-, do not connect either output directly to GND, VDD, or VBAT as this could damage the device.

11.2.3 Application Curve

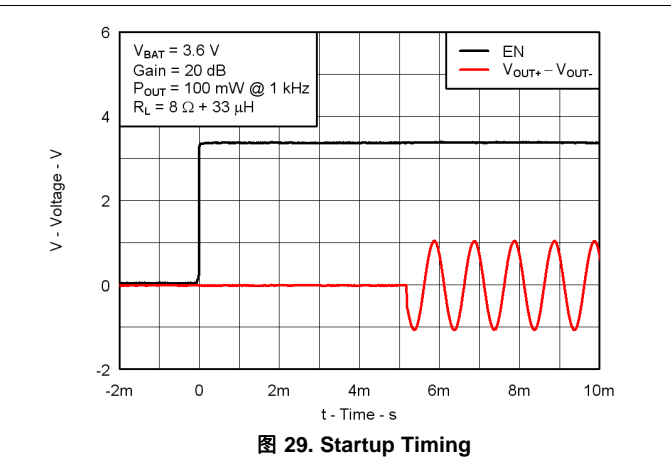
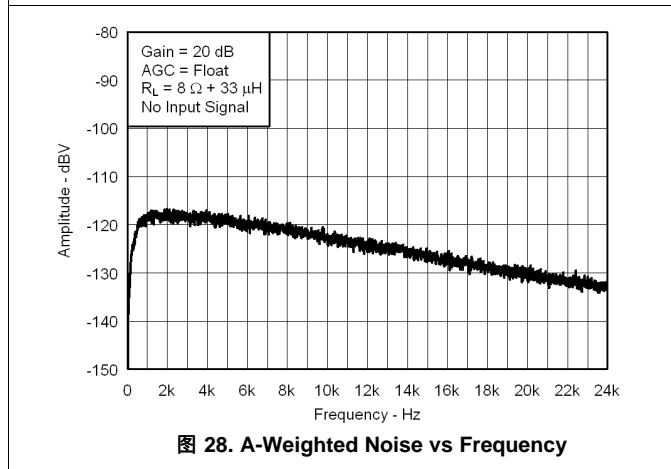
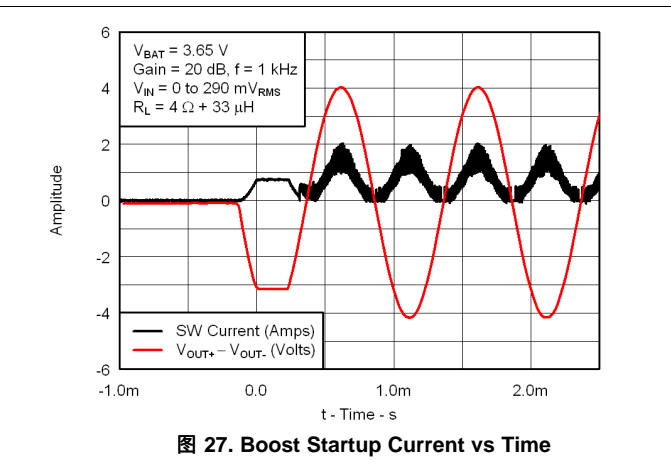
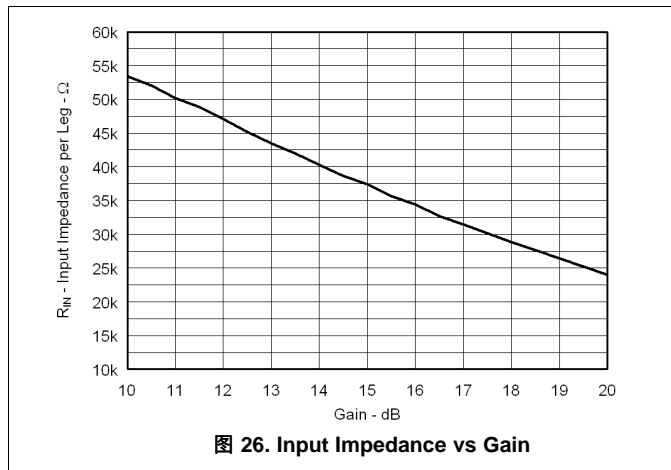



图 30. Shutdown Timing



图 31. EMC Performance $P_o = 750$ mW with 2 Inch Speaker Cable

12 Power Supply Recommendations

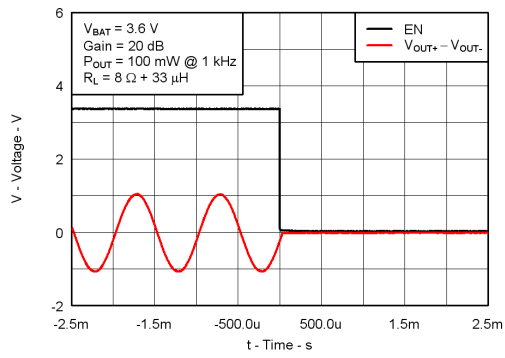
The TPA2025D1 is designed to operate from an input voltage supply range between 2.5-V and 5.2-V. Therefore, the output voltage range of power supply should be within this range and well regulated. The current capability of upper power should not exceed the maximum current limit of the power switch.

12.1 Power Supply Decoupling Capacitors

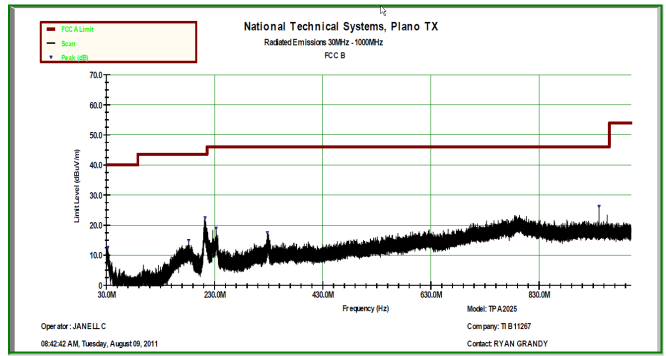
The TPA2025D1 is a high-performance Class-D audio amplifier that requires adequate power supply decoupling. Adequate power supply decoupling to ensures that the efficiency is high and total harmonic distortion (THD) is low.

Place a low equivalent-series-resistance (ESR) ceramic capacitor, typically 0.1 μF , within 2 mm of the VBAT ball. This choice of capacitor and placement helps with higher frequency transients, spikes, or digital hash on the line. Additionally, placing this decoupling capacitor close to the TPA2025D1 is important, as any parasitic resistance or inductance between the device and the capacitor causes efficiency loss. In addition to the 0.1 μF ceramic capacitor, place a 2.2 μF to 10 μF capacitor on the VBAT supply trace. This larger capacitor acts as a charge reservoir, providing energy faster than the board supply, thus helping to prevent any droop in the supply voltage.

13 Layout

13.1 Layout Guidelines

Decoupling capacitors should be placed as close to the supply voltage pin as possible. For this device a 10- μF high-quality ceramic capacitor is recommended.

表 3. Land Pattern Dimensions^{(1) (2) (3) (4)}

SOLDER PAD DEFINITIONS	COPPER PAD	SOLDER MASK ⁽⁵⁾ OPENING	COPPER THICKNESS	STENCIL ^{(6) (7)} OPENING	STENCIL THICKNESS
Nonsolder mask defined (NSMD)	275 μm (+0.0, -25 μm)	375 μm (+0.0, -25 μm)	1 oz max (32 μm)	275 μm x 275 μm Sq. (rounded corners)	125 μm thick

- (1) Circuit traces from NSMD defined PWB lands should be 75 μm to 100 μm wide in the exposed area inside the solder mask opening. Wider trace widths reduce device stand off and impact reliability.
- (2) Best reliability results are achieved when the PWB laminate glass transition temperature is above the operating the range of the intended application.
- (3) Recommend solder paste is Type 3 or Type 4.
- (4) For a PWB using a Ni/Au surface finish, the gold thickness should be less 0.5 μm to avoid a reduction in thermal fatigue performance.
- (5) Solder mask thickness should be less than 20 μm on top of the copper circuit pattern
- (6) Best solder stencil performance is achieved using laser cut stencils with electro polishing. Use of chemically etched stencils results in inferior solder paste volume control.
- (7) Trace routing away from WCSP device should be balanced in X and Y directions to avoid unintentional component movement due to solder wetting forces.

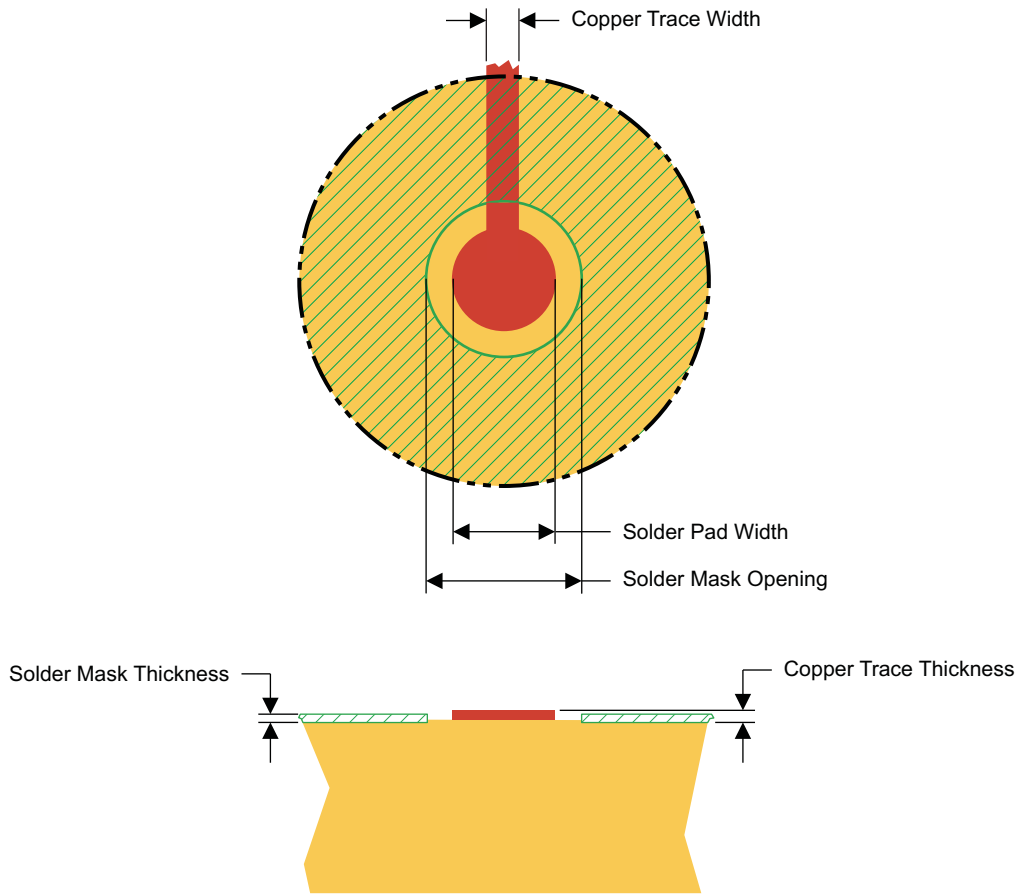

M0200-01

图 32. Land Pattern Dimensions

13.2 Layout Example

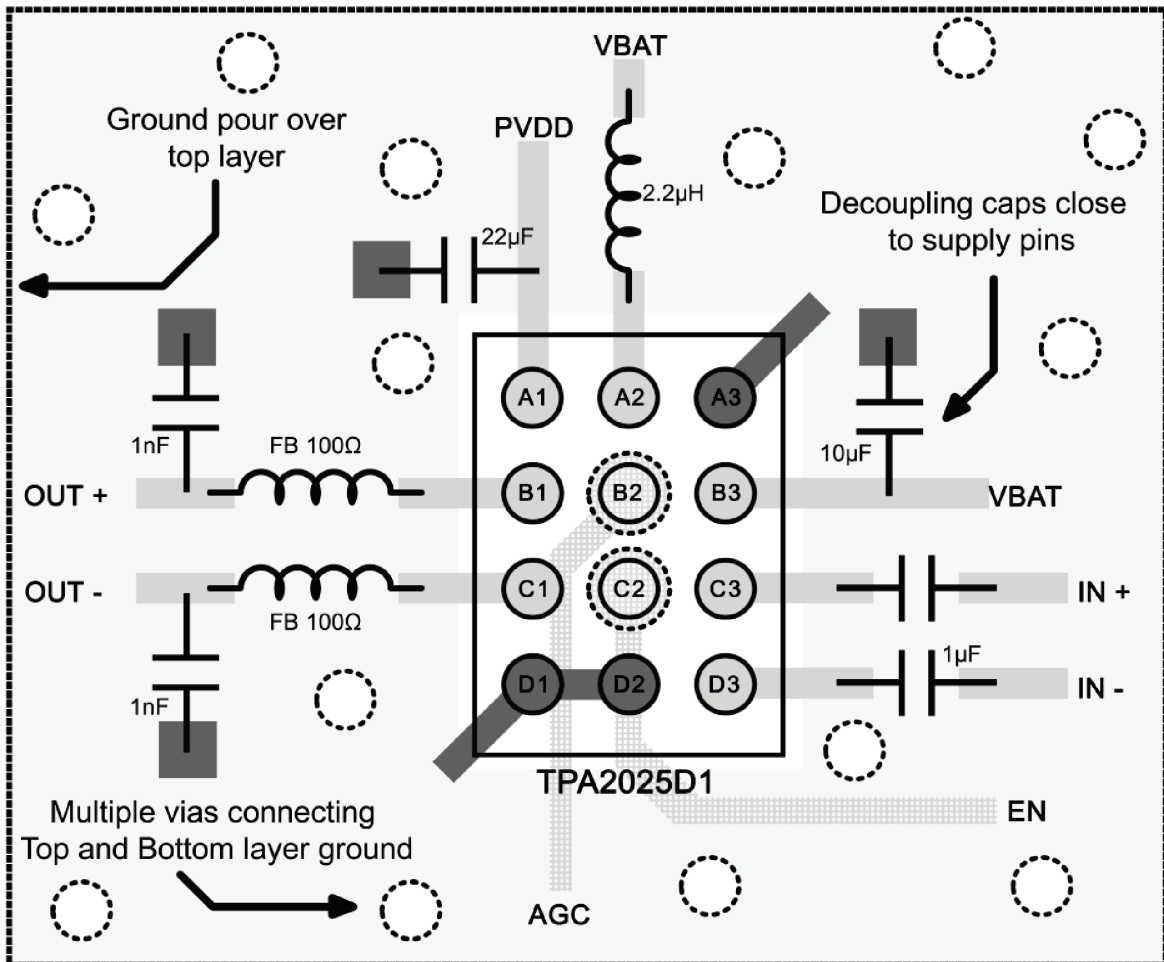

- Top Layer Ground pour
- Top Layer Signal Traces
- Pad to Top Layer Ground Pour
- Bottom Layer Signal Traces
- Via To Bottom Ground Plane
- Via to Bottom Layer Traces

图 33. TPA2025D1 Layout Example

14 器件和文档支持

14.1 商标

All trademarks are the property of their respective owners.

14.2 静电放电警告



这些装置包含有限的内置 ESD 保护。存储或装卸时，应将导线一起截短或将装置放置于导电泡棉中，以防止 MOS 门极遭受静电损伤。

14.3 术语表

[SLYZ022](#) — *TI* 术语表。

这份术语表列出并解释术语、首字母缩略词和定义。

15 机械、封装和可订购信息

以下页中包括机械、封装和可订购信息。 这些信息是针对指定器件可提供的最新数据。 这些数据会在无通知且不
对本文档进行修订的情况下发生改变。 欲获得该数据表的浏览器版本，请查阅左侧的导航栏。

PACKAGING INFORMATION

Orderable Device	Status (1)	Package Type	Package Drawing	Pins	Package Qty	Eco Plan (2)	Lead finish/ Ball material (6)	MSL Peak Temp (3)	Op Temp (°C)	Device Marking (4/5)	Samples
TPA2025D1YZGR	ACTIVE	DSBGA	YZG	12	3000	RoHS & Green	SNAGCU	Level-1-260C-UNLIM	-40 to 85	TPA2025D1	Samples
TPA2025D1YZGT	ACTIVE	DSBGA	YZG	12	250	RoHS & Green	SNAGCU	Level-1-260C-UNLIM	-40 to 85	TPA2025D1	Samples

(1) The marketing status values are defined as follows:

ACTIVE: Product device recommended for new designs.

LIFEBUY: TI has announced that the device will be discontinued, and a lifetime-buy period is in effect.

NRND: Not recommended for new designs. Device is in production to support existing customers, but TI does not recommend using this part in a new design.

PREVIEW: Device has been announced but is not in production. Samples may or may not be available.

OBSOLETE: TI has discontinued the production of the device.

(2) **RoHS:** TI defines "RoHS" to mean semiconductor products that are compliant with the current EU RoHS requirements for all 10 RoHS substances, including the requirement that RoHS substance do not exceed 0.1% by weight in homogeneous materials. Where designed to be soldered at high temperatures, "RoHS" products are suitable for use in specified lead-free processes. TI may reference these types of products as "Pb-Free".

RoHS Exempt: TI defines "RoHS Exempt" to mean products that contain lead but are compliant with EU RoHS pursuant to a specific EU RoHS exemption.

Green: TI defines "Green" to mean the content of Chlorine (Cl) and Bromine (Br) based flame retardants meet JS709B low halogen requirements of <=1000ppm threshold. Antimony trioxide based flame retardants must also meet the <=1000ppm threshold requirement.

(3) MSL, Peak Temp. - The Moisture Sensitivity Level rating according to the JEDEC industry standard classifications, and peak solder temperature.

(4) There may be additional marking, which relates to the logo, the lot trace code information, or the environmental category on the device.

(5) Multiple Device Markings will be inside parentheses. Only one Device Marking contained in parentheses and separated by a "~" will appear on a device. If a line is indented then it is a continuation of the previous line and the two combined represent the entire Device Marking for that device.

(6) Lead finish/Ball material - Orderable Devices may have multiple material finish options. Finish options are separated by a vertical ruled line. Lead finish/Ball material values may wrap to two lines if the finish value exceeds the maximum column width.

Important Information and Disclaimer:The information provided on this page represents TI's knowledge and belief as of the date that it is provided. TI bases its knowledge and belief on information provided by third parties, and makes no representation or warranty as to the accuracy of such information. Efforts are underway to better integrate information from third parties. TI has taken and continues to take reasonable steps to provide representative and accurate information but may not have conducted destructive testing or chemical analysis on incoming materials and chemicals. TI and TI suppliers consider certain information to be proprietary, and thus CAS numbers and other limited information may not be available for release.

In no event shall TI's liability arising out of such information exceed the total purchase price of the TI part(s) at issue in this document sold by TI to Customer on an annual basis.

TAPE AND REEL INFORMATION



QUADRANT ASSIGNMENTS FOR PIN 1 ORIENTATION IN TAPE



*All dimensions are nominal

Device	Package Type	Package Drawing	Pins	SPQ	Reel Diameter (mm)	Reel Width W1 (mm)	A0 (mm)	B0 (mm)	K0 (mm)	P1 (mm)	W (mm)	Pin1 Quadrant
TPA2025D1YZGR	DSBGA	YZG	12	3000	180.0	8.4	1.63	2.08	0.69	4.0	8.0	Q1
TPA2025D1YZGT	DSBGA	YZG	12	250	180.0	8.4	1.63	2.08	0.69	4.0	8.0	Q1

TAPE AND REEL BOX DIMENSIONS

*All dimensions are nominal

Device	Package Type	Package Drawing	Pins	SPQ	Length (mm)	Width (mm)	Height (mm)
TPA2025D1YZGR	DSBGA	YZG	12	3000	182.0	182.0	20.0
TPA2025D1YZGT	DSBGA	YZG	12	250	182.0	182.0	20.0

YZG (R-XBGA-N12)

DIE-SIZE BALL GRID ARRAY

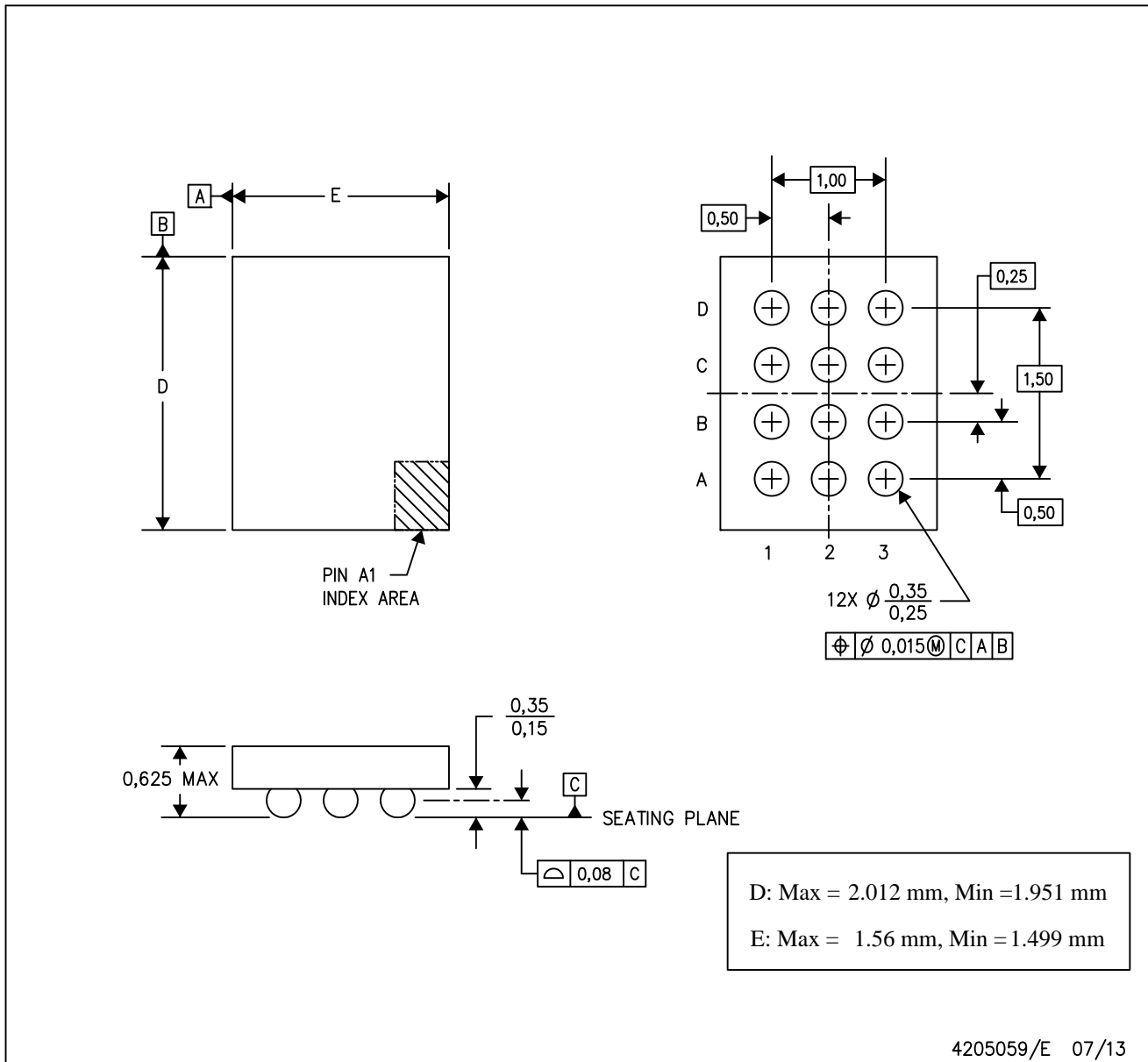

- NOTES: A. All linear dimensions are in millimeters. Dimensioning and tolerancing per ASME Y14.5M-1994.
 B. This drawing is subject to change without notice.
 C. NanoFree™ package configuration.

重要声明和免责声明

TI 提供技术和可靠性数据 (包括数据表)、设计资源 (包括参考设计)、应用或其他设计建议、网络工具、安全信息和其他资源, 不保证没有瑕疵且不做任何明示或暗示的担保, 包括但不限于对适销性、某特定用途方面的适用性或不侵犯任何第三方知识产权的暗示担保。

这些资源可供使用 TI 产品进行设计的熟练开发人员使用。您将自行承担以下全部责任: (1) 针对您的应用选择合适的 TI 产品, (2) 设计、验证并测试您的应用, (3) 确保您的应用满足相应标准以及任何其他安全、安保或其他要求。这些资源如有变更, 恕不另行通知。TI 授权您仅可将这些资源用于研发本资源所述的 TI 产品的应用。严禁对这些资源进行其他复制或展示。您无权使用任何其他 TI 知识产权或任何第三方知识产权。您应全额赔偿因在这些资源的使用中对 TI 及其代表造成的任何索赔、损害、成本、损失和债务, TI 对此概不负责。

TI 提供的产品受 TI 的销售条款 (<https://www.ti.com.cn/zh-cn/legal/termsofsale.html>) 或 [ti.com.cn](https://www.ti.com.cn) 上其他适用条款/TI 产品随附的其他适用条款的约束。TI 提供这些资源并不会扩展或以其他方式更改 TI 针对 TI 产品发布的适用的担保或担保免责声明。

邮寄地址: 上海市浦东新区世纪大道 1568 号中建大厦 32 楼, 邮政编码: 200122
Copyright © 2021 德州仪器半导体技术 (上海) 有限公司