

TPD4S311、TPD4S311A USB Type-C™ 端口保护器：V_{BUS} 短路过压和 IEC ESD 保护

1 特性

- 4 通道 V_{BUS} 短路过压保护 (CC1、CC2、SBU1、SBU2) : 可耐受 24V_{DC} 电压
- 4 通道 IEC 61000-4-2 ESD 保护 (CC1、CC2、SBU1、SBU2)
- CC1 和 CC2 过压保护 FET 可支持 V_{CONN} 通过电流
 - 400mA V_{CONN} 电流 (TPD4S311)
 - 600mA V_{CONN} 电流 (TPD4S311A)
- CC 引脚上提供 ±35V 浪涌保护 (TPD4S311A)
- SBU 引脚上提供 ±30V 浪涌保护 (TPD4S311A)
- 集成 CC 无电电池电阻器，可用于处理移动设备中的无电电池用例
- 1.69mm × 1.69mm DSBGA 封装

2 应用

- 台式计算机/主板
- 标准笔记本电脑
- Chromebook 和 WOA
- 集线站
- 端口/线缆适配器和加密狗
- 智能手机

3 说明

TPD4S311 是一款单芯片 USB Type-C 端口保护器件，可提供 20V V_{BUS} 短路过压保护和 IEC ESD 保护。

自从 USB Type-C 连接器发布以来，市场上已经发布了很多不符合 USB Type-C 规格的 USB Type-C 产品和配件。其中的一个示例就是仅在 V_{BUS} 线路上布设 20V 电压的 USB Type-C 电力输送适配器。USB Type-C 的另一个问题是，由于此小型连接器中的各引脚极为靠近，因此连接器的机械扭转和滑动可能使引脚短路。这可能导致 20V V_{BUS} 与 CC 和 SBU 引脚短路。此外，由于 Type-C 连接器中的各引脚极为靠近，所以存在碎屑和水气导致 20V V_{BUS} 引脚与 CC 和 SBU 引脚短路的严重问题。

这些非理想的设备和机械事件使得 CC 和 SBU 引脚必须能够承受 20V 的电压，即使这些引脚仅在 5V 或更低电压下工作。通过在 CC 和 SBU 引脚上提供过压保护，TPD4S311 可以使 CC 和 SBU 引脚耐受 20V 的电压，同时不会干扰正常运行。该器件将高压 FET 串联放置在 SBU 和 CC 线路上。当在这些线路上检测到高于 OVP 阈值的电压时，高压开关被打开，并且将系统的其余部分与连接器上存在的高压状态隔离。

最后，大多数系统都需要为其外部引脚应用 IEC 61000-4-2 系统级 ESD 保护。TPD4S311 为 CC1、CC2、SBU1 和 SBU2 引脚集成了 IEC 61000-4-2 ESD 保护，无需再在连接器上 (外部) 放置高电压 TVS 二极管。

器件信息⁽¹⁾

器件型号	封装	封装尺寸 (标称值)
TPD4S311	DSBGA (16)	1.69 mm × 1.69 mm
TPD4S311A	DSBGA (16)	1.69 mm × 1.69 mm

(1) 如需了解所有可用封装，请参阅数据表末尾的可订购产品附录。

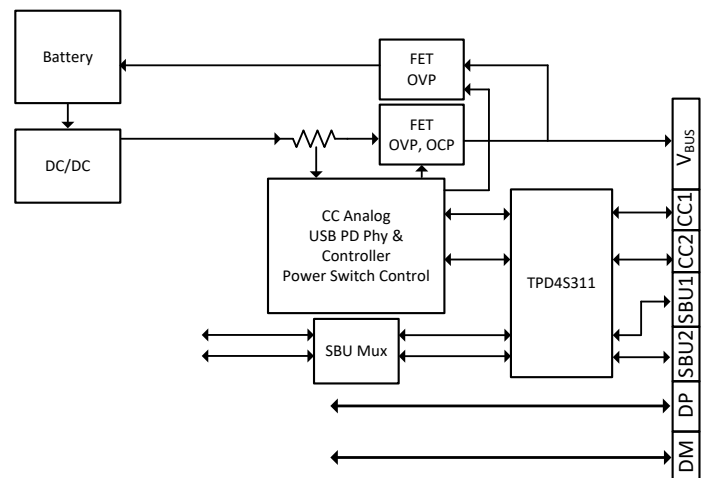

CC 和 SBU 过压保护



Table of Contents

1 特性.....	1	8.3 Feature Description.....	15
2 应用.....	1	8.4 Device Functional Modes.....	17
3 说明.....	1	9 Application and Implementation.....	18
4 Revision History.....	2	9.1 Application Information.....	18
5 Device Comparison Table.....	3	9.2 Typical Application.....	18
6 Pin Configuration and Functions.....	4	10 Power Supply Recommendations.....	23
7 Specifications.....	5	11 Layout.....	24
7.1 Absolute Maximum Ratings.....	5	11.1 Layout Guidelines.....	24
7.2 ESD Ratings—JEDEC Specification.....	5	11.2 Layout Example.....	24
7.3 ESD Ratings—IEC Specification.....	5	12 Device and Documentation Support.....	25
7.4 Recommended Operating Conditions.....	5	12.1 Documentation Support.....	25
7.5 Thermal Information.....	6	12.2 接收文档更新通知.....	25
7.6 Electrical Characteristics.....	6	12.3 支持资源.....	25
7.7 Timing Requirements.....	8	12.4 Trademarks.....	25
7.8 Typical Characteristics.....	9	12.5 静电放电警告.....	25
8 Detailed Description.....	14	12.6 术语表.....	25
8.1 Overview.....	14	13 Mechanical, Packaging, and Orderable Information.....	25
8.2 Functional Block Diagram.....	14		

4 Revision History

注：以前版本的页码可能与当前版本的页码不同

Changes from Revision B (August 2020) to Revision C (February 2021)	Page
• 添加了 A 版本器件.....	1
• Added A version of the device.....	3
• Added A version of the device to Absolute Maximum Ratings table.....	5
• Added A version to ESD Ratings—IEC Specification table.....	5
• Added A version to Recommended Operating Conditions table.....	5
• Added A version to Electrical Characteristics table.....	6
• Added A version of the device to Detailed Description section.....	16

Changes from Revision A (April 2020) to Revision B (August 2020)	Page
• 更新了整个文档中的表格、图和交叉参考的编号格式.....	1
• Added I _O row in Absolute Maximum Ratings table.....	5
• Deleted 1.2 A spec from Recommended Operating Conditions table.....	5
• Updated I _{VCONN} max current to 400 mA in Recommended Operating Conditions table.....	5
• Added table note to Recommended Operating Conditions table.....	5
• Updated 图 7-3 caption to 24 V.....	9
• Updated 图 7-4 caption to 24 V.....	9
• Updated 图 7-17 caption to 24 V.....	9
• Updated 图 7-18 caption to 24 V.....	9
• Updated 图 7-17	9
• Updated 图 7-18	9

Changes from Revision * (December 2019) to Revision A (September 2020)	Page
• 更新了附带链接的 应用 部分.....	1
• 将封装类型名称从 WCSP 更改为 DSBGA；全局更改.....	1

5 Device Comparison Table

Part Number	Channels and Protection	Vconn Current	CC On Resistance
TPD4S311	4-Ch (CC1, CC2, SBU1, SBU2) overvoltage protection. 4-Ch (CC1, CC2, SBU1, SBU2) IEC 61000-4-2 ESD protection.	400 mA	378 m Ω
TPD4S311A	4-Ch (CC1, CC2, SBU1, SBU2) overvoltage protection. 4-Ch (CC1, CC2, SBU1, SBU2) IEC 61000-4-2 ESD protection. 4-Ch (CC1, CC2, SBU1, SBU2) IEC 61000-4-5 Surge Protection.	600 mA	232 m Ω

6 Pin Configuration and Functions



图 6-1. YBF Package 16-Pin DSBGA

表 6-1. Pin Functions

PIN		TYPE ⁽¹⁾	DESCRIPTION
NO.	NAME		
A1	C_SBU2	I/O	Connector side of the SBU2 OVP FET. Connect to either SBU pin of the USB Type-C connector.
A2	C_CC1	I/O	Connector side of the CC1 OVP FET. Connect to either CC pin of the USB Type-C connector.
A3	C_CC2	I/O	Connector side of the CC2 OVP FET. Connect to either CC pin of the USB Type-C connector.
A4	VBIAS	P	Pin for ESD support capacitor. Place a 0.1- μ F capacitor on this pin to ground.
B1	C_SBU1	I/O	Connector side of the SBU1 OVP FET. Connect to either SBU pin of the USB Type-C connector.
B2	RPD_G1	I/O	Short to C_CC1 if dead battery resistors are needed. If dead battery resistors are not needed, short pin to GND.
B3	RPD_G2	I/O	Short to C_CC2 if dead battery resistors are needed. If dead battery resistors are not needed, short pin to GND.
B4	FLT	O	Open drain for fault reporting.
C1, C2, C3	GND	GND	Ground
C4	VPWR	P	2.7-V to 4.5-V power supply.
D1	SBU1	I/O	System side of the SBU1 OVP FET. Connect to either SBU pin of the SBU MUX.
D2	SBU2	I/O	System side of the SBU2 OVP FET. Connect to either SBU pin of the SBU MUX.
D3	CC1	I/O	System side of the CC1 OVP FET. Connect to either CC pin of the CC/PD controller.
D4	CC2	I/O	System side of the CC2 OVP FET. Connect to either CC pin of the CC/PD controller.

(1) I = input, O = output, I/O = input and output, GND = ground, P = power

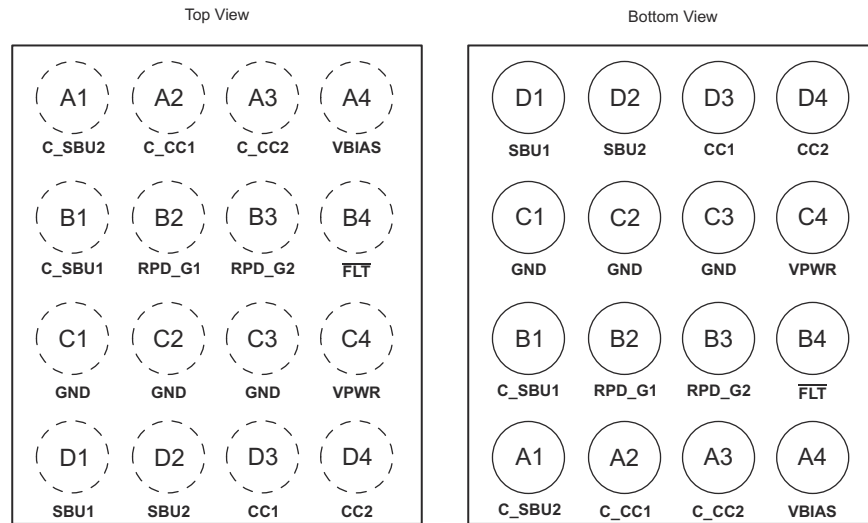
7 Specifications

7.1 Absolute Maximum Ratings

over operating free-air temperature range (unless otherwise noted)⁽¹⁾

			MIN	MAX	UNIT
V _I	Input voltage	VPWR	- 0.3	5	V
		RPD_G1, RPD_G2	- 0.3	24	V
V _O	Output voltage	FLT	- 0.3	6	V
		VBIAS	- 0.3	24	V
V _{IO}	I/O voltage	CC1, CC2, SBU1, SBU2	- 0.3	6	V
		C_CC1, C_CC2, C_SBU1, C_SBU2	- 0.3	24	V
I _O	Output Current	C_CC1, C_CC2 (TPD4S311)		950	mA
		C_CC1, C_CC2 (TPD4S311A)		1.2	A
T _A	Operating free air temperature		- 40	85	°C
T _{stg}	Storage temperature		- 65	150	°C

- (1) Stresses beyond those listed under *Absolute Maximum Ratings* may cause permanent damage to the device. These are stress ratings only, which do not imply functional operation of the device at these or any other conditions beyond those indicated under *Recommended Operating Conditions*. Exposure to absolute-maximum-rated conditions for extended periods may affect device reliability.

7.2 ESD Ratings—JEDEC Specification

			VALUE	UNIT
V _(ESD)	Electrostatic discharge	Human-body model (HBM), per ANSI/ESDA/JEDEC JS-001 ⁽¹⁾	±2000	V
		Charged-device model (CDM), per JEDEC specification JESD22-C101 ⁽²⁾	±500	

- (1) JEDEC document JEP155 states that 500-V HBM allows safe manufacturing with a standard ESD control process. Pins listed as ±2000 V may actually have higher performance.
- (2) JEDEC document JEP157 states that 250-V CDM allows safe manufacturing with a standard ESD control process. Pins listed as ±500 V may actually have higher performance.

7.3 ESD Ratings—IEC Specification

				VALUE	UNIT
V _(ESD)	Electrostatic discharge ⁽¹⁾	IEC 61000-4-2, C_CC1, C_CC2	Contact discharge	±8000	V
V _(ESD)	Electrostatic discharge ⁽¹⁾	IEC 61000-4-2, C_CC1, C_CC2	Air-gap discharge	±15000	V
V _(ESD)	Electrostatic discharge ⁽¹⁾	IEC 61000-4-2, C_SBU1, C_SBU2	Contact discharge	±6000	V
V _(ESD)	Electrostatic discharge ⁽¹⁾	IEC 61000-4-2, C_SBU1, C_SBU2	Air-gap discharge	±15000	V
V _(Surge)	Lightning and Surge	IEC 61000-4-5, C_CC1, C_CC2 (TPD4S311A)		±35	V
		IEC 61000-4-5, C_SBU1, C_SBU2 (TPD4S311A)		±30	V

- (1) Tested with connection to the TPS65982 EVM.

7.4 Recommended Operating Conditions

over operating free-air temperature range (unless otherwise noted)

			MIN	NOM	MAX	UNIT
V _I	Input voltage	VPWR	2.7	3.3	4.5	V
		RPD_G1, RPD_G2	0		5.5	V
V _O	Output voltage	FLT Pull-up resistor power rail	2.7		5.5	V
V _{IO}	I/O voltage	CC1, CC2, C_CC1, C_CC2	0		5.5	V
		SBU1, SBU2, C_SBU1, C_SBU2	0		4.3	V

7.4 Recommended Operating Conditions (continued)

over operating free-air temperature range (unless otherwise noted)

			MIN	NOM	MAX	UNIT
I _{VCONN}	V _{CONN} Current	Current flowing into CC1/2 and flowing out of C _{CC1/2} , 4.5 ≤ CCx ≤ 5.5, T _J ≤ 85 °C (TPD4S311)			400 ⁽¹⁾	mA
		Current flowing into CC1/2 and flowing out of C _{CC1/2} , 4.5 ≤ CCx ≤ 5.5, T _J ≤ 105 °C (TPD4S311A)			600	mA
		Current flowing into CC1/2 and flowing out of C _{CC1/2} , 4.5 ≤ CCx ≤ 5.5, T _J ≤ 70 °C (TPD4S311A)			1.2	A
External Components ⁽²⁾	FLT Pull-up resistance		1.7		300	kΩ
	VBIAS capacitance ⁽³⁾			0.1		μF
	VPWR Capacitance		0.3	1		μF

- (1) V_{conn} current loading beyond the values listed in *Recommended Operating Conditions* may degrade the operating lifetime of the device.
- (2) For recommended values for capacitors and resistors, the typical values assume a component placed on the board near the pin. Minimum and maximum values listed are inclusive of manufacturing tolerances, voltage derating, board capacitance, and temperature variation. The effective value presented should be within the minimum and maximums listed in the table.
- (3) The VBIAS pin requires a minimum 35-VDC rated capacitor. A 50-VDC rated capacitor is recommended to reduce capacitance derating. See the VBIAS Capacitor Selection section for more information on selecting the VBIAS capacitor.

7.5 Thermal Information

THERMAL METRIC ⁽¹⁾		TPD4S311	UNIT
		YBF DSBGA	
		16 PINS	
R _{θJA}	Junction-to-ambient thermal resistance	84.0	°C/W
R _{θJC(top)}	Junction-to-case (top) thermal resistance	0.5	°C/W
R _{θJB}	Junction-to-board thermal resistance	21.2	°C/W
ψ _{JT}	Junction-to-top characterization parameter	0.3	°C/W
ψ _{JB}	Junction-to-board characterization parameter	21.1	°C/W

- (1) For more information about traditional and new thermal metrics, see the [Semiconductor and IC Package Thermal Metrics](#) application report.

7.6 Electrical Characteristics

over operating free-air temperature range (unless otherwise noted)

PARAMETER	TEST CONDITIONS	MIN	TYP	MAX	UNIT		
CC OVP Switches							
R _{ON}	On Resistance of CC OVP FETs	CCx = 5.5 V, T _J ≤ 85 °C (TPD4S311)		378	550	mΩ	
		CCx = 5.5 V, T _J ≤ 85 °C (TPD4S311A)		232	405	mΩ	
C _{ON_CC}	Equivalent on Capacitance	45	74	120	pF		
RD_DB	Dead Battery Pull-Down Resistors (only present when device is unpowered)	V _{C_CCx} = 2.6 V		4.1	5.1	6.1	kΩ
VTH_DB	Threshold voltage of the pull-down FET in series with RD during dead battery	I _{C_CCx} = 80 μA		0.5	0.9	1.2	V
V _{OVPCC}	OVP Threshold on CC Pins	Place 5.5 V on C _{CCx} . Step up C _{CCx} until FLT pin is asserted. Put 100-mA load through the CC FET and see the FET shuts off.		5.75	6.0	6.2	V
V _{OVPCC_HYS}	Hysteresis on CC OVP	Place 6.5 V on C _{CCx} . Step down the voltage on C _{CCx} until the FLT pin is deasserted. Measure difference between rising and falling OVP threshold for C _{CCx} .			50		mV

7.6 Electrical Characteristics (continued)

over operating free-air temperature range (unless otherwise noted)

PARAMETER		TEST CONDITIONS	MIN	TYP	MAX	UNIT
BW _{ON}	On Bandwidth Single Ended (-3dB)	Measure the -3 dB bandwidth from C _{CCx} to CCx. Single ended measurement, 50-Ω system. V _{cm} = 0.1 V to 1.2 V.		100		MHz
V _{STBUS_CC}	Short-to-VBUS tolerance on the CC pins	Hot-Plug C _{CCx} with a 1 meter USB Type C Cable, place a 30-Ω load on CCx			24	V
V _{STBUS_CC_CLAMP}	Short-to-VBUS System-Side Clamping Voltage on the CC pins (CCx)	Hot-Plug C _{CCx} with a 1 meter USB Type C Cable. Hot-Plug voltage C _{CCx} = 24 V. VPWR = 3.3 V. Place a 30-Ω load on CCx.		8		V
SBU OVP Switches						
R _{ON}	On Resistance of SBU OVP FETs	SBU _x = 3.6 V. -40°C ≤ T _J ≤ +85°C		4	6.5	Ω
C _{ON_SBU}	Equivalent on Capacitance	Capacitance from SBU _x or C _{SBUx} to GND when device is powered. Measure at V _{C_SBUx} /V _{SBUx} = 0.3 V to 4.2 V.		6		pF
V _{OVPSBU}	OVP Threshold on SBU Pins	Place 3.6 V on C _{SBUx} . Step up C _{SBUx} until FLT pin is asserted.	4.35	4.5	4.7	V
V _{OVPSBU_HYS}	Hysteresis on SBU OVP	Place 5 V on C _{CCx} . Step down the voltage on C _{CCx} until the FLT pin is deasserted. Measure difference between rising and falling OVP threshold for C _{SBUx} .		50		mV
BW _{ON}	On Bandwidth Single Ended (-3dB)	Measure the -3 dB bandwidth from C _{SBUx} to SBU _x . Single ended measurement, 50-Ω system. V _{cm} = 0.1 V to 3.6 V.		900		MHz
X _{TALK}	Crosstalk	Measure crosstalk at f = 1 MHz from SBU1 to C _{SBU2} or SBU2 to C _{SBU1} . V _{cm1} = 3.6 V, V _{cm2} = 0.3 V. Terminate open sides to 50 Ω.		-70		dB
V _{STBUS_SBU}	Short-to-VBUS tolerance on the SBU pins	Hot-Plug C _{SBUx} with a 1 meter USB Type C Cable. Put a 100-nF capacitor in series with a 40-Ω resistor to GND on SBU _x .			24	V
V _{STBUS_SBU_CLAMP}	Short-to-VBUS System-Side Clamping Voltage on the SBU pins (SBU _x)	Hot-Plug C _{SBUx} with a 1 meter USB Type C Cable. Hot-Plug voltage C _{SBUx} = 24 V. VPWR = 3.3 V. Put a 150-nF capacitor in series with a 40-Ω resistor to GND on SBU _x .		8		V
Power Supply and Leakage Currents						
V _{PWR_UVLO}	V _{PWR} Under Voltage Lockout	Place 1 V on VPWR and raise voltage until SBU or CC FETs turn-on.	2.1	2.3	2.5	V
V _{PWR_UVLO_HYS}	V _{PWR} UVLO Hysteresis	Place 3 V on VPWR and lower voltage until SBU or CC FETs turnoff; measure difference between rising and falling UVLO to calculate hysteresis.	100	150	200	mV
I _{VPWR}	V _{PWR} supply current	VPWR = 3.3 V (typical), VPWR = 4.5 V (maximum). -40°C ≤ T _J ≤ +85°C.		90	135	μA
I _{C_CC_LEAK}	Leakage current for C _{CCx} pins when device is powered	VPWR = 3.3 V, V _{C_CCx} = 3.6 V, CCx pins are floating, measure leakage current into C _{CCx} pins.			5	μA
I _{C_SBU_LEAK}	Leakage current for C _{SBUx} pins when device is powered	VPWR = 3.3 V, V _{C_SBUx} = 3.6 V, SBU _x pins are floating, measure leakage current into C _{SBUx} pins. Result should be same if SBU _x side is biased and C _{SBUx} is left floating. -40°C ≤ T _J ≤ +85°C			3	μA
I _{C_CC_LEAK_OVP}	Leakage current for C _{CCx} pins when device is in OVP	VPWR = 0 V or 3.3 V, V _{C_CCx} = 24 V, CCx pins are set to 0 V, measure leakage current into C _{CCx} pins.			1200	μA

7.6 Electrical Characteristics (continued)

over operating free-air temperature range (unless otherwise noted)

PARAMETER		TEST CONDITIONS	MIN	TYP	MAX	UNIT
$I_{C_SBU_LEAK_OVP}$	Leakage current for C_SBUx pins when device is in OVP	VPWR = 0 V or 3.3 V, $V_{C_SBUx} = 24$ V, SBUx pins are set to 0 V, measure leakage current into C_SBUx pins.			400	μ A
$I_{CC_LEAK_OVP}$	Leakage current for CC pins when device is in OVP	VPWR = 0 V or 3.3 V, $V_{C_CCx} = 24$ V, CCx pins are set to 0 V, measure leakage current out of CCx pins.			30	μ A
$I_{SBU_LEAK_OVP}$	Leakage current for SBU pins when device is in OVP	VPWR = 0 V, $V_{C_SBUx} = 24$ V, SBUx pins are set to 0 V, measure leakage current into SBUx pins.	-1		1	μ A
/FLT Pin						
V_{OL}	Low-level output voltage	IOL = 3 mA. Measure voltage at FLT pin.			0.4	V
Over Temperature Protection						
T_{SD_RISING}	The rising over-temperature protection shutdown threshold		150	175		$^{\circ}$ C
$T_{SD_FALLING}$	The falling over-temperature protection shutdown threshold		130	140		$^{\circ}$ C
T_{SD_HYST}	The over-temperature protection shutdown threshold hysteresis			35		$^{\circ}$ C

7.7 Timing Requirements

		MIN	NOM	MAX	UNIT
Power-On and Off Timings					
t_{ON_FET}	Time from Crossing Rising VPWR UVLO until CC and SBU OVP FETs are on.		1.3	3.5	ms
$t_{ON_FET_DB}$	Time from Crossing Rising VPWR UVLO until CC and SBU OVP FETs are on and the dead battery resistors are off.		5.7	9.5	ms
dV_{PWR_OFF}/dt	Minimum slew rate allowed to guarantee CC and FETs turn off during a power off.	-0.5			V/ μ s
Over Voltage Protection					
$t_{OVP_RESPONSE_CC}$	OVP response time on the CCx pins. Time from OVP asserted until OVP FETs turn off.		70		ns
$t_{OVP_RESPONSE_SBU}$	OVP response time on the SBUx pins. Time from OVP asserted until OVP FETs turn off.		80		ns
$t_{OVP_RECOVERY_CC}$	OVP recovery time on the CCx pins. Once an OVP has occurred, the minimum time duration until the CC FETs turn back on. OVP must be removed for CC FETs to turn back on.		0.93		ms
$t_{OVP_RECOVERY_CC_DB}$	OVP recovery time on the CCx pins. Once an OVP has occurred, the minimum time duration until the CC FETs turn back on and the dead battery resistors turn off. OVP must be removed for CC FETs to turn back on.		5		ms
$t_{OVP_RECOVERY_SBU}$	OVP recovery time on the SBUx pins. Once an OVP has occurred, the minimum time duration until the SBU FETs turn back on. OVP must be removed for SBU FETs to turn back on.		0.62		ms
$t_{OVP_FLT_ASSERTION}$	Time from OVP Asserted to /FLT assertion. FLT assertion is 10% of the maximum value. Set C_CCx or C_SBUx above the maximum OVP threshold. Start the time where it passes the typical OVP threshold value.		20		μ s
$t_{OVP_FLT_DEASSERTION}$	Time from CC FET turn on after an OVP to FLT deassertion.		5		ms

7.8 Typical Characteristics



图 7-1. SBU Bandwidth



图 7-2. SBU Crosstalk

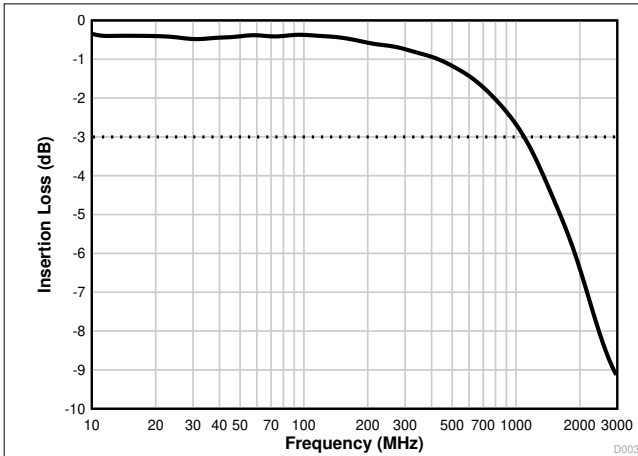

图 7-3. SBU Short-to- V_{BUS} 24 V Zoomed In

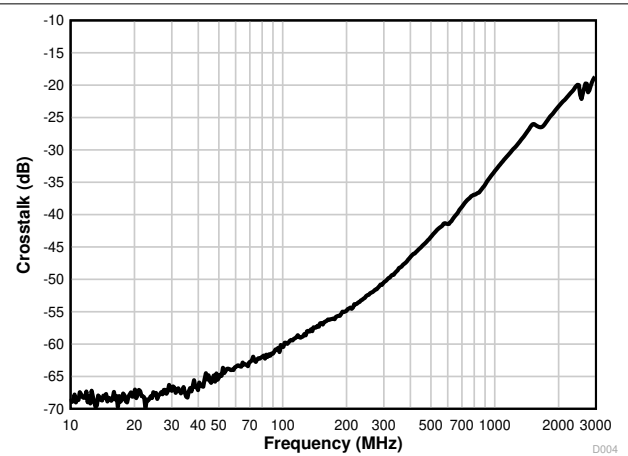

图 7-4. SBU Short-to- V_{BUS} 24 V Zoomed Out

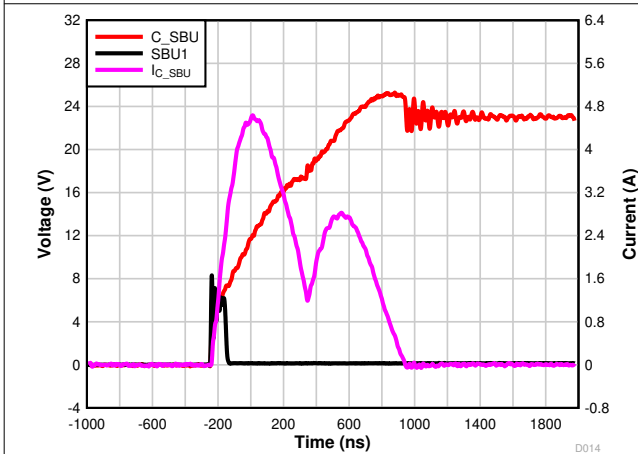

图 7-5. SBU Short-to- V_{BUS} 5 V Zoomed In

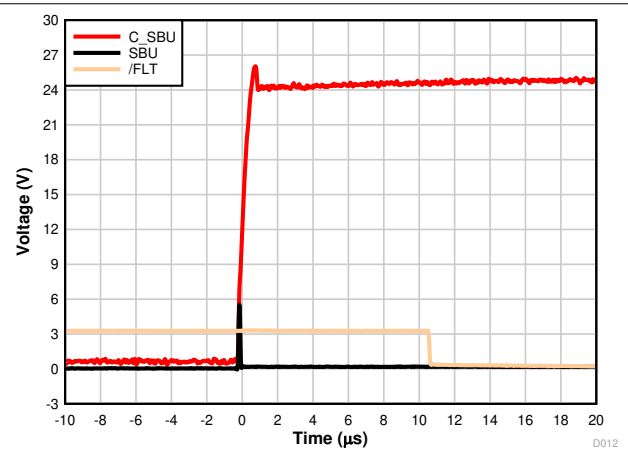

图 7-6. SBU Short-to- V_{BUS} 5 V Zoomed Out

7.8 Typical Characteristics (continued)

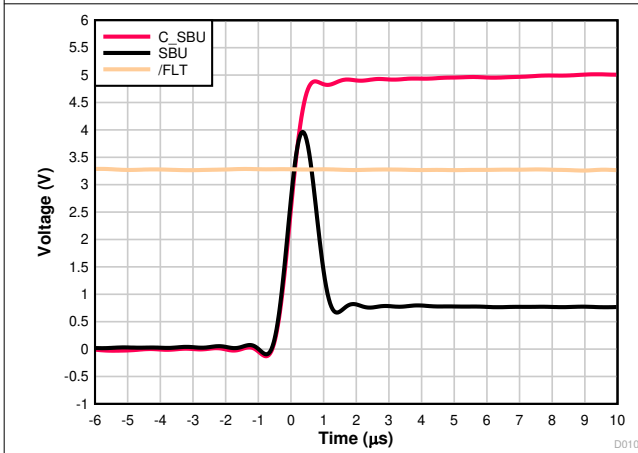

图 7-7. SBU R_{ON} Flatness

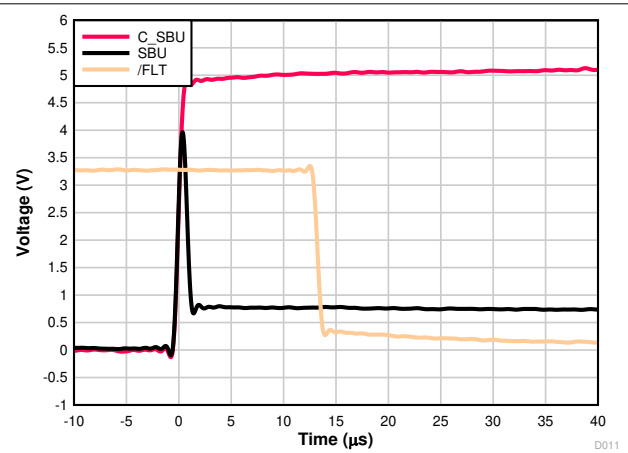

图 7-8. SBU IEC 61000-4-2 4-kV Response Waveform

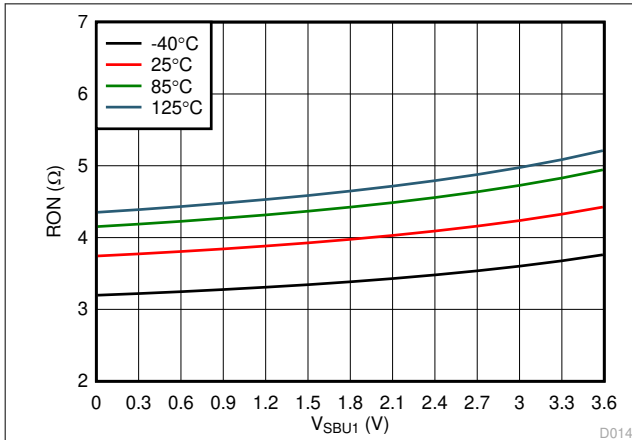

图 7-9. SBU IEC 61000-4-2 -4-kV Response Waveform

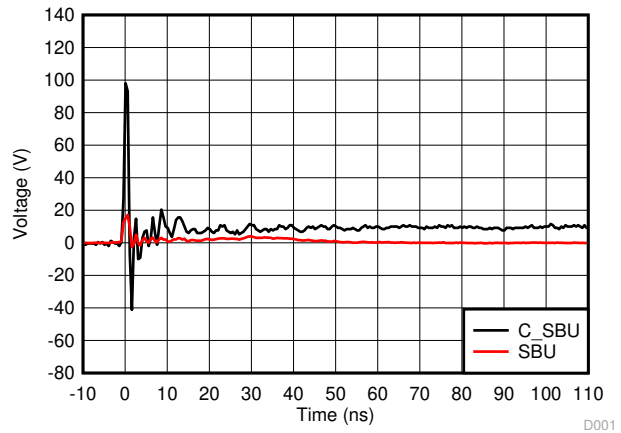

图 7-10. SBU Path Leakage Current vs Ambient Temperature at 3.6 V

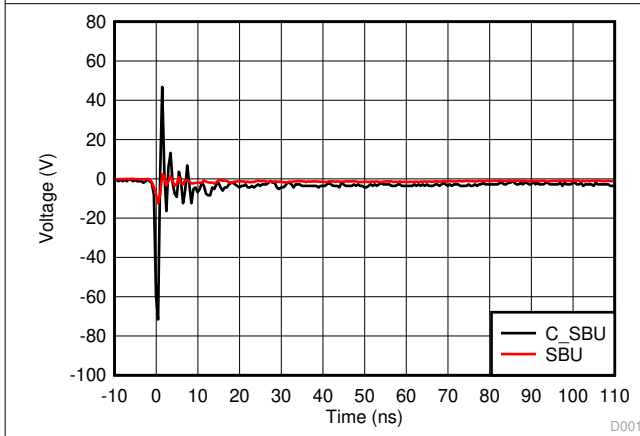

图 7-11. C_SBU OVP Leakage Current vs Ambient Temperature at 5.5 V and 24 V

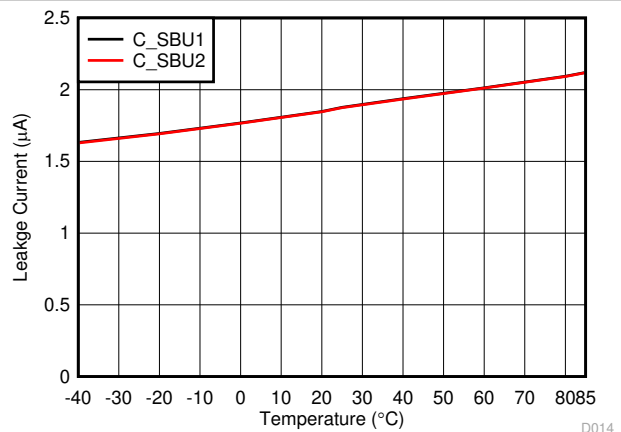

图 7-12. SBU OVP Leakage Current vs Ambient Temperature at 5.5 V and 24 V

7.8 Typical Characteristics (continued)

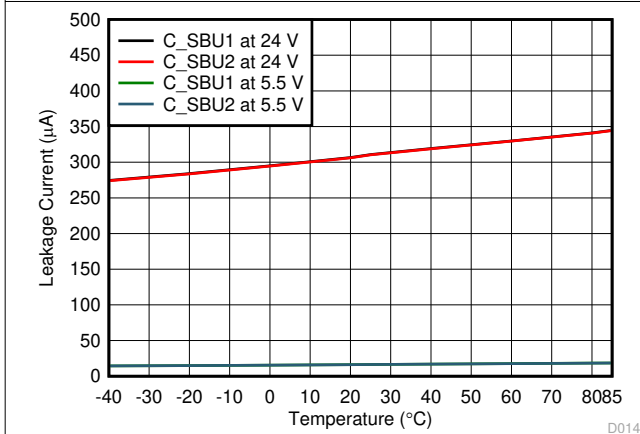

图 7-13. SBU FET Turnon Timing

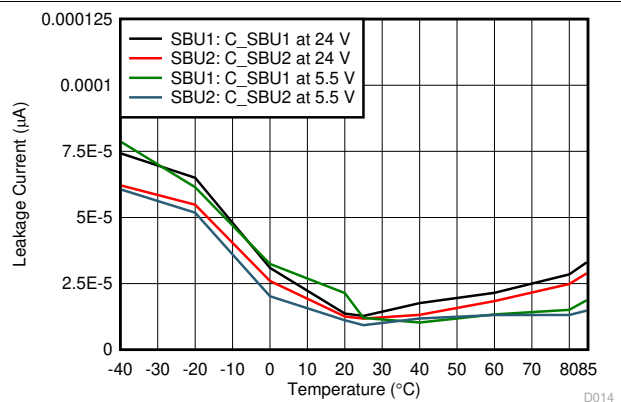
D014

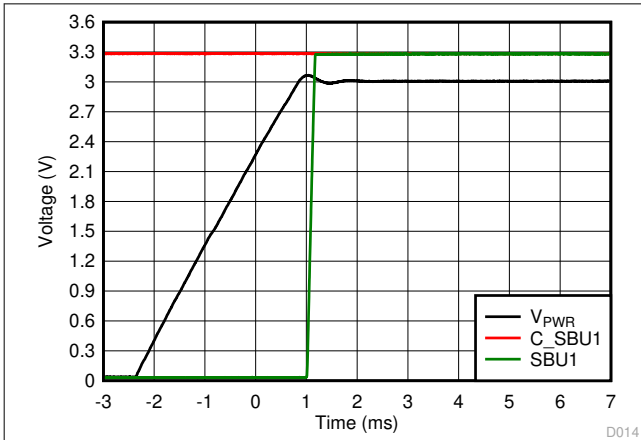

图 7-14. C_SBU TLP Curve Unpowered

D005

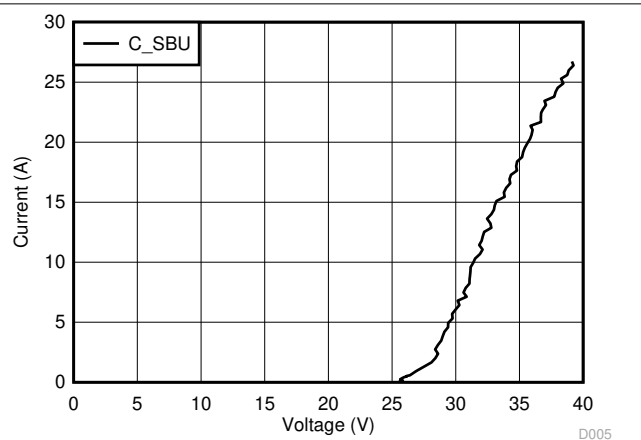

图 7-15. SBU IV Curve

D003

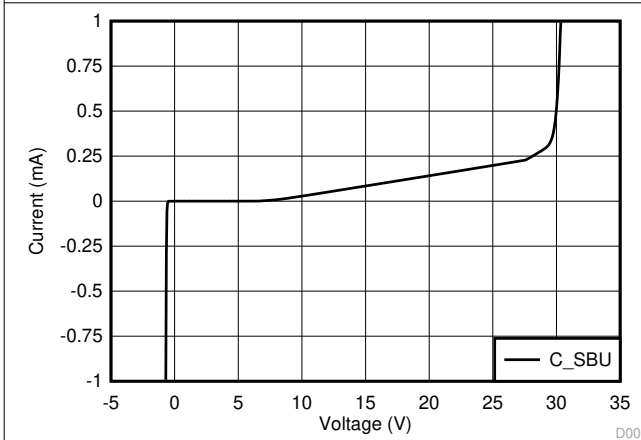

图 7-16. CC Bandwidth

D001



图 7-17. CC Short-to-V_{BUS} 24 V Zoomed In

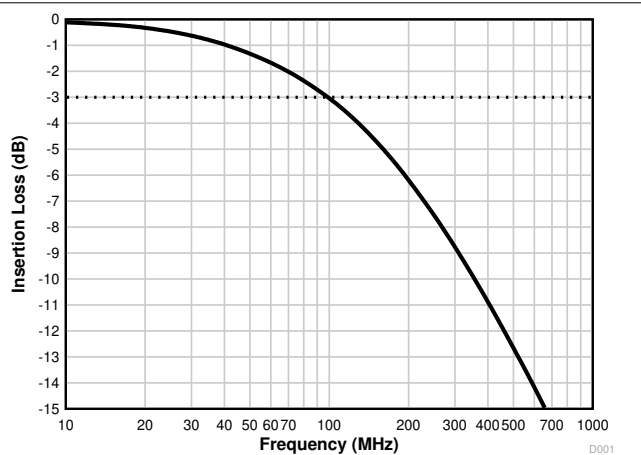

图 7-18. CC Short-to-V_{BUS} 24 V Zoomed Out

7.8 Typical Characteristics (continued)

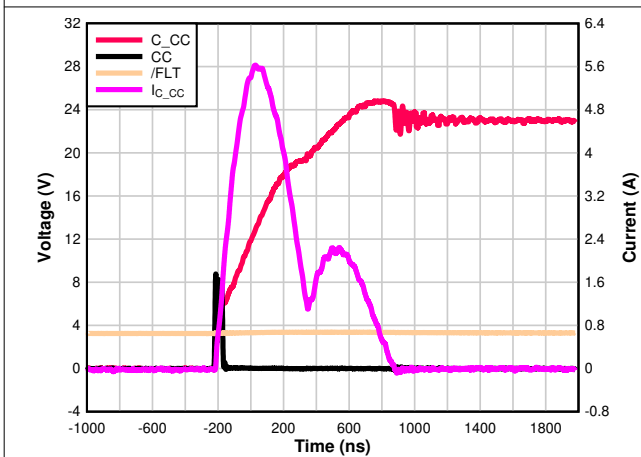

图 7-19. CC Short-to- V_{BUS} 5 V Zoomed In

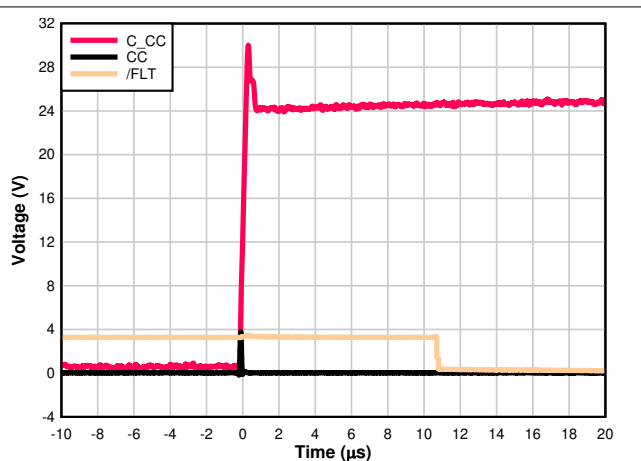

图 7-20. CC Short-to- V_{BUS} 5 V Zoomed Out

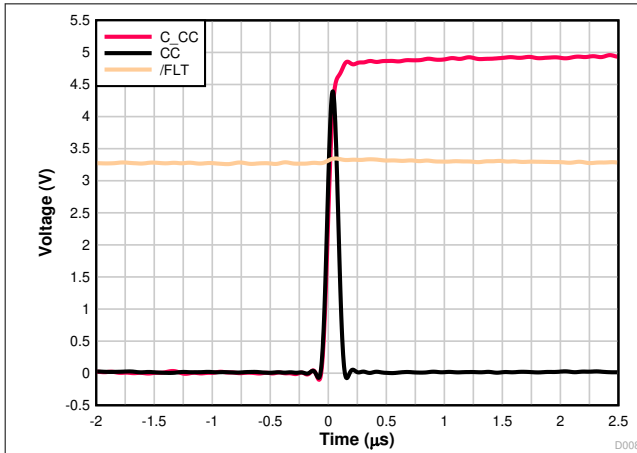

图 7-21. CC R_{ON} Versus Temperature

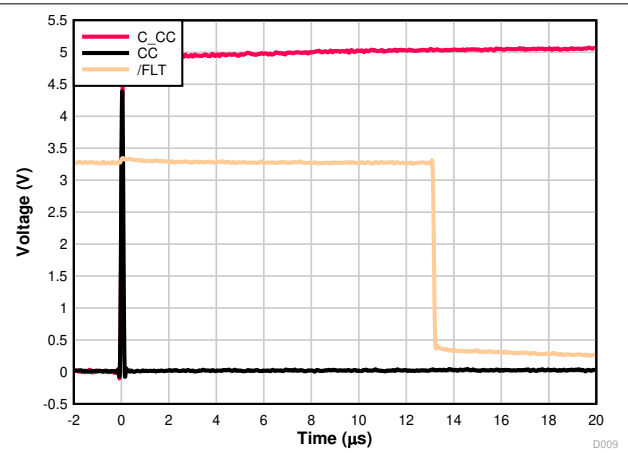

图 7-22. CC IEC 61000-4-2 8-kV Response Waveform

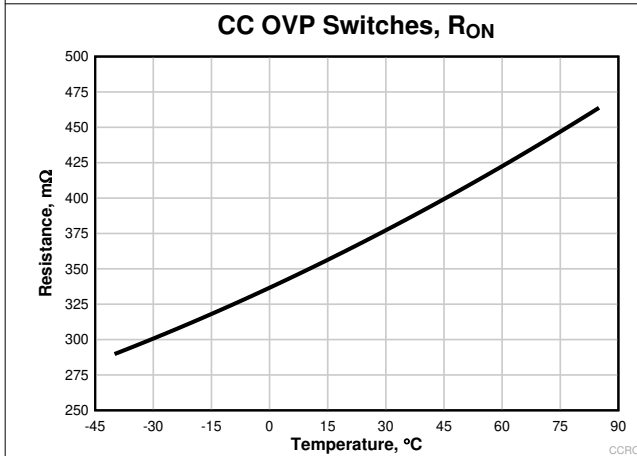

图 7-23. CC IEC 61000-4-2 -8-kV Response Waveform

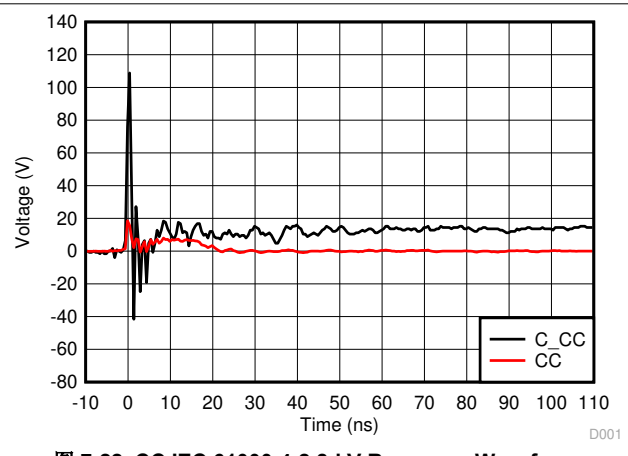

图 7-24. C_{CC} Path Leakage Current vs Ambient Temperature at $C_{CC} = 5.5 V$

7.8 Typical Characteristics (continued)

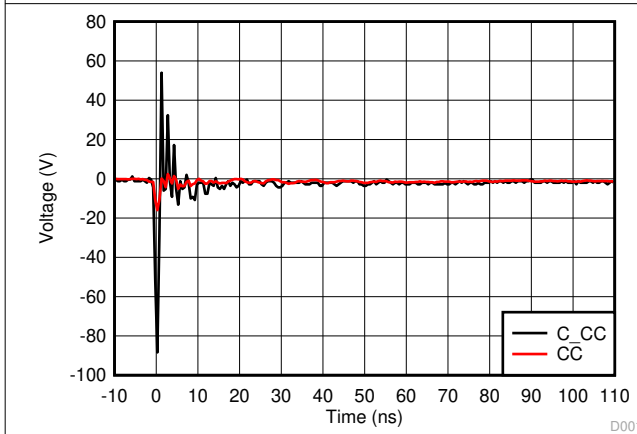

图 7-25. C_{CC} OVP Leakage Current vs Ambient Temperature at C_{CC} = 24 V

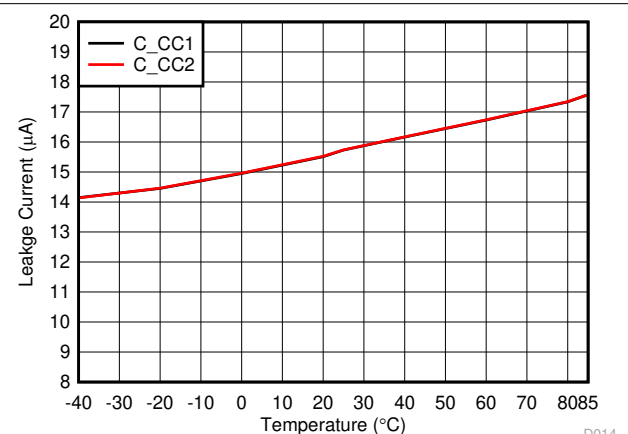

图 7-26. CC OVP Leakage Current vs Ambient Temperature at C_{CC} = 24 V

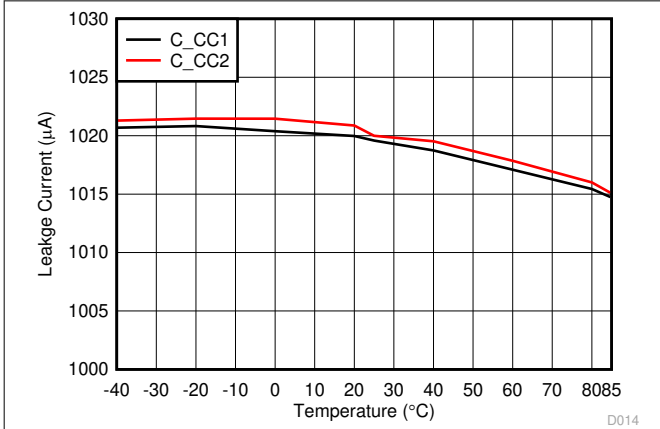

图 7-27. CC FET Turnon Timing

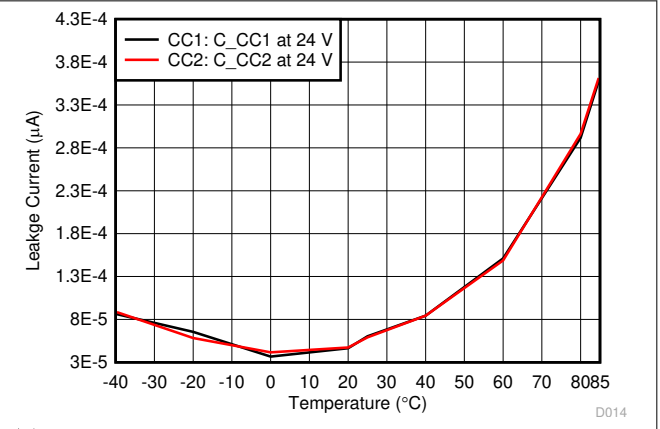

图 7-28. C_{CC} TLP Curve Unpowered

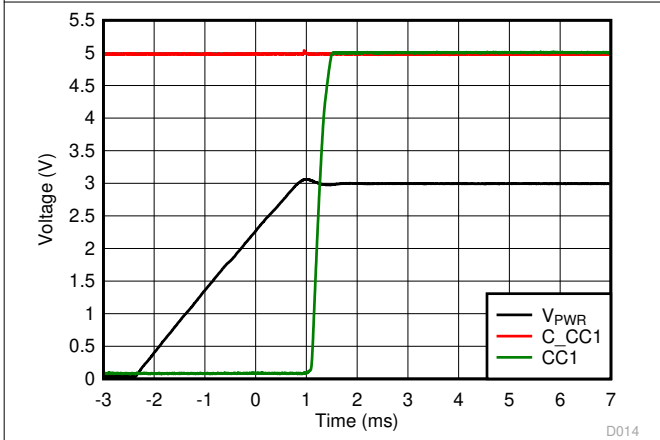

图 7-29. C_{CC} IV Curve

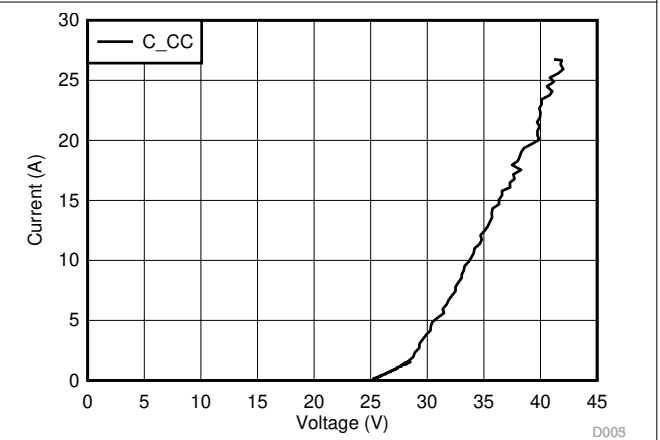

图 7-30. V_{PWR} Supply Leakage vs Ambient Temperature at 3.6 V

8 Detailed Description

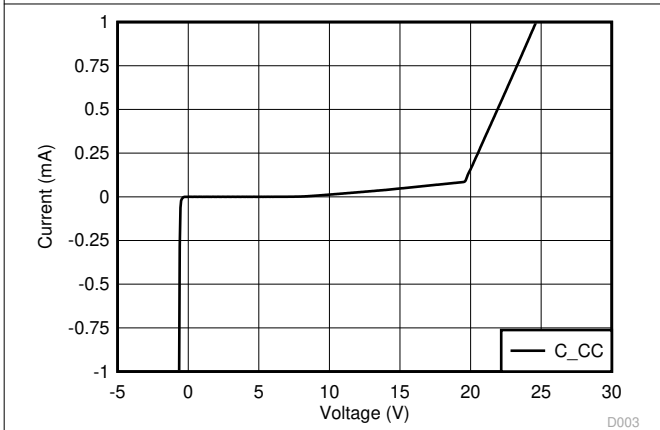
8.1 Overview

The TPD4S311 is a single chip USB Type-C port protection solution that provides 20-V Short-to- V_{BUS} overvoltage and IEC ESD protection. Due to the small pin pitch of the USB Type-C connector and non-compliant USB Type-C cables and accessories, the V_{BUS} pins can get shorted to the CC and SBU pins inside the USB Type-C connector. Because of this short-to- V_{BUS} event, the CC and SBU pins need to be 20-V tolerant, to support protection on the full USB PD voltage range. Even if a device does not support 20-V operation on V_{BUS} , non-compliant adaptors can start out with 20-V V_{BUS} condition, making it necessary for any USB Type-C device to support 20 V protection. The TPD4S311 integrates four channels of 20-V Short-to- V_{BUS} overvoltage protection for the CC1, CC2, SBU1, and SBU2 pins of the USB Type-C connector.

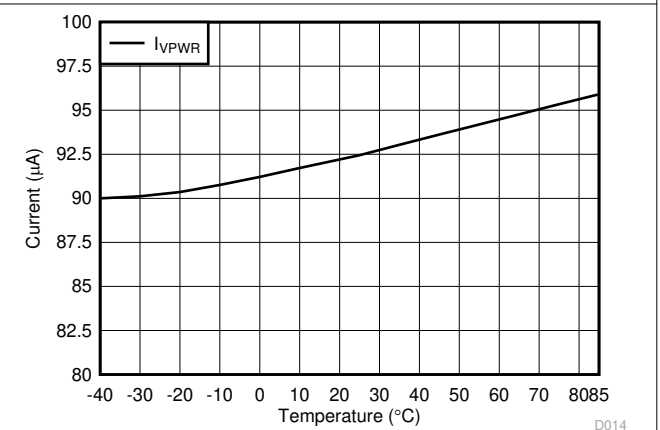
Additionally, IEC 61000-4-2 system level ESD protection is required in order to protect a USB Type-C port from ESD strikes generated by end product users. The TPD4S311 integrates four channels of IEC61000-4-2 ESD protection for the CC1, CC2, SBU1, and SBU2 pins of the USB Type-C connector. This means IEC ESD protection is provided for all of the low-speed pins on the USB Type-C connector in a single chip in the TPD4S311. Additionally, high-voltage IEC ESD protection that is 22-V DC tolerant is required for the CC and SBU lines in order to simultaneously support IEC ESD and Short-to- V_{BUS} protection; there are not many discrete market solutions that can provide this kind of protection. This high-voltage IEC ESD diode is what the TPD4S311 integrates, specifically designed to guarantee it works in conjunction with the overvoltage protection FETs inside the device. This sort of solution is very hard to generate with discrete components.

8.2 Functional Block Diagram

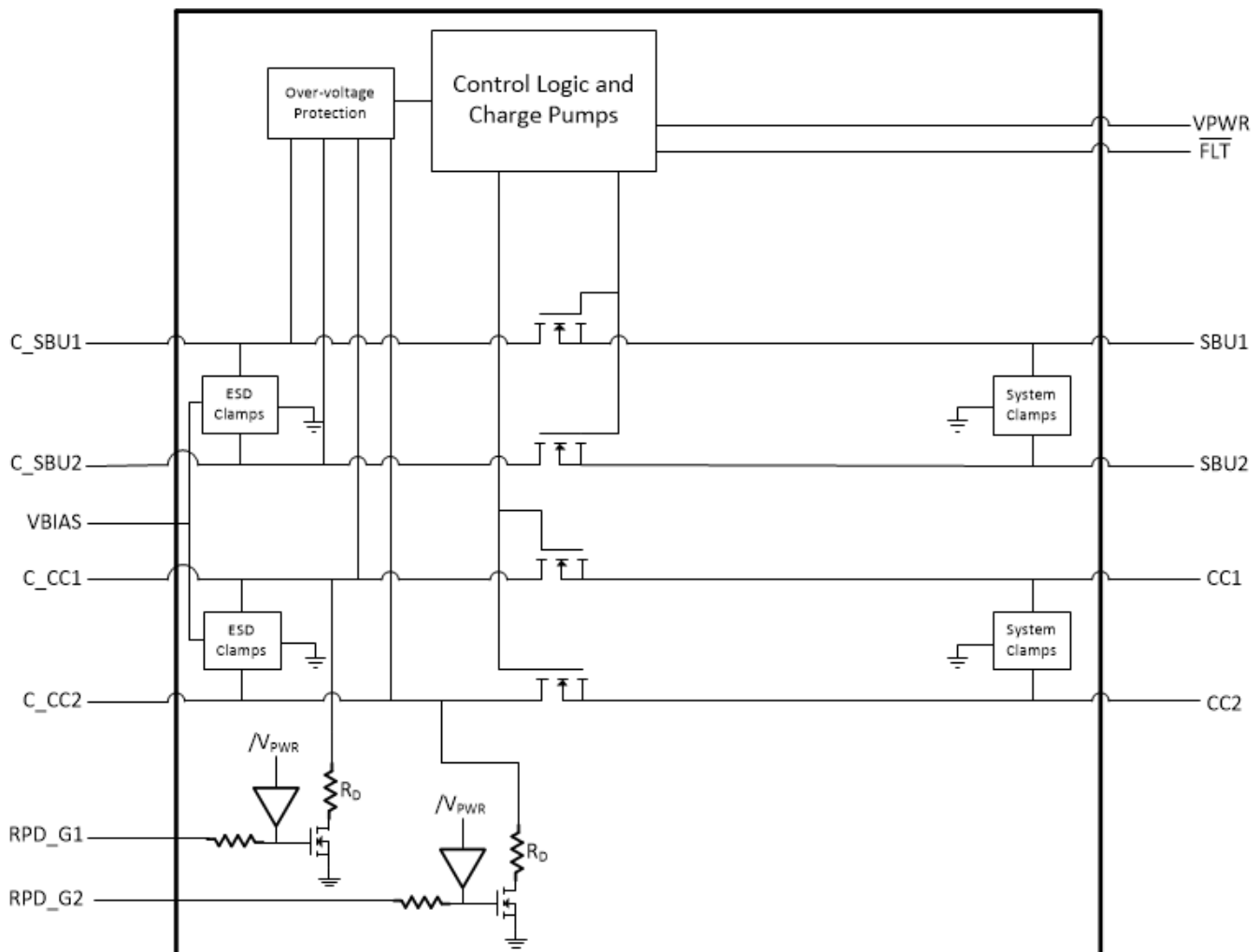

8.3 Feature Description

8.3.1 4-Channels of Short-to- V_{BUS} Overvoltage Protection (CC1, CC2, SBU1, SBU2 Pins): 24- V_{DC} Tolerant

The TPD4S311 provides 4-channels of Short-to- V_{BUS} Overvoltage Protection for the CC1, CC2, SBU1, and SBU2 pins of the USB Type-C connector. The TPD4S311 is able to handle 24- V_{DC} on its C_CC1, C_CC2, C_SBU1, and C_SBU2 pins. This is necessary because according to the USB PD specification, with V_{BUS} set for 20-V operation, the V_{BUS} voltage is allowed to legally swing up to 21 V and 21.5 V on voltage transitions from a different USB PD V_{BUS} voltage. The TPD4S311 builds in tolerance up to 24- V_{BUS} to provide margin above this 21.5-V specification to be able to support USB PD adaptors that may break the USB PD specification.

When a short-to- V_{BUS} event occurs, ringing happens due to the RLC elements in the hot-plug event. With very low resistance in this RLC circuit, ringing up to twice the settling voltage can appear on the connector. More than 2x ringing can be generated if any capacitor on the line derates in capacitance value during the short-to- V_{BUS} event. This means that more than 44 V could be seen on a USB Type-C pin during a Short-to- V_{BUS} event. The TPD4S311 has built in circuit protection to handle this ringing. The diode clamps used for IEC ESD protection also clamp the ringing voltage during the short-to- V_{BUS} event to limit the peak ringing to approximately 30 V. Additionally, the overvoltage protection FETs integrated inside the TPD4S311 are 30-V tolerant, therefore being capable of supporting the high-voltage ringing waveform that is experienced during the short-to- V_{BUS} event. The well designed combination of voltage clamps and 30-V tolerant OVP FETs insures the TPD4S311 can handle Short-to- V_{BUS} hot-plug events with hot-plug voltages as high as 24- V_{DC} .

The TPD4S311 has an extremely fast turnoff time of 70 ns typical. Furthermore, additional voltage clamps are placed after the OVP FET on the system side (CC1, CC2, SBU1, SBU2) pins of the TPD4S311, to further limit the voltage and current that are exposed to the USB Type-C CC/PD controller during the 70 ns interval while the OVP FET is turning off. The combination of connector side voltage clamps, OVP FETs with extremely fast turnoff time, and system side voltage clamps all work together to insure the level of stress seen on a CC1, CC2, SBU1, or SBU2 pin during a short-to- V_{BUS} event is less than or equal to an HBM event. This is done by design, as any USB Type-C CC/PD controller will have built in HBM ESD protection.

图 8-1 is an example of the TPD4S311 successfully protecting the TPS65982, the world's first fully integrated, full-featured USB Type-C and PD controller.



图 8-1. TPD4S311 Protecting the TPS65982 During a Short-to- V_{BUS} Event

8.3.2 4-Channels of IEC 61000-4-2 ESD Protection (CC1, CC2, SBU1, SBU2 Pins)

The TPD4S311 integrates 4-Channels of IEC 61000-4-2 system level ESD protection for the CC1, CC2, SBU1, and SBU2 pins. USB Type-C ports on end-products need system level IEC ESD protection in order to provide adequate protection for the ESD events that the connector can be exposed to from end users. The TPD4S311 integrates IEC ESD protection for all of the low-speed pins on the USB Type-C connector in a single chip. Also note, that while the RPD_Gx pins are not individually rated for IEC ESD, when they are shorted to the C_CCx

pins, the C_CCx pins provide protection for both the C_CCx pins and the RPD_Gx pins. Additionally, high-voltage IEC ESD protection that is 24-V DC tolerant is required for the CC and SBU lines in order to simultaneously support IEC ESD and Short-to- V_{BUS} protection; there are not many discrete market solutions that can provide this kind of protection. The TPD4S311 integrates this type of high-voltage ESD protection so a system designer can meet both IEC ESD and Short-to- V_{BUS} protection requirements in a single device.

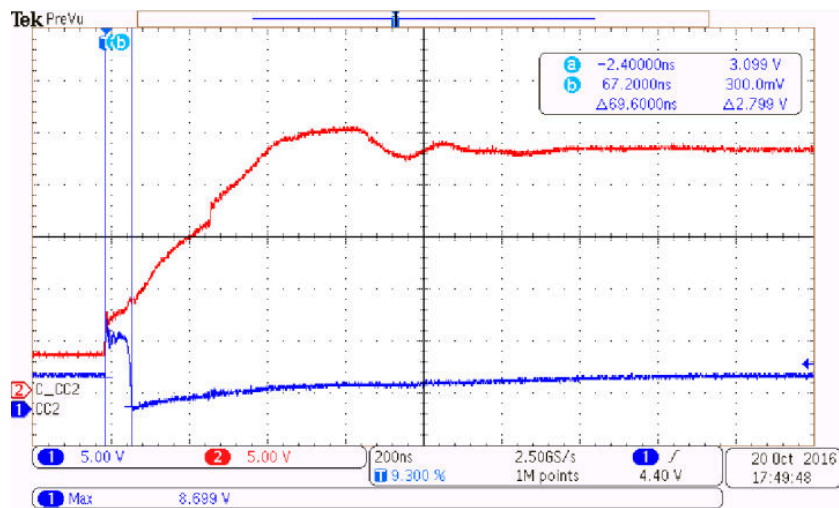
8.3.3 CC1, CC2 Overvoltage Protection FETs 400-mA or 600-mA Capable for Passing VCONN Power

The CC pins on the USB Type-C connector serve many functions; one of the functions is to be a provider of power to active cables. Active cables are required when desiring to pass greater than 3 A of current on the V_{BUS} line or when the USB Type-C port uses the super-speed lines (TX1+, TX2 -, RX1+, RX1 -, TX2+, TX2 -, RX2+, RX2 -). When CC is configured to provide power, it is called VCONN. VCONN is a DC voltage source in the range of 3 V to 5.5 V. If supporting VCONN, a VCONN provider must be able to provide 1 W of power to a cable; this translates into a current range of 200 mA to 333 mA (depending on your VCONN voltage level). Additionally, if operating in a USB PD alternate mode, greater power levels are allowed on the VCONN line.

When a USB Type-C port is configured for VCONN and using the TPD4S311, this VCONN current flows through the OVP FETs of the TPD4S311. Therefore, the TPD4S311 has been designed to handle these currents and have an RON low enough to provide a specification compliant VCONN voltage to the active cable. The TPD4S311 is designed to handle up to 400 mA, while the TPD4S311A is designed to handle up to 600 mA of DC current to allow for alternate mode support in addition to the standard 1 W required by the USB Type-C specification.

8.3.4 CC Dead Battery Resistors Integrated for Handling the Dead Battery Use Case in Mobile Devices

An important feature of USB Type-C and USB PD is the ability for this connector to serve as the sole power source to mobile devices. With support up to 100 W, the USB Type-C connector supporting USB PD can be used to power a whole new range of mobile devices not previously possible with legacy USB connectors.

When the USB Type-C connector is the sole power supply for a battery powered device, the device must be able to charge from the USB Type-C connector even when its battery is dead. In order for a USB Type-C power adaptor to supply power on V_{BUS} , RD pulldown resistors must be exposed on the CC pins. These RD resistors are typically included inside a USB Type-C CC/PD controller. However, when the TPD4S311 is used to protect the USB Type-C port, the OVP FETs inside the device isolate these RD resistors in the CC/PD controller when the mobile device has no power. This is because when the TPD4S311 has no power, the OVP FETs are turned off to guarantee overvoltage protection in a dead battery condition. Therefore, the TPD4S311 integrates high-voltage, dead battery RD pull-down resistors to allow dead battery charging simultaneously with high-voltage OVP protection.

If dead battery support is required, short the RPD_G1 pin to the C_CC1 pin, and short the RPD_G2 pin to the C_CC2 pin. This connects the dead battery resistors to the connector CC pins. When the TPD4S311 is unpowered, and the RP pull-up resistor is connected from a power adaptor, this RP pull-up resistor activates the RD resistor inside the TPD4S311. This enables V_{BUS} to be applied from the power adaptor even in a dead battery condition. Once power is restored back to the system and back to the TPD4S311 on its VPWR pin, the TPD4S311 turns ON its OVP FETs in 3.5 ms and then turns OFF its dead battery RD. The TPD4S311 first turns ON its CC OVP FETs fully, and then removes its dead battery RDs. This is to make sure the PD controller RD is fully exposed before removing the RD of the TPD4S311. This is to help ensure the USB Type-C source remains attached because a USB Type-C sink must have an RD present on CC at all times to guarantee according to the USB Type-C spec that the USB Type-C source remains attached.

If desiring to power the CC/PD controller during dead battery mode and if the CC/PD Controller is configured as a DRP, it is critical that the TPD4S311 be powered before or at the same time that the CC/PD controller is powered. It is also critical that when unpowered, the CC/PD controller also expose its dead battery resistors. When the TPD4S311 gets powered, it exposes the CC pins of the CC/PD controller within 3.5 ms, and then removes its own RD dead battery resistors. Once the TPD4S311 turns on, the RD pull-down resistors of the CC/PD controller must be present immediately, in order to guarantee the power adaptor connected to power the dead battery device keeps its V_{BUS} turned on. If the power adaptor does not see RD present, it can disconnect V_{BUS} . This removes power from the device with its battery still not sufficiently charged, which consequently removes power from the CC/PD controller and the TPD4S311. Then the RD resistors of the TPD4S311 are

exposed again, and connects the power adaptor's V_{BUS} to start the cycle over. This creates an infinite loop, never or very slowly charging the mobile device.

If the CC/PD Controller is configured for DRP and has started its DRP toggle before the TPD4S311 turns on, this DRP toggle is unable to guarantee that the power adaptor does not disconnect from the port. Therefore, it is recommended if the CC/PD controller is configured for DRP, that its dead battery resistors be exposed as well, and that they remain exposed until the TPD4S311 turns on. This is typically accomplished by powering the TPD4S311 at the same time as the CC/PD controller when powering the CC/PD controller in dead battery operation. When protecting the TPS6598x family of PD controllers with TPD4S311, this is accomplished by powering TPD4S311 from TPS6598x's LDO_3V3 pin (connect TPS6598x's LDO_3V3 pin to TPD4S311's V_{PWR} pin).

If dead battery charging is not required in your application, connect the RPD_G1 and RPD_G2 pins to ground.

8.3.5 1.69-mm × 1.69-mm DSBGA Package

The TPD4S311 comes in a tiny, 1.69-mm × 1.69-mm DSBGA package, greatly reducing the size of implementing a similar protection solution discretely. The DSBGA package supports a wide range of PCB designs.

8.4 Device Functional Modes

表 8-1 describes all of the functional modes for the TPD4S311. The "X" in the below table are "do not care" conditions, meaning any value can be present within the absolute maximum ratings of the datasheet and maintain that functional mode.

表 8-1. Device Mode Table

Device Mode Table		Inputs					Outputs		
MODE		VPWR	C_CCx	C_SBUx	RPD_Gx	T _J	FLT	CC FETs	SBU FETs
Normal Operating Conditions	Unpowered, no dead battery support	<UVLO	X	X	Grounded	X	High-Z	OFF	OFF
	Unpowered, dead battery support	<UVLO	X	X	Shorted to C_CCx	X	High-Z	OFF	OFF
	Powered on	>UVLO	<OVP	<OVP	X, forced OFF	<TSD	High-Z	ON	ON
Fault Conditions	Thermal shutdown	>UVLO	X	X	X, forced OFF	>TSD	Low (Fault Asserted)	OFF	OFF
	CC over voltage condition	>UVLO	>OVP	X	X, forced OFF	<TSD	Low (Fault Asserted)	OFF	OFF
	SBU over voltage condition	>UVLO	X	>OVP	X, forced OFF	<TSD	Low (Fault Asserted)	OFF	OFF
	IEC ESD generated over voltage condition ⁽¹⁾	>UVLO	X	X	R _D ON if RPD_Gx is shorted to C_CCx	<TSD	Low (Fault Asserted)	OFF	OFF

(1) This row describes the state of the device while still in OVP after the IEC ESD strike which put the device into OVP is over, and the voltages on the C_CCx and C_SBUx pins have returned to their normal voltage levels.

9 Application and Implementation

Note

以下应用部分中的信息不属于 TI 器件规格的范围，TI 不担保其准确性和完整性。TI 的客户应负责确定器件是否适用于其应用。客户应验证并测试其设计，以确保系统功能。

9.1 Application Information

The TPD4S311 provides 4-channels of Short-to-V_{BUS} overvoltage protection for the CC1, CC2, SBU1, and SBU2 pins of the USB Type-C connector, and 4-channels of IEC ESD protection for the CC1, CC2, SBU1, and SBU2 pins of the USB Type-C connector. Care must be taken to insure that the TPD4S311 provides adequate system protection as well as insuring that proper system operation is maintained. The following application example explains how to properly design the TPD4S311 into a USB Type-C system.

9.2 Typical Application



图 9-1. TPD4S311 Typical Application Diagram



图 9-2. TPD4S311 Reference Schematic

9.2.1 Design Requirements

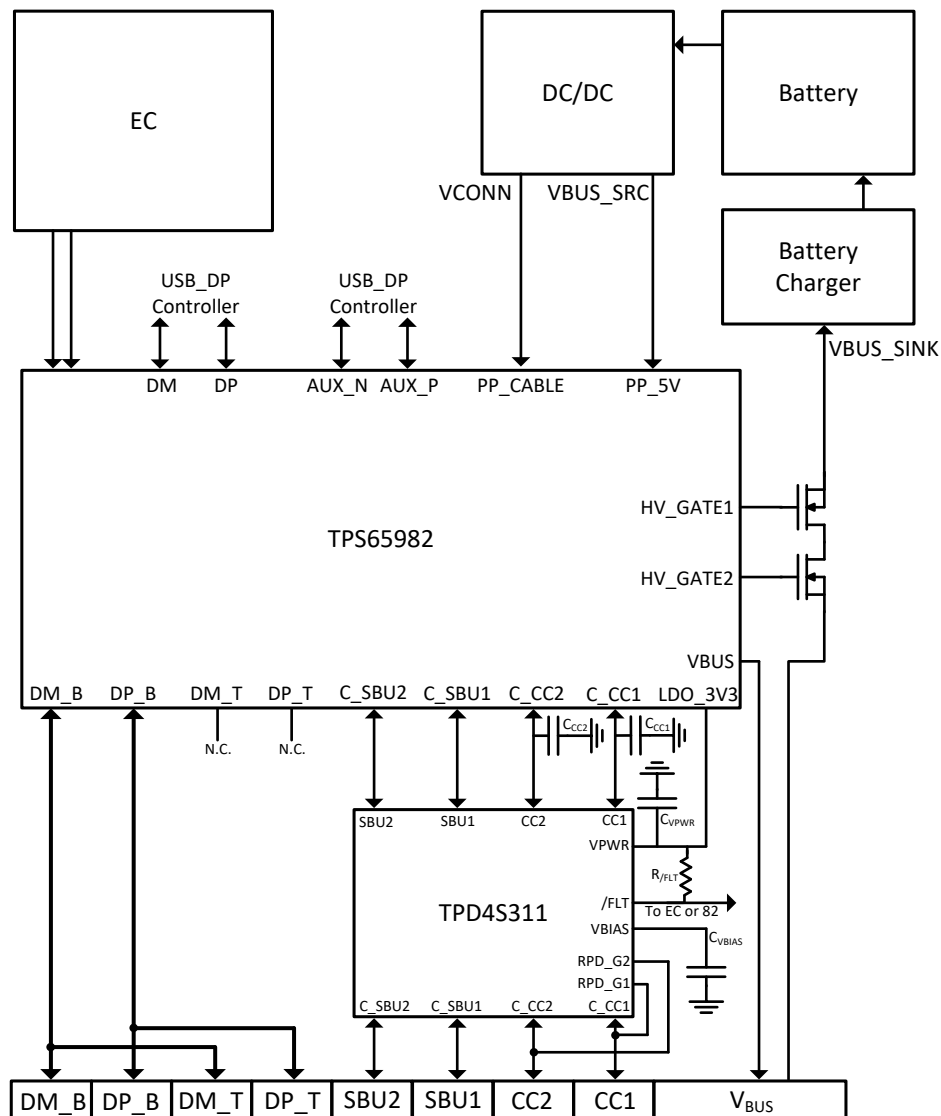
In this application example we study the protection requirements for a full-featured USB Type-C DRP Port, fully equipped with USB-PD, USB2.0, USB3.0, Display Port, and 100 W charging. The [TPS65982](#) is used to easily enable a full-featured port with a single chip solution. In this application, all the pins of the USB Type-C connector are used. Both the CC and SBU pins are susceptible to shorting to the V_{BUS} pin. With 100 W charging, V_{BUS} operates at 20 V, requiring the CC and SBU pins to tolerate $20-V_{DC}$. With these protection requirements present for the USB Type-C connector, the TPD4S311 is used. The TPD4S311 is a single chip solution that provides all the required protection for the SBU and CC pins in the USB Type-C connector.

表 9-1 lists the TPD4S311 design parameters.

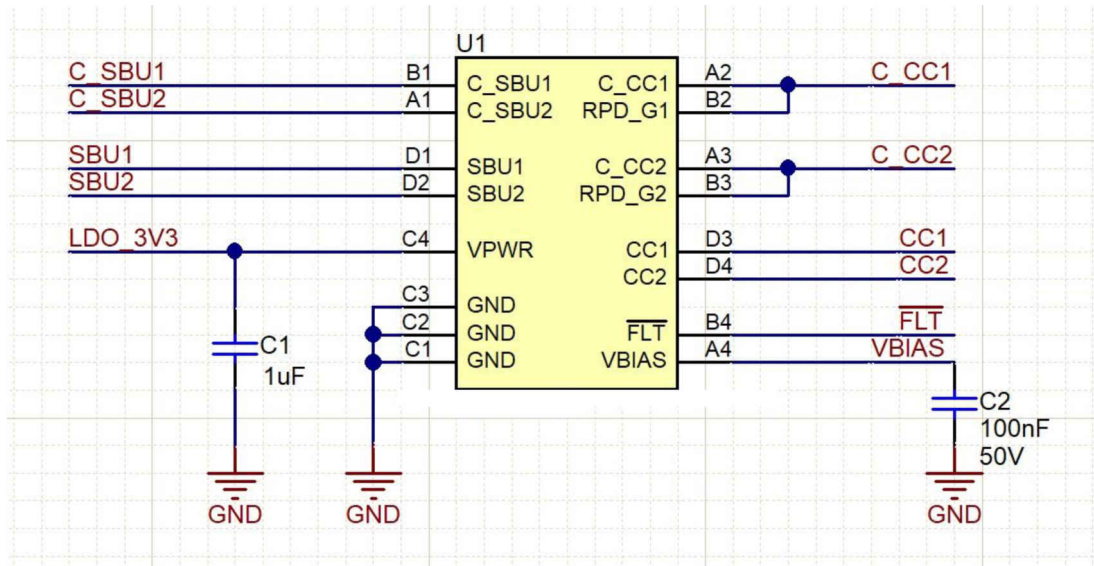
表 9-1. Design Parameters

DESIGN PARAMETER	EXAMPLE VALUE
V_{BUS} nominal operating voltage	20 V
Short-to- V_{BUS} tolerance for the CC and SBU pins	24 V
VBIAS nominal capacitance	0.1 μ F
Dead battery charging	100 W
Maximum ambient temperature requirement	85°C

9.2.2 Detailed Design Procedure

9.2.2.1 VBIAS Capacitor Selection

As noted in the [Recommended Operating Conditions](#) table, a minimum of $35\text{-}V_{\text{BUS}}$ rated capacitor is required for the VBIAS pin, and a $50\text{-}V_{\text{BUS}}$ capacitor is recommended. The VBIAS capacitor is in parallel with the central diode clamp integrated inside the TPD4S311. A forward biased hiding diode connects the VBIAS pin to the C_CCx and C_SBUx pins. Therefore, when a Short-to- V_{BUS} event occurs at 20 V, $20\text{-}V_{\text{BUS}}$ minus a forward biased diode drop is exposed to the VBIAS pin. Additionally, during the short-to- V_{BUS} event, ringing can occur almost double the settling voltage of 20 V, allowing a potential 40 V to be exposed to the C_CCx and C_SBUx pins. However, the internal diode clamps limit the voltage exposed to the C_CCx and C_SBUx pins to around 30 V. Therefore, at least $35\text{-}V_{\text{BUS}}$ capacitor is required to insure the VBIAS capacitor does not get destroyed during Short-to- V_{BUS} events.

A 50-V, X7R capacitor is recommended to further improve the derating performance of the capacitors. When the voltage across a real capacitor is increased, its capacitance value derates. The more the capacitor derates, the greater than 2x ringing can occur in the short-to- V_{BUS} RLC circuit. The 50-V X7R capacitors have great derating performance, allowing for the best short-to- V_{BUS} performance of the TPD4S311.

Additionally, the VBIAS capacitor helps pass IEC 61000-4-2 ESD strikes. The more capacitance present, the better the IEC performance. So the less the VBIAS capacitor derates, the better the IEC performance. [表 9-2](#) shows real capacitors recommended to achieve the best performance with the TPD4S311.

表 9-2. Design Parameters

CAPACITOR SIZE	PART NUMBER
0402	CC0402KRX7R9BB104
0603	GRM188R71H104KA93D

9.2.2.2 Dead Battery Operation

For this application, we want to support 100-W dead battery operation; when the laptop is out of battery, we still want to charge the laptop at 20 V and 5 A. This means that the USB PD Controller must receive power in dead battery mode. The TPS65982 has its own built in LDO in order to supply the TPS65982 power from V_{BUS} in a dead battery condition. The TPS65982 can also provide power to its flash during this condition through its LDO_3V3 pin.

The OVP FETs of the TPD4S311 remain OFF when it is unpowered in order to insure in a dead battery situation proper protection is still provided to the PD controller in the system, in this case the TPS65982. However, when the OVP FETs are OFF, this isolates the TPS65982s dead battery resistors from the USB Type-C ports CC pins. A USB Type-C power adaptor must see the RD pull-down dead battery resistors on the CC pins or it does not provide power on V_{BUS} . Since the TPS65982s dead battery resistors are isolated from the USB Type-C connector's CC pins, the built-in, dead battery resistors of the TPD4S311 must be connected. Short the RPD_G1 pin to the C_CC1 pin, and short the RPD_G2 pin to the C_CC2 pin.

Once the power adaptor sees the dead battery resistors of the TPD4S311, it applies 5 V on the V_{BUS} pin. This provides power to the TPS65982, turning the PD controller on, and allowing the battery to begin to charge. However, this application requires 100 W charging in dead battery mode, so V_{BUS} at 20 V and 5 A is required. USB PD negotiation is required to accomplish this, so the TPS65982 needs to be able to communicate on the CC pins. This means the TPD4S311 needs to be turned on in dead battery mode as well so the TPS65982s PD controller can be exposed to the CC lines. To accomplish this, it is critical that the TPD4S311 is powered by the TPS65982s internal LDO, the LDO_3V3 pin. This way, when the TPS65982 receives power on V_{BUS} , the TPD4S311 is turned on simultaneously.

It is critical that the TPS65982's dead battery resistors are also connected to its CC pins for dead battery operation. Short the TPS65982s RPD_G1 pin to its C_CC1 pin, and its RPD_G2 pin to its C_CC2 pin. It is critical that the TPS65982s dead battery resistors are present; once the TPD4S311 receives power, turns on its OVP FETs and then removes its dead battery RD resistor, TPS65982's RD pull-down resistors must be present on the CC line in order to guarantee the power adaptor stays connected. If RD is not present the power adaptor will eventually interpret this as a disconnect and remove V_{BUS} .

Also, it is important that the TPS65982's dead battery resistors are present so it properly boots up in dead battery operation with the correct voltages on its CC pins.

Once this process has occurred, the TPS65982 can start negotiating with the power adaptor through USB PD for higher power levels, allowing 100-W operation in dead battery mode.

For more information on the TPD4S311 dead battery operation, see the [CC Dead Battery Resistors Integrated for Handling the Dead Battery Use Case in Mobile Devices](#) section of the datasheet.

9.2.2.3 CC Line Capacitance

USB PD has a specification for the total amount of capacitance that is required for proper USB PD BMC operation on the CC lines. The specification from section 5.8.6 of the [USB PD Specification](#) is given below in [表 9-3](#).

表 9-3. USB PD cReceiver Specification

NAME	DESCRIPTION	MIN	MAX	UNIT	COMMENT
cReceiver	CC receiver capacitance	200	600	pF	The DFP or UFP system shall have capacitance within this range when not transmitting on the line

Therefore, the capacitance on the CC lines must stay in between 200 pF and 600 pF when USB PD is being used. Therefore, the combination of capacitances added to the system by the TPS65982, the TPD4S311, and any external capacitor must fall within these limits. [表 9-4](#) shows the analysis involved in choosing the correct external CC capacitor for this system, and shows that an external CC capacitor is required.

表 9-4. CC Line Capacitor Calculation

CC CAPACITANCE	MIN	MAX	UNIT	COMMENT
CC line target capacitance	200	600	pF	From the USB PD Specification section
TPS65982 capacitance	70	120	pF	From the TPS65982 data sheet
TPD4S311 capacitance	45	120	pF	From the Electrical Characteristics table
Proposed capacitor GRM033R71E221KA01D	110	330	pF	CAP, CERM, 220 pF, 25 V, ±10%, X7R, 0201 (for min and max, assume ±50% capacitance change with temperature and voltage derating to be overly conservative)
TPS65982 + TPD4S311 + GRM033R71E221KA01D	225	570	pF	Meets USB PD cReceiver specification

9.2.2.4 Additional ESD Protection on CC and SBU Lines

If additional IEC ESD protection is desired to be placed on either the CC or SBU lines, it is important that high-voltage ESD protection diodes be used. The maximum DC voltage that can be seen in USB PD is $21-V_{BUS}$, with 21.5 V allowed during voltage transitions. Therefore, an ESD protection diode must have a reverse stand off voltage higher than 21.5 V in order to guarantee the diode does not breakdown during a short-to- V_{BUS} event and have large amounts of current flowing through it indefinitely, destroying the diode. A reverse stand off voltage of 24 V is recommended to give margin above 21.5 V in case USB Type-C power adaptors are released in the market which break the USB Type-C specification.

Furthermore, due to the fact that the Short-to- V_{BUS} event applies a DC voltage to the CC and SBU pins, a deep-snap-back diode cannot be used unless its minimum trigger voltage is above 42 V. During a Short-to- V_{BUS} event, RLC ringing of up to 2x the settling voltage can be exposed to CC and SBU, allowing for up to 42 V to be exposed. Furthermore, if any capacitor derates on the CC or SBU line, greater than 2x ringing can occur. Since this ringing is hard to bound, it is recommended to not use deep-snap-back diodes. If the deep-snap-back diode triggers during the short-to- V_{BUS} hot-plug event, it begins to operate in its conduction region. With a $20-V_{BUS}$ source present on the CC or SBU line, this allows the diode to conduct indefinitely, destroying the diode.

9.2.2.5 FLT Pin Operation

Once a Short-to- V_{BUS} occurs on the C_{CCx} or C_{SBUx} pins, the FLT pin is asserted in 20 μs (typical) so the PD controller can be notified quickly. If V_{BUS} is being shorted to CC or SBU, it is recommended to respond to the

event by forcing a detach in the USB PD controller to remove V_{BUS} from the port. Although the USB Type-C port using the TPD4S311 is not damaged, as the TPD4S311 provides protection from these events, the other device connected through the USB Type-C Cable or any active circuitry in the cable can be damaged. Although shutting the V_{BUS} off through a detach does not guarantee it stops the other device or cable from being damaged, it can mitigate any high current paths from causing further damage after the initial damage takes place. Additionally, even if the active cable or other device does have proper protection, the short-to- V_{BUS} event may corrupt a configuration in an active cable or in the other PD controller, so it is best to detach and reconfigure the port.

9.2.2.6 How to Connect Unused Pins

If either the RPD_Gx pins are unused in a design, they must be connected to GND.

9.2.3 Application Curves



图 9-3. TPD4S311 Turning On in Dead Battery Mode with R_D on CC1



图 9-4. TPD4S311 Protecting the TPS65982 During a Short-to- V_{BUS} Event

10 Power Supply Recommendations

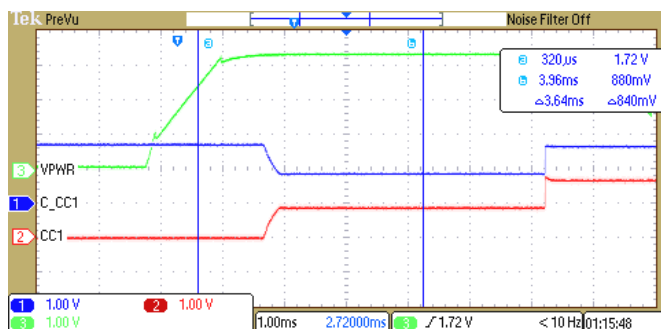
The V_{PWR} pin provides power to all the circuitry in the TPD4S311. It is recommended a 1- μ F decoupling capacitor is placed as close as possible to the VPWR pin. If USB PD is desired to be operated in dead battery conditions, it is critical that the TPD4S311 share the same power supply as the PD controller in dead battery boot-up (such as sharing the same dead battery LDO). See the [CC Dead Battery Resistors Integrated for Handling the Dead Battery Use Case in Mobile Devices](#) section for more details.

11 Layout

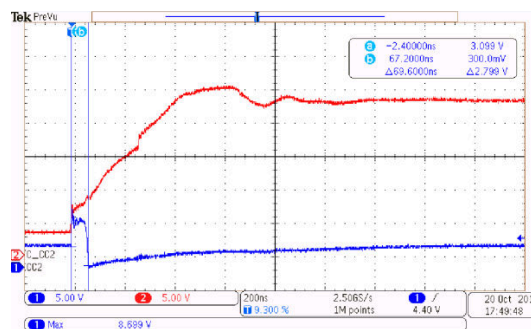
11.1 Layout Guidelines

Proper routing and placement is important to maintain the signal integrity the SBU and CC line signals. The following guidelines apply to the TPD4S311:

- Place the bypass capacitors as close as possible to the V_{PWR} pin, and ESD protection capacitor as close as possible to the V_{BIAS} pin. Capacitors must be attached to a solid ground. This minimizes voltage disturbances during transient events such as short-to- V_{BUS} and ESD strikes.
- The SBU lines must be routed as straight as possible and any sharp bends must be minimized.

Standard ESD recommendations apply to the C_CC1, C_CC2, C_SBU1, C_SBU2:

- The optimum placement for the device is as close to the connector as possible:
 - EMI during an ESD event can couple from the trace being struck to other nearby unprotected traces, resulting in early system failures.
 - The PCB designer must minimize the possibility of EMI coupling by keeping any unprotected traces away from the protected traces which are between the TPD4S311 and the connector.
- Route the protected traces as straight as possible.
- Eliminate any sharp corners on the protected traces between the TVS and the connector by using rounded corners with the largest radii possible.
 - Electric fields tend to build up on corners, increasing EMI coupling.

11.2 Layout Example



图 11-1. TPD4S311 Top Layer Routing



图 11-2. TPD4S311 Bottom Layer Routing

12 Device and Documentation Support

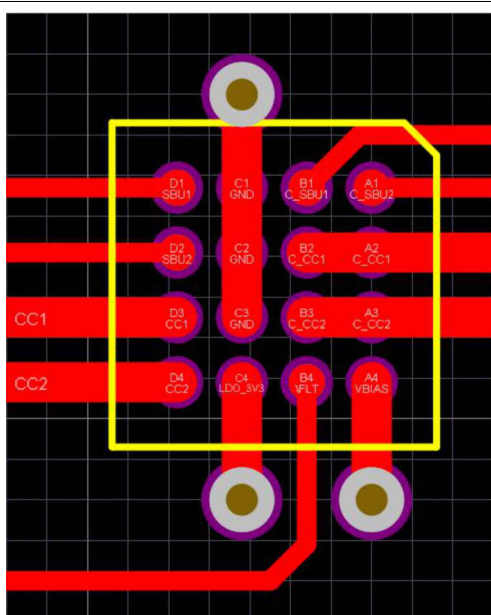
12.1 Documentation Support

12.1.1 Related Documentation

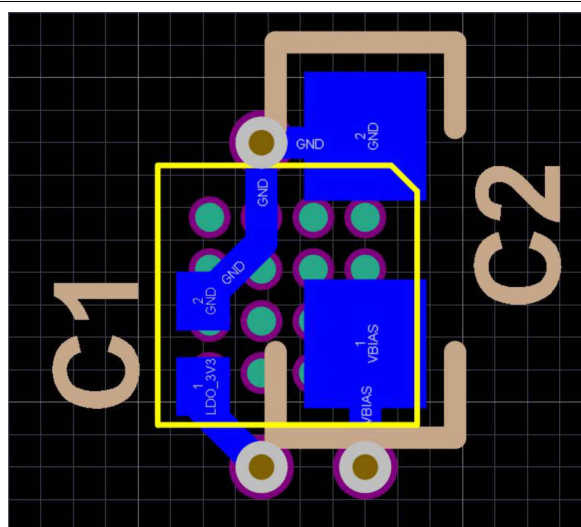
For related documentation see the following:

[TPD6S300 Evaluation Module User's Guide](#)

[TPS65982 USB Type-C and USB PD Controller, Power Switch, and High-Speed Multiplexer](#)

12.2 接收文档更新通知

要接收文档更新通知，请导航至 [ti.com](#) 上的器件产品文件夹。点击 [订阅更新](#) 进行注册，即可每周接收产品信息更改摘要。有关更改的详细信息，请查看任何已修订文档中包含的修订历史记录。

12.3 支持资源

[TI E2E™ 支持论坛](#) 是工程师的重要参考资料，可直接从专家获得快速、经过验证的解答和设计帮助。搜索现有解答或提出自己的问题可获得所需的快速设计帮助。

链接的内容由各个贡献者“按原样”提供。这些内容并不构成 TI 技术规范，并且不一定反映 TI 的观点；请参阅 TI 的《[使用条款](#)》。

12.4 Trademarks

USB Type-C™ are trademarks of USB Implementers Forum.

TI E2E™ is a trademark of Texas Instruments.

所有商标均为其各自所有者的财产。

12.5 静电放电警告



静电放电 (ESD) 会损坏这个集成电路。德州仪器 (TI) 建议通过适当的预防措施处理所有集成电路。如果不遵守正确的处理和安装程序，可能会损坏集成电路。

ESD 的损坏小至导致微小的性能降级，大至整个器件故障。精密的集成电路可能更容易受到损坏，这是因为非常细微的参数更改都可能会导致器件与其发布的规格不相符。



12.6 术语表

[TI 术语表](#) 本术语表列出并解释了术语、首字母缩略词和定义。

13 Mechanical, Packaging, and Orderable Information

The following pages include mechanical, packaging, and orderable information. This information is the most current data available for the designated devices. This data is subject to change without notice and revision of this document. For browser-based versions of this data sheet, refer to the left-hand navigation.

PACKAGING INFORMATION

Orderable Device	Status (1)	Package Type	Package Drawing	Pins	Package Qty	Eco Plan (2)	Lead finish/ Ball material (6)	MSL Peak Temp (3)	Op Temp (°C)	Device Marking (4/5)	Samples
TPD4S311AYBFR	ACTIVE	DSBGA	YBF	16	3000	RoHS & Green	SNAGCU	Level-1-260C-UNLIM	-40 to 85	4S311 A1	
TPD4S311YBFR	ACTIVE	DSBGA	YBF	16	3000	RoHS & Green	SAC396	Level-1-260C-UNLIM	-40 to 85	4S311 A0	

(1) The marketing status values are defined as follows:

ACTIVE: Product device recommended for new designs.

LIFEBUY: TI has announced that the device will be discontinued, and a lifetime-buy period is in effect.

NRND: Not recommended for new designs. Device is in production to support existing customers, but TI does not recommend using this part in a new design.

PREVIEW: Device has been announced but is not in production. Samples may or may not be available.

OBSOLETE: TI has discontinued the production of the device.

(2) **RoHS:** TI defines "RoHS" to mean semiconductor products that are compliant with the current EU RoHS requirements for all 10 RoHS substances, including the requirement that RoHS substance do not exceed 0.1% by weight in homogeneous materials. Where designed to be soldered at high temperatures, "RoHS" products are suitable for use in specified lead-free processes. TI may reference these types of products as "Pb-Free".

RoHS Exempt: TI defines "RoHS Exempt" to mean products that contain lead but are compliant with EU RoHS pursuant to a specific EU RoHS exemption.

Green: TI defines "Green" to mean the content of Chlorine (Cl) and Bromine (Br) based flame retardants meet JS709B low halogen requirements of <=1000ppm threshold. Antimony trioxide based flame retardants must also meet the <=1000ppm threshold requirement.

(3) MSL, Peak Temp. - The Moisture Sensitivity Level rating according to the JEDEC industry standard classifications, and peak solder temperature.

(4) There may be additional marking, which relates to the logo, the lot trace code information, or the environmental category on the device.

(5) Multiple Device Markings will be inside parentheses. Only one Device Marking contained in parentheses and separated by a "~" will appear on a device. If a line is indented then it is a continuation of the previous line and the two combined represent the entire Device Marking for that device.

(6) Lead finish/Ball material - Orderable Devices may have multiple material finish options. Finish options are separated by a vertical ruled line. Lead finish/Ball material values may wrap to two lines if the finish value exceeds the maximum column width.

Important Information and Disclaimer:The information provided on this page represents TI's knowledge and belief as of the date that it is provided. TI bases its knowledge and belief on information provided by third parties, and makes no representation or warranty as to the accuracy of such information. Efforts are underway to better integrate information from third parties. TI has taken and continues to take reasonable steps to provide representative and accurate information but may not have conducted destructive testing or chemical analysis on incoming materials and chemicals. TI and TI suppliers consider certain information to be proprietary, and thus CAS numbers and other limited information may not be available for release.

In no event shall TI's liability arising out of such information exceed the total purchase price of the TI part(s) at issue in this document sold by TI to Customer on an annual basis.

TAPE AND REEL INFORMATION

QUADRANT ASSIGNMENTS FOR PIN 1 ORIENTATION IN TAPE

*All dimensions are nominal

Device	Package Type	Package Drawing	Pins	SPQ	Reel Diameter (mm)	Reel Width W1 (mm)	A0 (mm)	B0 (mm)	K0 (mm)	P1 (mm)	W (mm)	Pin1 Quadrant
TPD4S311AYBFR	DSBGA	YBF	16	3000	180.0	8.4	1.86	1.86	0.62	4.0	8.0	Q1
TPD4S311AYBFR	DSBGA	YBF	16	3000	178.0	9.2	1.86	1.86	0.62	4.0	8.0	Q1
TPD4S311YBFR	DSBGA	YBF	16	3000	180.0	8.4	1.86	1.86	0.62	4.0	8.0	Q1

TAPE AND REEL BOX DIMENSIONS

*All dimensions are nominal

Device	Package Type	Package Drawing	Pins	SPQ	Length (mm)	Width (mm)	Height (mm)
TPD4S311AYBFR	DSBGA	YBF	16	3000	182.0	182.0	20.0
TPD4S311AYBFR	DSBGA	YBF	16	3000	220.0	220.0	35.0
TPD4S311YBFR	DSBGA	YBF	16	3000	182.0	182.0	20.0

YBF0016

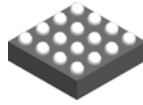

PACKAGE OUTLINE

DSBGA - 0.55 mm max height

DIE SIZE BALL GRID ARRAY

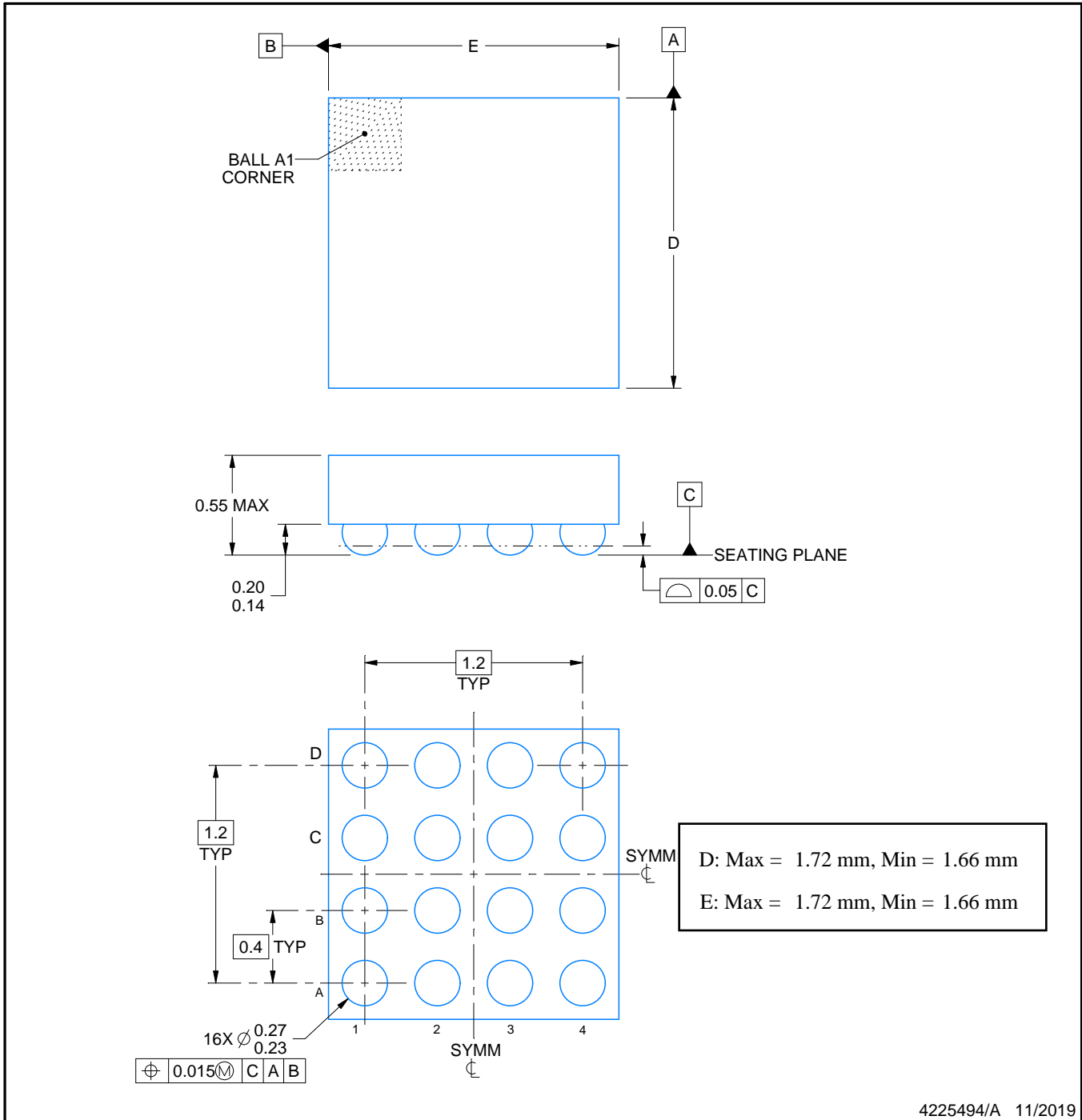

NOTES:

1. All linear dimensions are in millimeters. Any dimensions in parenthesis are for reference only. Dimensioning and tolerancing per ASME Y14.5M.
2. This drawing is subject to change without notice.

EXAMPLE BOARD LAYOUT

YBF0016

DSBGA - 0.55 mm max height

DIE SIZE BALL GRID ARRAY

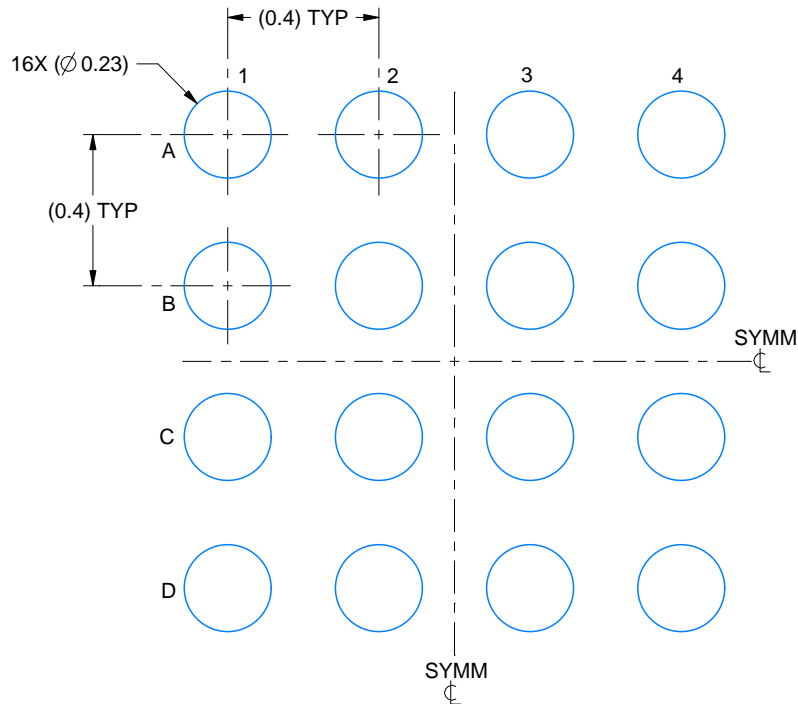

LAND PATTERN EXAMPLE
EXPOSED METAL SHOWN
SCALE: 50X

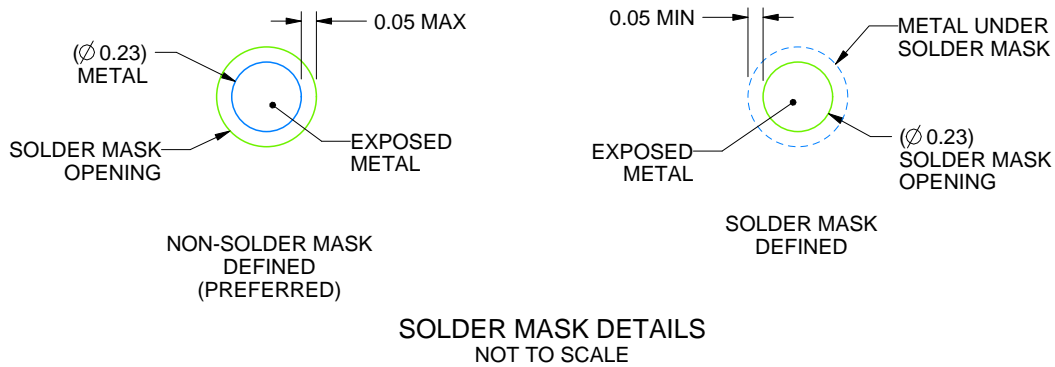

SOLDER MASK DETAILS
NOT TO SCALE

4225494/A 11/2019

NOTES: (continued)

- Final dimensions may vary due to manufacturing tolerance considerations and also routing constraints. See Texas Instruments Literature No. SNVA009 (www.ti.com/lit/snva009).

EXAMPLE STENCIL DESIGN

YBF0016

DSBGA - 0.55 mm max height

DIE SIZE BALL GRID ARRAY

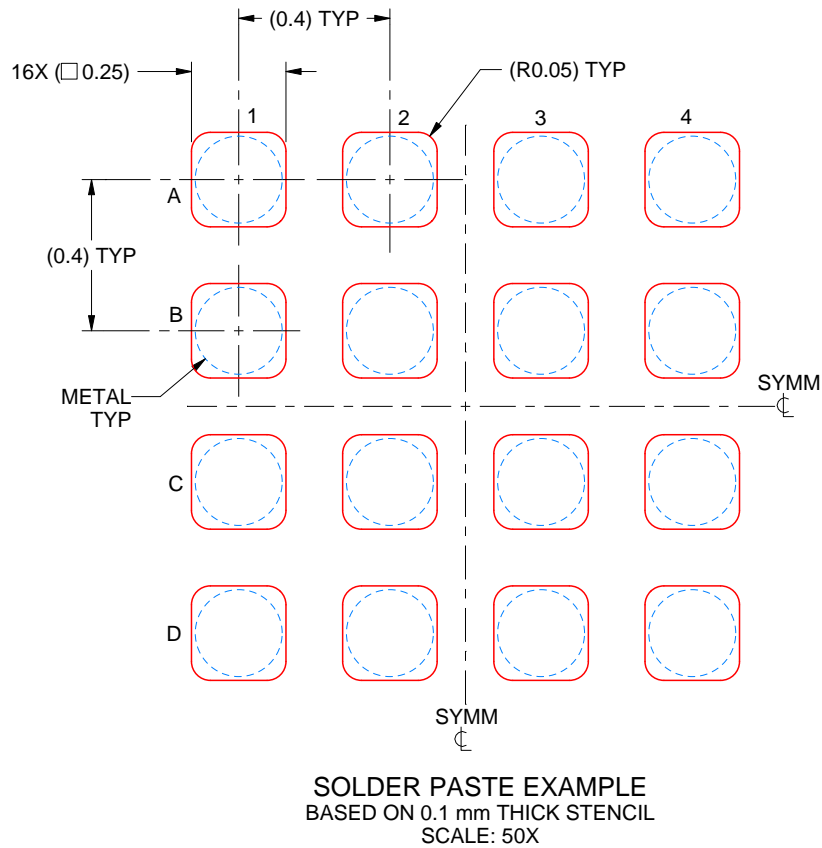

4225494/A 11/2019

NOTES: (continued)

4. Laser cutting apertures with trapezoidal walls and rounded corners may offer better paste release.

重要声明和免责声明

TI“按原样”提供技术和可靠性数据（包括数据表）、设计资源（包括参考设计）、应用或其他设计建议、网络工具、安全信息和其他资源，不保证没有瑕疵且不做任何明示或暗示的担保，包括但不限于对适销性、某特定用途方面的适用性或不侵犯任何第三方知识产权的暗示担保。

这些资源可供使用 TI 产品进行设计的熟练开发人员使用。您将自行承担以下全部责任：(1) 针对您的应用选择合适的 TI 产品，(2) 设计、验证并测试您的应用，(3) 确保您的应用满足相应标准以及任何其他功能安全、信息安全、监管或其他要求。

这些资源如有变更，恕不另行通知。TI 授权您仅可将这些资源用于研发本资源所述的 TI 产品的应用。严禁对这些资源进行其他复制或展示。您无权使用任何其他 TI 知识产权或任何第三方知识产权。您应全额赔偿因在这些资源的使用中对 TI 及其代表造成的任何索赔、损害、成本、损失和债务，TI 对此概不负责。

TI 提供的产品受 [TI 的销售条款](#) 或 [ti.com](#) 上其他适用条款/TI 产品随附的其他适用条款的约束。TI 提供这些资源并不会扩展或以其他方式更改 TI 针对 TI 产品发布的适用的担保或担保免责声明。

TI 反对并拒绝您可能提出的任何其他或不同的条款。

邮寄地址：Texas Instruments, Post Office Box 655303, Dallas, Texas 75265

Copyright © 2023，德州仪器 (TI) 公司