



## DUAL PROCESSOR SUPERVISORS

### FEATURES

- Dual Supervisory Circuits for DSP- and Processor-Based Systems
- Power-On Reset Generator with Fixed Delay Time of 200ms; no External Capacitor Needed
- Watchdog Timer Retriggeres the  $\overline{\text{RESET}}$  Output at  $\text{SENSEn} \geq V_{IT+}$
- Temperature-Compensated Voltage Reference
- Maximum Supply Current of 40 $\mu\text{A}$
- Supply Voltage Range: 2.7V to 6V
- Defined  $\overline{\text{RESET}}$  Output From  $V_{DD} \geq 1.1\text{V}$
- MSOP-8 and SO-8 Packages
- Temperature Range:  $-40^{\circ}\text{C}$  to  $+85^{\circ}\text{C}$

### APPLICATIONS

- Processor Supply Monitoring
- Industrial Equipment
- Automotive Systems
- Portable/Battery-Powered Equipment
- Wireless Communication Systems
- Notebook/Desktop Computers

### DESCRIPTION

The TPS3305 family is a series of micropower supply voltage supervisors designed for circuit initialization. Its dual monitor topology is well-suited to use in DSP and processor-based systems, which often require two supply voltages, core and I/O.

$\overline{\text{RESET}}$  is asserted when the voltage at either SENSEn pin falls below its threshold voltage,  $V_{IT}$ . When both SENSEn pins are again above their respective threshold voltages,  $\overline{\text{RESET}}$  is held low for the factory-programmed delay time (200ms typ).  $\overline{\text{RESET}}$  is also asserted if the watchdog input (WDI) is not toggled for more than 1.6s typ.

The TPS3305-xx devices are available in either 8-pin MSOP or SO packages, and are specified for operation over a temperature range of  $-40^{\circ}\text{C}$  to  $+85^{\circ}\text{C}$ .

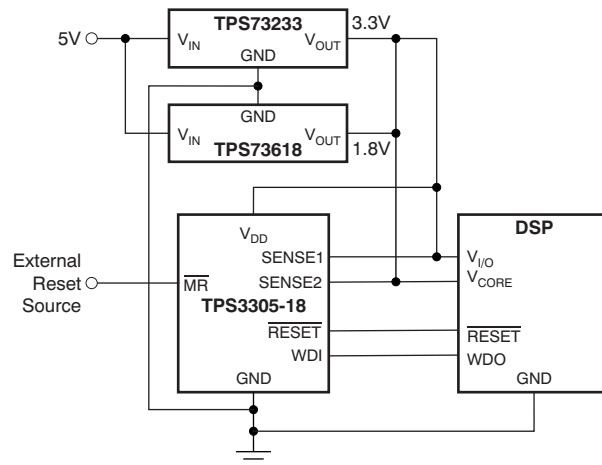
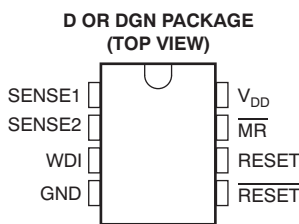

Please be aware that an important notice concerning availability, standard warranty, and use in critical applications of Texas Instruments semiconductor products and disclaimers thereto appears at the end of this data sheet.

All trademarks are the property of their respective owners.



This integrated circuit can be damaged by ESD. Texas Instruments recommends that all integrated circuits be handled with appropriate precautions. Failure to observe proper handling and installation procedures can cause damage.

ESD damage can range from subtle performance degradation to complete device failure. Precision integrated circuits may be more susceptible to damage because very small parametric changes could cause the device not to meet its published specifications.

**ORDERING INFORMATION<sup>(1)</sup>**

DEVICE	NOMINAL SUPERVISED VOLTAGE		THRESHOLD VOLTAGE (TYP)	
	SENSE1	SENSE2	SENSE1	SENSE2
TPS3305-18	3.3 V	1.8 V	2.93 V	1.68 V
TPS3305-25	3.3 V	2.5 V	2.93 V	2.25 V
TPS3305-33	5.0 V	3.3 V	4.55 V	2.93 V

(1) For the most current specifications and package information, see the Package Option Addendum at the end of this document, or see the TI website at [www.ti.com](http://www.ti.com).

**ABSOLUTE MAXIMUM RATINGS<sup>(1)(2)</sup>**

Over operating junction temperature range (unless otherwise noted).

	UNIT
Supply voltage range, $V_{DD}$	-0.3V to +7V
$V_{MR}$ , $V_{WDI}$	-0.3V to $V_{DD} + 0.3V$
Input voltage at SENSE1 and SENSE2, $V_I$	$(V_{DD} + 0.3)V_{IT} / 1.25V$
$V_{RESET}$ , $V_{\overline{RESET}}$	-0.3V to +7V
Maximum low output current, $I_{OL}$	5mA
Maximum high output current, $I_{OH}$	-5mA
Input clamp current, $I_{IK}$ ( $V_I < 0$ or $V_I > V_{DD}$ )	$\pm 20mA$
Output clamp current, $I_{OK}$ ( $V_O < 0$ or $V_O > V_{DD}$ )	$\pm 20mA$
Continuous total power dissipation	See <a href="#">Dissipation Ratings Table</a>
Operating junction temperature range, $T_J$	-40°C to +85°C
Storage temperature range, $T_{stg}$	-65°C to +150°C
Soldering temperature	+260°C

(1) Stresses beyond those listed under *absolute maximum ratings* may cause permanent damage to the device. These are stress ratings only, and functional operation of the device at these or any other conditions beyond those indicated under *recommended operating conditions* is not implied. Exposure to absolute-maximum-rated conditions for extended periods may affect device reliability.

(2) All voltage values are with respect to GND.

**DISSIPATION RATINGS TABLE**

PACKAGE	$T_A \leq +25^\circ C$ POWER RATING	DERATING FACTOR ABOVE $T_A = +25^\circ C$	$T_A = +70^\circ C$ POWER RATING	$T_A = +85^\circ C$ POWER RATING
DGN	2.14W	17.1mW/°C	1.37W	1.11W
D	725mW	5.8mW/°C	464mW	377mW

## ELECTRICAL CHARACTERISTICS

Over operating junction temperature range (unless otherwise noted).

PARAMETER		TEST CONDITIONS	TPS3305-xx			UNIT		
			MIN	TYP	MAX			
V <sub>DD</sub>	Input supply range		2.7		6.0	V		
T <sub>J</sub>	Operating junction temperature range		-40		+85	°C		
V <sub>OH</sub>	High-level output voltage	V <sub>DD</sub> = 2.7V to 6V, I <sub>OH</sub> = -20μA	V <sub>DD</sub> - 0.2V			V		
		V <sub>DD</sub> = 3.3V, I <sub>OH</sub> = -2mA	V <sub>DD</sub> - 0.4V			V		
		V <sub>DD</sub> = 6V, I <sub>OH</sub> = -3mA	V <sub>DD</sub> - 0.4V			V		
V <sub>OL</sub>	Low-level output voltage	V <sub>DD</sub> = 2.7V to 6V, I <sub>OL</sub> = 20μA				0.2	V	
		V <sub>DD</sub> = 3.3V, I <sub>OL</sub> = 2mA				0.4	V	
		V <sub>DD</sub> = 6V, I <sub>OL</sub> = 3mA				0.4	V	
Power-up reset voltage <sup>(1)</sup>		V <sub>DD</sub> ≥ 1.1V, I <sub>OL</sub> = 20μA				0.4	V	
V <sub>IT-</sub>	Negative-going input threshold voltage <sup>(2)</sup>	V <sub>DD</sub> = 2.7V to 6V, T <sub>A</sub> = 0°C to +85°C	VSENSE1, VSENSE2	1.64	1.68	1.72	V	
				2.20	2.25	2.30	V	
				2.86	2.93	3.0	V	
				4.46	4.55	4.64	V	
		VSENSE1, VSENSE2	V <sub>DD</sub> = 2.7V to 6V, T <sub>A</sub> = -40°C to +85°C		1.64	1.68	1.73	V
					2.20	2.25	2.32	V
					2.86	2.93	3.02	V
					4.46	4.55	4.67	V
V <sub>hys</sub>	Hysteresis at VSENSEn input	V <sub>IT-</sub> = 1.68V				15	mV	
		V <sub>IT-</sub> = 2.25V				20	mV	
		V <sub>IT-</sub> = 2.93V				30	mV	
		V <sub>IT-</sub> = 4.55V				40	mV	
I <sub>H(AV)</sub>	Average high-level input current	WDI	WDI = V <sub>DD</sub> = 6V Time average (dc = 88%)		100	150	μA	
I <sub>L(AV)</sub>	Average low-level input current	WDI	WDI = 0V, V <sub>DD</sub> = 6V Time average (dc = 12%)		-15	-20	μA	
V <sub>IH</sub>	High-level input voltage at $\overline{MR}$ and WDI		0.7 x V <sub>DD</sub>			V		
V <sub>IL</sub>	Low-level input voltage at $\overline{MR}$ and WDI		0.3 x V <sub>DD</sub>			V		
Δt / ΔV	Input transition rise and fall rate at $\overline{MR}$					50	ns/V	
I <sub>H</sub>	High-level input current	WDI	WDI = V <sub>DD</sub> = 6V		120	170	μA	
		$\overline{MR}$	$\overline{MR} = 0.7 \times V_{DD}$ , V <sub>DD</sub> = 6V		-130	-180	μA	
		SENSE1	VSENSE1 = V <sub>DD</sub> = 6V		5	8	μA	
		SENSE2	VSENSE2 = V <sub>DD</sub> = 6V		6	9	μA	
I <sub>L</sub>	Low-level input current	WDI	WDI = 0V, V <sub>DD</sub> = 6V		-120	-170	μA	
		$\overline{MR}$	$\overline{MR} = 0V$ , V <sub>DD</sub> = 6V		-430	-600	μA	
		SENSEn	VSENSE1,2 = 0V		-1	1	μA	
I <sub>DD</sub>	Supply current					40	μA	
C <sub>I</sub>	Input capacitance	V <sub>I</sub> = 0V to V <sub>DD</sub>				10	pF	

(1) The lowest supply voltage at which **RESET** becomes active. t<sub>r</sub>, V<sub>DD</sub> ≥ 15 μs/V.

(2) To ensure best stability of the threshold voltage, a bypass capacitor (0.1 μF ceramic) should be placed close to the supply terminals.

**TIMING DIAGRAM**

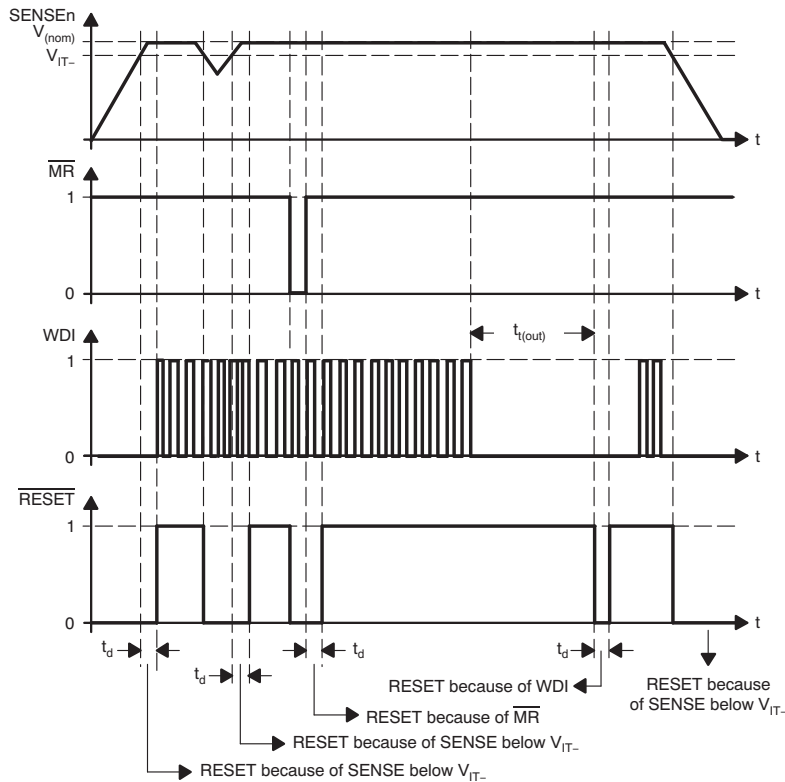

**TIMING REQUIREMENTS**

At  $V_{DD} = 2.7V$  to  $6V$ ,  $R_L = 1M\Omega$ ,  $C_L = 50pF$ , and  $T_J = +25^\circ C$ .

PARAMETER		TEST CONDITIONS	MIN	TYP	MAX	UNIT
$t_w$	Pulse width	$V_{SENSEnL} = V_{IT-} - 0.2V$ , $V_{SENSEnH} = V_{IT+} + 0.2V$	6			$\mu s$
		$V_{IH} = 0.7 \times V_{DD}$ , $V_{IL} = 0.3 \times V_{DD}$	100			ns
			100			ns

**SWITCHING CHARACTERISTICS**

At  $V_{DD} = 2.7V$  to  $6V$ ,  $R_L = 1M\Omega$ ,  $C_L = 50pF$ , and  $T_J = +25^\circ C$ .

PARAMETER		TEST CONDITIONS	MIN	TYP	MAX	UNIT
$t_{t(out)}$	Watchdog time-out	$V_{I(SENSEn)} \geq V_{IT+} + 0.2V$ , $\overline{MR} \geq 0.7 \times V_{DD}$ See <a href="#">Timing Diagram</a>	1.1	1.6	2.3	s
$t_d$	Delay time	$V_{I(SENSEn)} \geq V_{IT+} + 0.2V$ , $\overline{MR} \geq 0.7 \times V_{DD}$ See <a href="#">Timing Diagram</a>	140	200	280	ms
$t_{PHL}$	Propagation (delay) time, high-to-low level output	$\overline{MR}$ to $\overline{RESET}$ , $\overline{MR}$ to RESET $V_{I(SENSEn)} \geq V_{IT+} + 0.2V$ , $V_{IH} = 0.7 \times V_{DD}$ , $V_{IL} = 0.3 \times V_{DD}$		200	500	ns
$t_{PLH}$	Propagation (delay) time, low-to-high level output	$\overline{MR}$ to $\overline{RESET}$ , $\overline{MR}$ to RESET $V_{I(SENSEn)} \geq V_{IT+} + 0.2V$ , $V_{IH} = 0.7 \times V_{DD}$ , $V_{IL} = 0.3 \times V_{DD}$		200	500	ns
$t_{PHL}$	Propagation (delay) time, high-to-low level output	$\overline{SENSEn}$ to $\overline{RESET}$ , $\overline{SENSEn}$ to RESET $V_{IH} = V_{IT+} + 0.2V$ , $V_{IL} = V_{IT-} - 0.2V$ , $\overline{MR} \geq 0.7 \times V_{DD}$		1	5	$\mu s$
$t_{PLH}$	Propagation (delay) time, low-to-high level output	$\overline{SENSEn}$ to $\overline{RESET}$ , $\overline{SENSEn}$ to RESET $V_{IH} = V_{IT+} + 0.2V$ , $V_{IL} = V_{IT-} - 0.2V$ , $\overline{MR} \geq 0.7 \times V_{DD}$		1	5	$\mu s$

**DEVICE INFORMATION**

**FUNCTION/TRUTH TABLE<sup>(1)</sup>**

MR	SENSE1 > V <sub>IT1</sub>	SENSE2 > V <sub>IT2</sub>	RESET	RESET
L	X	X	L	H
H	0	0	L	H
H	0	1	L	H
H	1	0	L	H
H	1	1	H	L

(1) X = Don't care

**FUNCTIONAL BLOCK DIAGRAM**

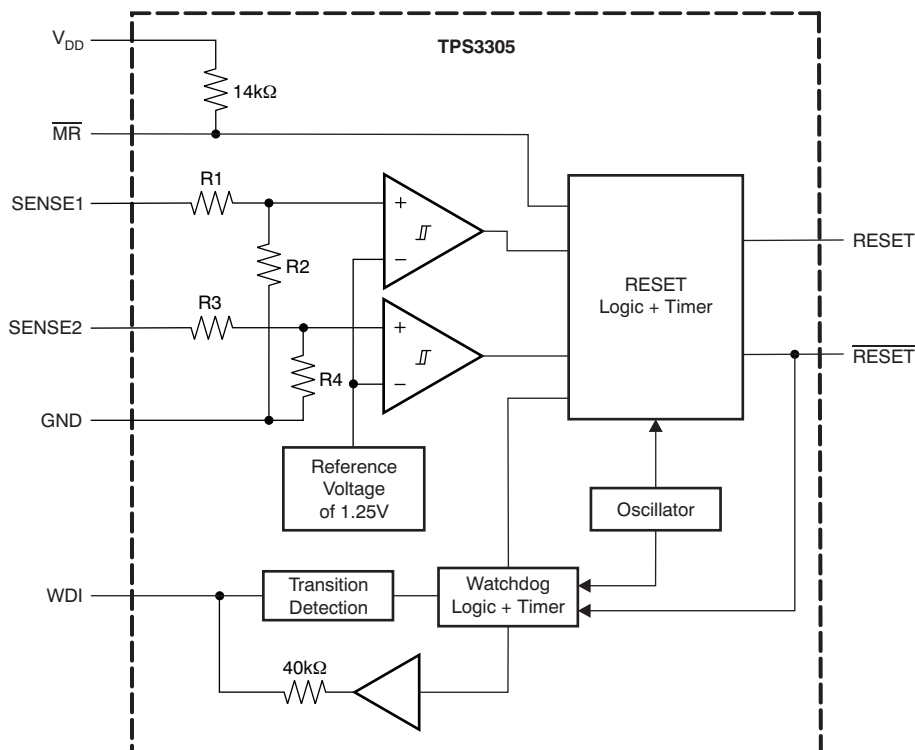

**TERMINAL FUNCTIONS**

TERMINAL		DESCRIPTION
NAME	NO.	
GND	4	Ground
MR	7	Manual reset
RESET	5	Active-low reset output
RESET	6	Active-high reset output
SENSE1	1	Sense voltage input 1
SENSE2	2	Sense voltage input 2
WDI	3	Watchdog timer input
V <sub>DD</sub>	8	Supply voltage

TYPICAL CHARACTERISTICS

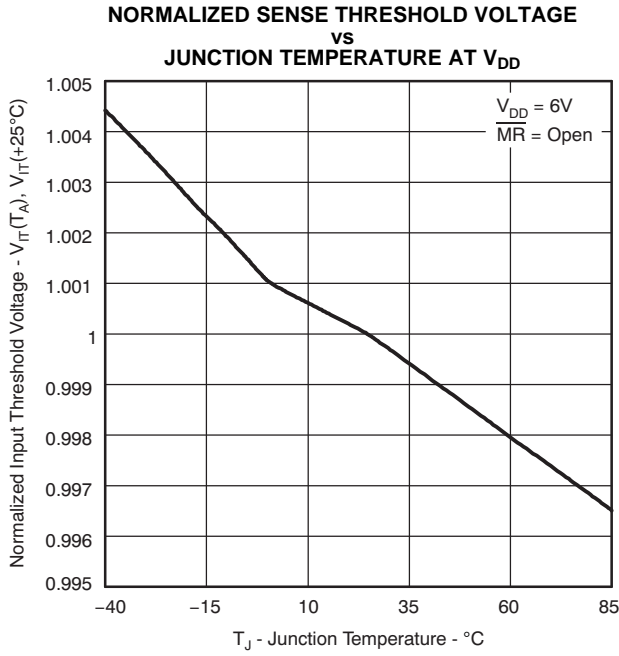

Figure 1.

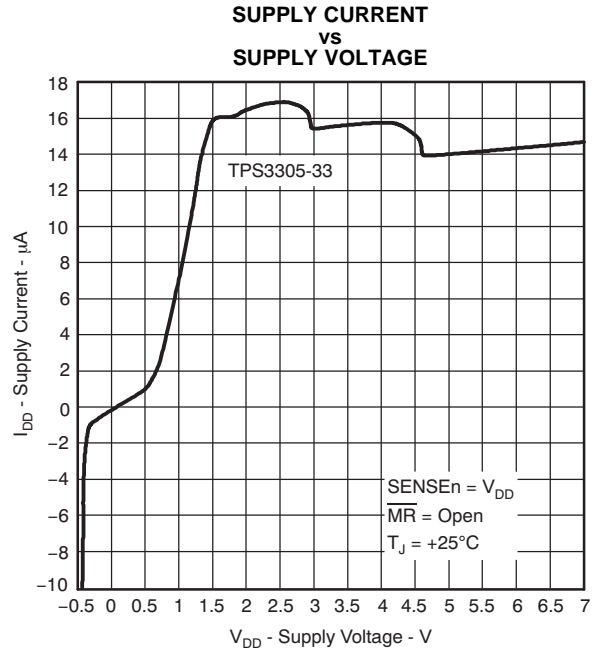

Figure 2.

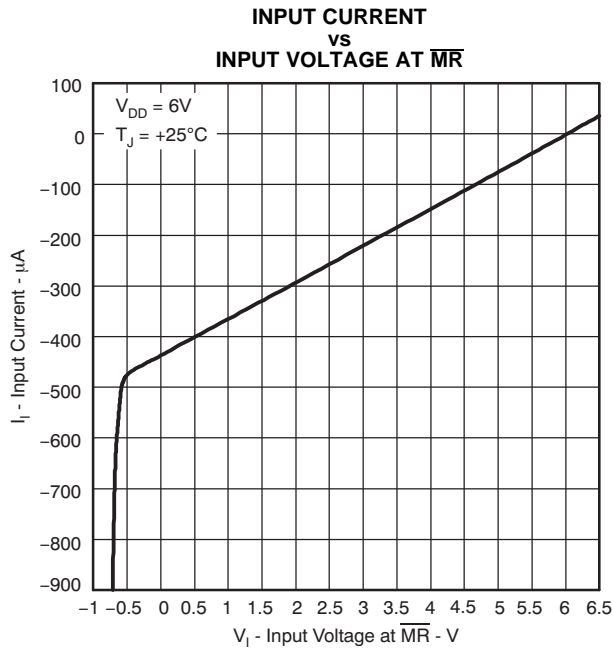

Figure 3.

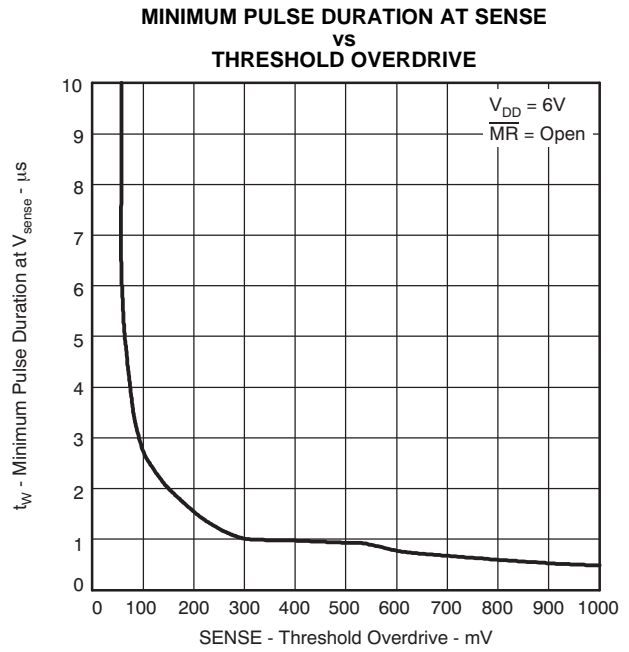
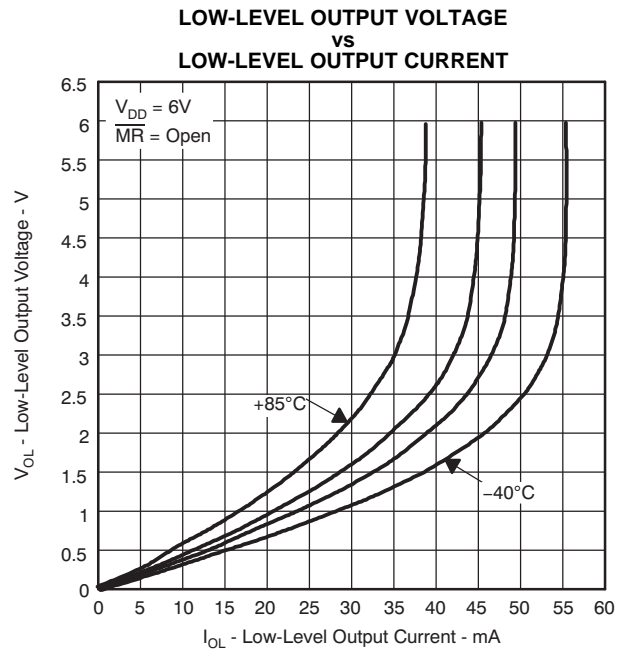
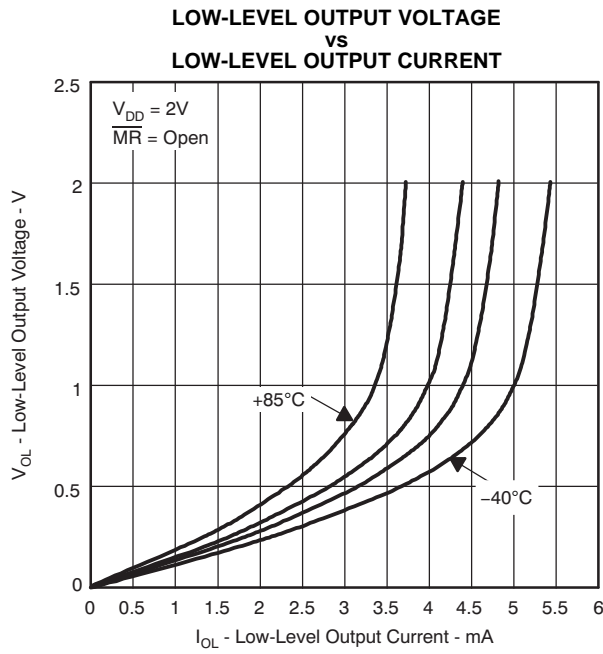
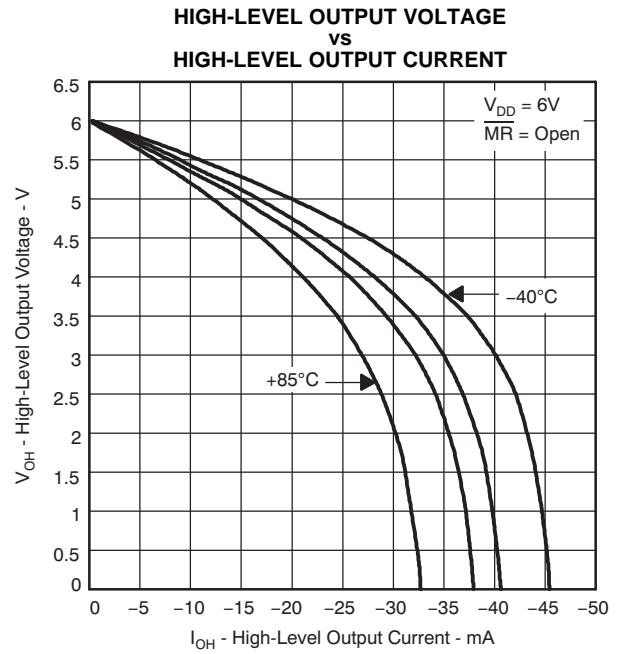
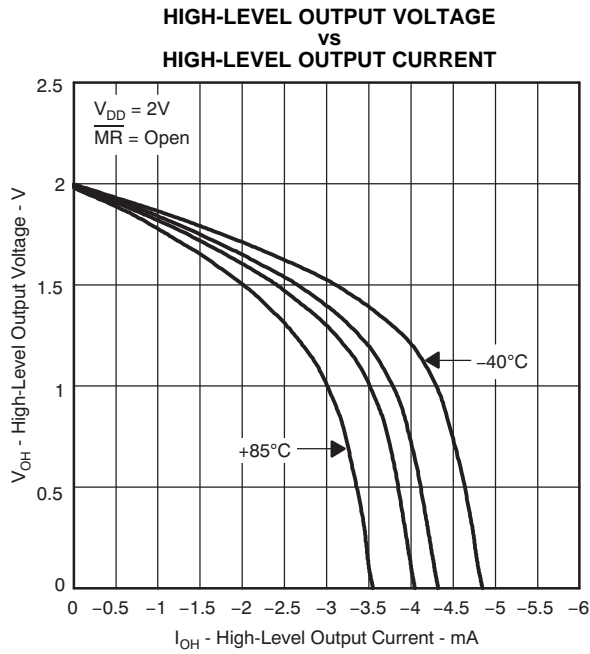

Figure 4.

**TYPICAL CHARACTERISTICS (continued)**



**PACKAGING INFORMATION**

Orderable Device	Status (1)	Package Type	Package Drawing	Pins	Package Qty	Eco Plan (2)	Lead finish/ Ball material (6)	MSL Peak Temp (3)	Op Temp (°C)	Device Marking (4/5)	Samples
TPS3305-18D	ACTIVE	SOIC	D	8	75	RoHS & Green	NIPDAU	Level-1-260C-UNLIM	-40 to 85	30518	<a href="#">Samples</a>
TPS3305-18DG4	LIFEBUY	SOIC	D	8	75	RoHS & Green	NIPDAU	Level-1-260C-UNLIM	-40 to 85	30518	
TPS3305-18DGN	ACTIVE	HVSSOP	DGN	8	80	RoHS & Green	NIPDAU	Level-1-260C-UNLIM	-40 to 85	AAM	<a href="#">Samples</a>
TPS3305-18DGNG4	LIFEBUY	HVSSOP	DGN	8	80	RoHS & Green	NIPDAU	Level-1-260C-UNLIM	-40 to 85	AAM	
TPS3305-18DGNR	ACTIVE	HVSSOP	DGN	8	2500	RoHS & Green	NIPDAU	Level-1-260C-UNLIM	-40 to 85	AAM	<a href="#">Samples</a>
TPS3305-18DGNRG4	LIFEBUY	HVSSOP	DGN	8	2500	RoHS & Green	NIPDAU	Level-1-260C-UNLIM	-40 to 85	AAM	
TPS3305-18DR	ACTIVE	SOIC	D	8	2500	RoHS & Green	NIPDAU	Level-1-260C-UNLIM	-40 to 85	30518	<a href="#">Samples</a>
TPS3305-25D	ACTIVE	SOIC	D	8	75	RoHS & Green	NIPDAU	Level-1-260C-UNLIM	-40 to 85	30525	<a href="#">Samples</a>
TPS3305-25DGN	ACTIVE	HVSSOP	DGN	8	80	RoHS & Green	NIPDAU	Level-1-260C-UNLIM	-40 to 85	AAN	<a href="#">Samples</a>
TPS3305-25DGNR	ACTIVE	HVSSOP	DGN	8	2500	RoHS & Green	NIPDAU	Level-1-260C-UNLIM	-40 to 85	AAN	<a href="#">Samples</a>
TPS3305-25DR	ACTIVE	SOIC	D	8	2500	RoHS & Green	NIPDAU	Level-1-260C-UNLIM	-40 to 85	30525	<a href="#">Samples</a>
TPS3305-33D	ACTIVE	SOIC	D	8	75	RoHS & Green	NIPDAU	Level-1-260C-UNLIM	-40 to 85	30533	<a href="#">Samples</a>
TPS3305-33DG4	LIFEBUY	SOIC	D	8	75	RoHS & Green	NIPDAU	Level-1-260C-UNLIM	-40 to 85	30533	
TPS3305-33DGN	ACTIVE	HVSSOP	DGN	8	80	RoHS & Green	NIPDAU	Level-1-260C-UNLIM	-40 to 85	AAO	<a href="#">Samples</a>
TPS3305-33DGNR	ACTIVE	HVSSOP	DGN	8	2500	RoHS & Green	NIPDAU	Level-1-260C-UNLIM	-40 to 85	AAO	<a href="#">Samples</a>
TPS3305-33DR	ACTIVE	SOIC	D	8	2500	RoHS & Green	NIPDAU	Level-1-260C-UNLIM	-40 to 85	30533	<a href="#">Samples</a>

(1) The marketing status values are defined as follows:

**ACTIVE:** Product device recommended for new designs.

**LIFEBUY:** TI has announced that the device will be discontinued, and a lifetime-buy period is in effect.

**NRND:** Not recommended for new designs. Device is in production to support existing customers, but TI does not recommend using this part in a new design.

**PREVIEW:** Device has been announced but is not in production. Samples may or may not be available.

**OBsolete:** TI has discontinued the production of the device.



(2) **RoHS:** TI defines "RoHS" to mean semiconductor products that are compliant with the current EU RoHS requirements for all 10 RoHS substances, including the requirement that RoHS substance do not exceed 0.1% by weight in homogeneous materials. Where designed to be soldered at high temperatures, "RoHS" products are suitable for use in specified lead-free processes. TI may reference these types of products as "Pb-Free".

**RoHS Exempt:** TI defines "RoHS Exempt" to mean products that contain lead but are compliant with EU RoHS pursuant to a specific EU RoHS exemption.

**Green:** TI defines "Green" to mean the content of Chlorine (Cl) and Bromine (Br) based flame retardants meet JS709B low halogen requirements of  $\leq 1000$ ppm threshold. Antimony trioxide based flame retardants must also meet the  $\leq 1000$ ppm threshold requirement.

(3) MSL, Peak Temp. - The Moisture Sensitivity Level rating according to the JEDEC industry standard classifications, and peak solder temperature.

(4) There may be additional marking, which relates to the logo, the lot trace code information, or the environmental category on the device.

(5) Multiple Device Markings will be inside parentheses. Only one Device Marking contained in parentheses and separated by a "~" will appear on a device. If a line is indented then it is a continuation of the previous line and the two combined represent the entire Device Marking for that device.

(6) Lead finish/Ball material - Orderable Devices may have multiple material finish options. Finish options are separated by a vertical ruled line. Lead finish/Ball material values may wrap to two lines if the finish value exceeds the maximum column width.

**Important Information and Disclaimer:** The information provided on this page represents TI's knowledge and belief as of the date that it is provided. TI bases its knowledge and belief on information provided by third parties, and makes no representation or warranty as to the accuracy of such information. Efforts are underway to better integrate information from third parties. TI has taken and continues to take reasonable steps to provide representative and accurate information but may not have conducted destructive testing or chemical analysis on incoming materials and chemicals. TI and TI suppliers consider certain information to be proprietary, and thus CAS numbers and other limited information may not be available for release.

In no event shall TI's liability arising out of such information exceed the total purchase price of the TI part(s) at issue in this document sold by TI to Customer on an annual basis.

## TAPE AND REEL INFORMATION

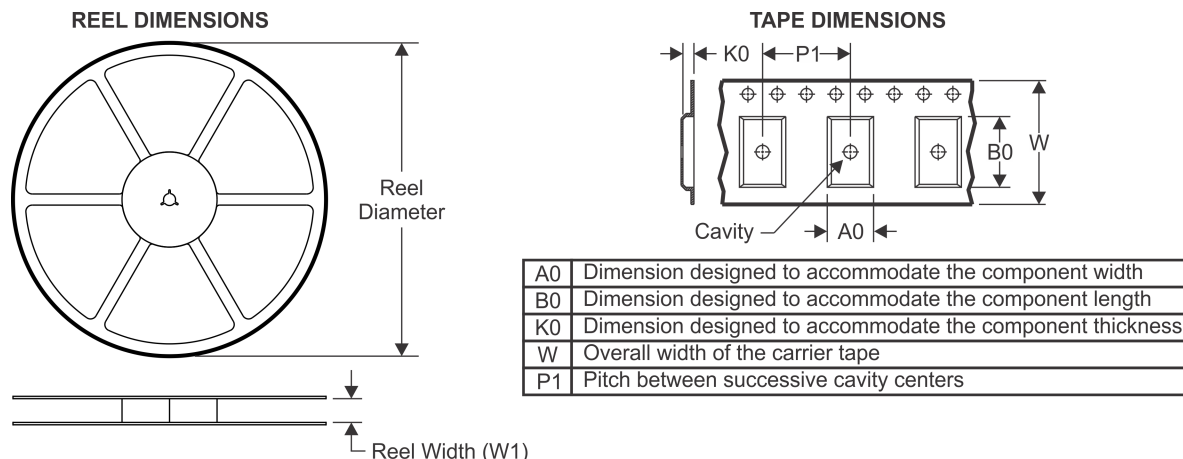

### QUADRANT ASSIGNMENTS FOR PIN 1 ORIENTATION IN TAPE



\*All dimensions are nominal

Device	Package Type	Package Drawing	Pins	SPQ	Reel Diameter (mm)	Reel Width W1 (mm)	A0 (mm)	B0 (mm)	K0 (mm)	P1 (mm)	W (mm)	Pin1 Quadrant
TPS3305-18DGNR	HVSSOP	DGN	8	2500	330.0	12.4	5.3	3.4	1.4	8.0	12.0	Q1
TPS3305-18DR	SOIC	D	8	2500	330.0	12.4	6.4	5.2	2.1	8.0	12.0	Q1
TPS3305-25DGNR	HVSSOP	DGN	8	2500	330.0	12.4	5.3	3.4	1.4	8.0	12.0	Q1
TPS3305-25DR	SOIC	D	8	2500	330.0	12.4	6.4	5.2	2.1	8.0	12.0	Q1
TPS3305-33DGNR	HVSSOP	DGN	8	2500	330.0	12.4	5.3	3.4	1.4	8.0	12.0	Q1
TPS3305-33DR	SOIC	D	8	2500	330.0	12.4	6.4	5.2	2.1	8.0	12.0	Q1

**TAPE AND REEL BOX DIMENSIONS**

\*All dimensions are nominal

Device	Package Type	Package Drawing	Pins	SPQ	Length (mm)	Width (mm)	Height (mm)
TPS3305-18DGNR	HVSSOP	DGN	8	2500	358.0	335.0	35.0
TPS3305-18DR	SOIC	D	8	2500	350.0	350.0	43.0
TPS3305-25DGNR	HVSSOP	DGN	8	2500	358.0	335.0	35.0
TPS3305-25DR	SOIC	D	8	2500	350.0	350.0	43.0
TPS3305-33DGNR	HVSSOP	DGN	8	2500	358.0	335.0	35.0
TPS3305-33DR	SOIC	D	8	2500	350.0	350.0	43.0

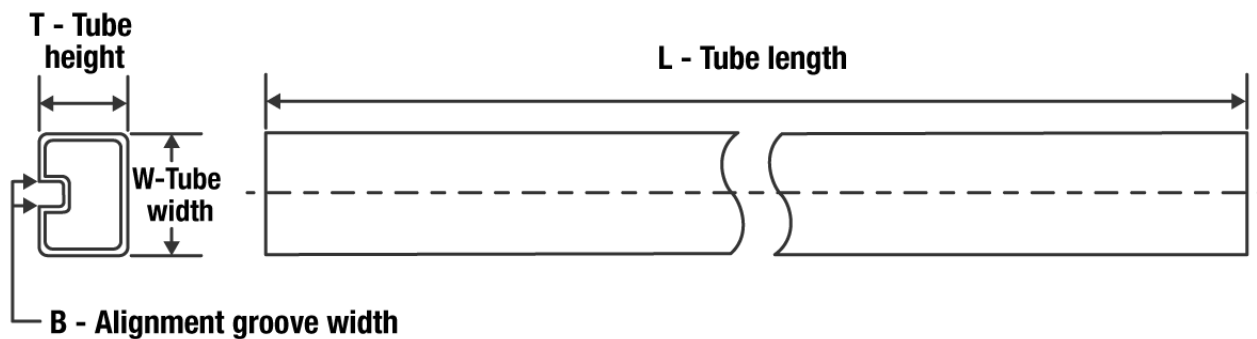
**TUBE**

\*All dimensions are nominal

Device	Package Name	Package Type	Pins	SPQ	L (mm)	W (mm)	T (μm)	B (mm)
TPS3305-18D	D	SOIC	8	75	505.46	6.76	3810	4
TPS3305-18DG4	D	SOIC	8	75	505.46	6.76	3810	4
TPS3305-25D	D	SOIC	8	75	505.46	6.76	3810	4
TPS3305-33D	D	SOIC	8	75	505.46	6.76	3810	4
TPS3305-33DG4	D	SOIC	8	75	505.46	6.76	3810	4

## GENERIC PACKAGE VIEW

**DGN 8**

**PowerPAD VSSOP - 1.1 mm max height**

3 x 3, 0.65 mm pitch

SMALL OUTLINE PACKAGE

This image is a representation of the package family, actual package may vary.  
Refer to the product data sheet for package details.

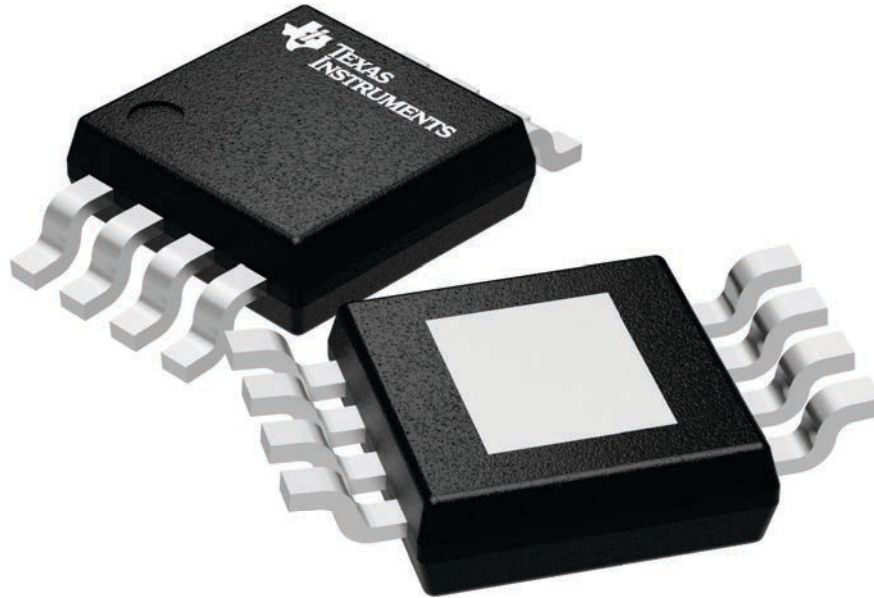

4225482/A

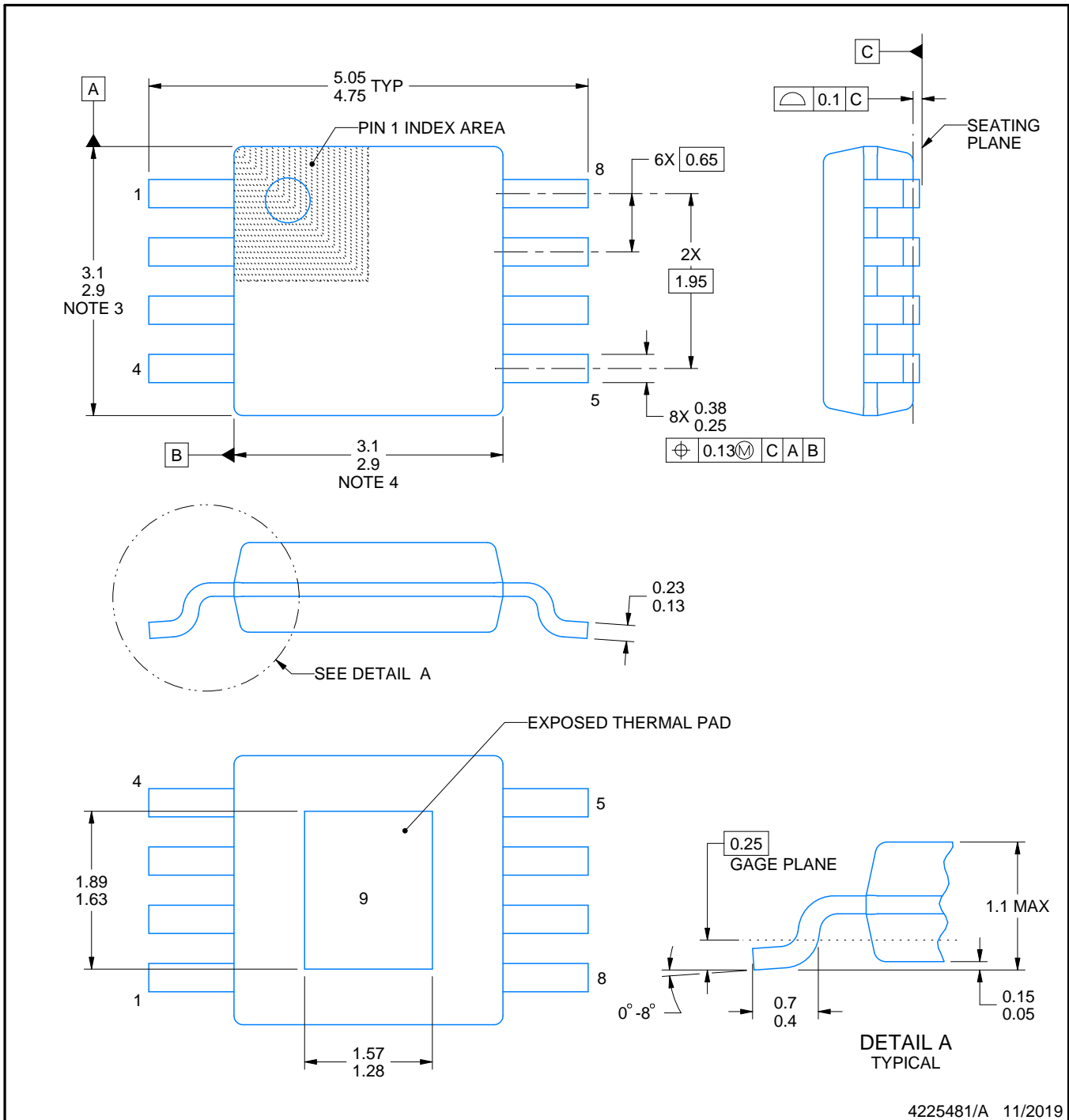
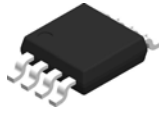

4225481/A 11/2019

PowerPAD is a trademark of Texas Instruments.

NOTES:

1. All linear dimensions are in millimeters. Any dimensions in parenthesis are for reference only. Dimensioning and tolerancing per ASME Y14.5M.
2. This drawing is subject to change without notice.
3. This dimension does not include mold flash, protrusions, or gate burrs. Mold flash, protrusions, or gate burrs shall not exceed 0.15 mm per side.
4. This dimension does not include interlead flash. Interlead flash shall not exceed 0.25 mm per side.
5. Reference JEDEC registration MO-187.

# EXAMPLE BOARD LAYOUT

DGN0008D

PowerPAD™ VSSOP - 1.1 mm max height

SMALL OUTLINE PACKAGE

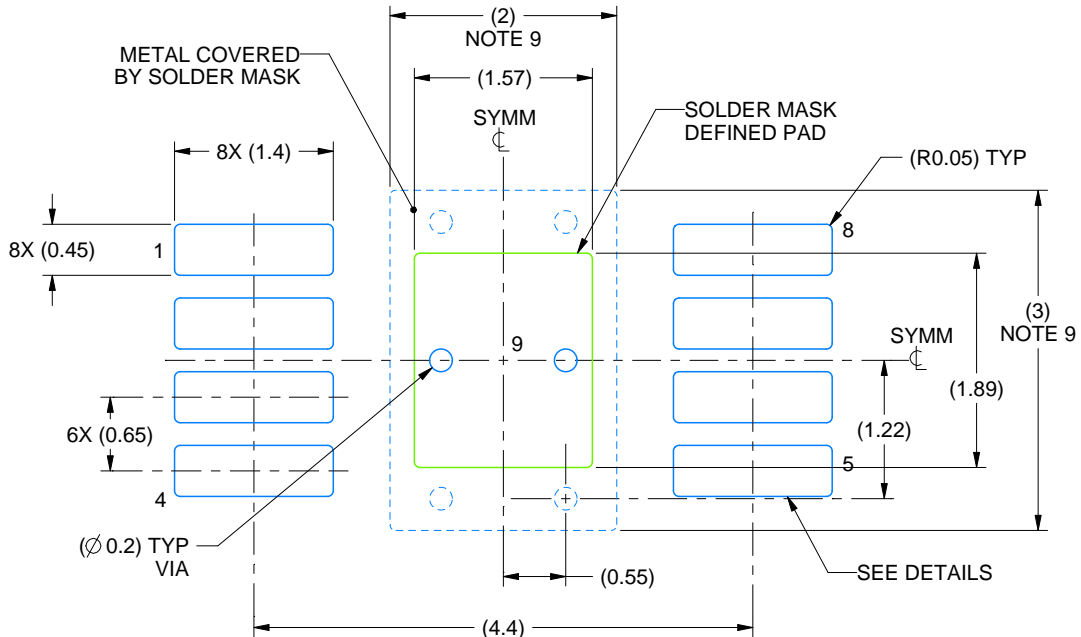

LAND PATTERN EXAMPLE  
EXPOSED METAL SHOWN  
SCALE: 15X

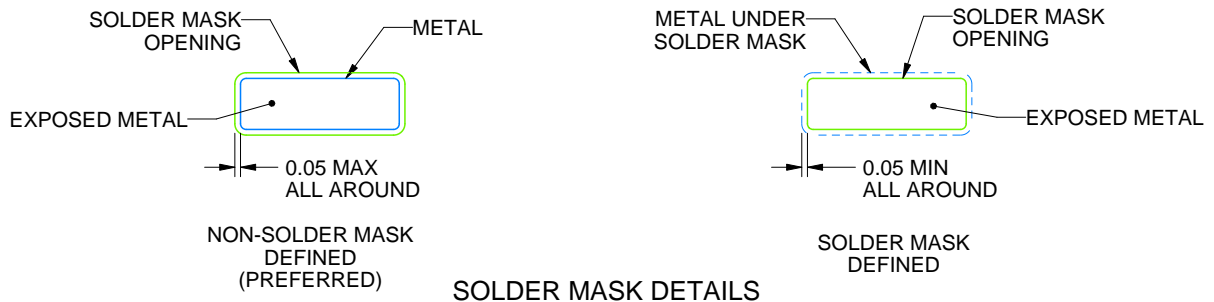

4225481/A 11/2019

NOTES: (continued)

6. Publication IPC-7351 may have alternate designs.
7. Solder mask tolerances between and around signal pads can vary based on board fabrication site.
8. Vias are optional depending on application, refer to device data sheet. If any vias are implemented, refer to their locations shown on this view. It is recommended that vias under paste be filled, plugged or tented.
9. Size of metal pad may vary due to creepage requirement.

# EXAMPLE STENCIL DESIGN

DGN0008D

PowerPAD™ VSSOP - 1.1 mm max height

SMALL OUTLINE PACKAGE

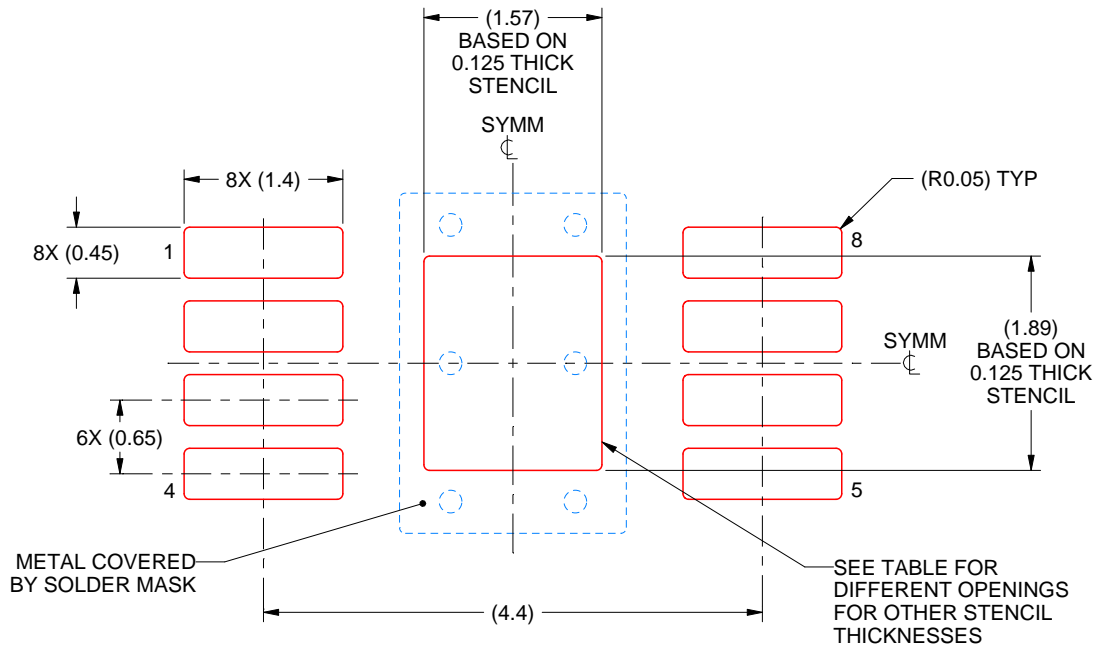

**SOLDER PASTE EXAMPLE**  
EXPOSED PAD 9:  
100% PRINTED SOLDER COVERAGE BY AREA  
SCALE: 15X

STENCIL THICKNESS	SOLDER STENCIL OPENING
0.1	1.76 X 2.11
0.125	1.57 X 1.89 (SHOWN)
0.15	1.43 X 1.73
0.175	1.33 X 1.60

4225481/A 11/2019

NOTES: (continued)

10. Laser cutting apertures with trapezoidal walls and rounded corners may offer better paste release. IPC-7525 may have alternate design recommendations.
11. Board assembly site may have different recommendations for stencil design.





D0008A

# PACKAGE OUTLINE

SOIC - 1.75 mm max height

SMALL OUTLINE INTEGRATED CIRCUIT



4214825/C 02/2019

NOTES:

1. Linear dimensions are in inches [millimeters]. Dimensions in parenthesis are for reference only. Controlling dimensions are in inches. Dimensioning and tolerancing per ASME Y14.5M.
2. This drawing is subject to change without notice.
3. This dimension does not include mold flash, protrusions, or gate burrs. Mold flash, protrusions, or gate burrs shall not exceed  $.006$  [0.15] per side.
4. This dimension does not include interlead flash.
5. Reference JEDEC registration MS-012, variation AA.

# EXAMPLE BOARD LAYOUT

D0008A

SOIC - 1.75 mm max height

SMALL OUTLINE INTEGRATED CIRCUIT



LAND PATTERN EXAMPLE  
EXPOSED METAL SHOWN  
SCALE:8X

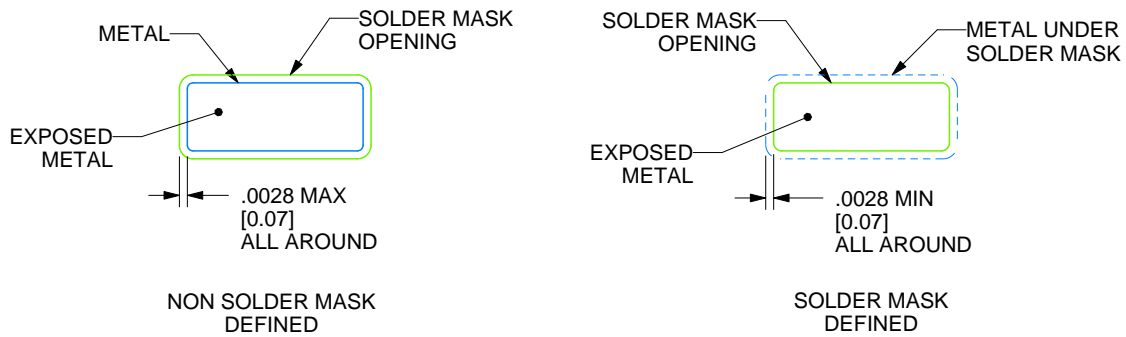

SOLDER MASK DETAILS

4214825/C 02/2019

NOTES: (continued)

- 6. Publication IPC-7351 may have alternate designs.
- 7. Solder mask tolerances between and around signal pads can vary based on board fabrication site.

# EXAMPLE STENCIL DESIGN

D0008A

SOIC - 1.75 mm max height

SMALL OUTLINE INTEGRATED CIRCUIT



SOLDER PASTE EXAMPLE  
BASED ON .005 INCH [0.125 MM] THICK STENCIL  
SCALE:8X

4214825/C 02/2019

NOTES: (continued)

8. Laser cutting apertures with trapezoidal walls and rounded corners may offer better paste release. IPC-7525 may have alternate design recommendations.
9. Board assembly site may have different recommendations for stencil design.

## IMPORTANT NOTICE AND DISCLAIMER

TI PROVIDES TECHNICAL AND RELIABILITY DATA (INCLUDING DATA SHEETS), DESIGN RESOURCES (INCLUDING REFERENCE DESIGNS), APPLICATION OR OTHER DESIGN ADVICE, WEB TOOLS, SAFETY INFORMATION, AND OTHER RESOURCES "AS IS" AND WITH ALL FAULTS, AND DISCLAIMS ALL WARRANTIES, EXPRESS AND IMPLIED, INCLUDING WITHOUT LIMITATION ANY IMPLIED WARRANTIES OF MERCHANTABILITY, FITNESS FOR A PARTICULAR PURPOSE OR NON-INFRINGEMENT OF THIRD PARTY INTELLECTUAL PROPERTY RIGHTS.

These resources are intended for skilled developers designing with TI products. You are solely responsible for (1) selecting the appropriate TI products for your application, (2) designing, validating and testing your application, and (3) ensuring your application meets applicable standards, and any other safety, security, regulatory or other requirements.

These resources are subject to change without notice. TI grants you permission to use these resources only for development of an application that uses the TI products described in the resource. Other reproduction and display of these resources is prohibited. No license is granted to any other TI intellectual property right or to any third party intellectual property right. TI disclaims responsibility for, and you will fully indemnify TI and its representatives against, any claims, damages, costs, losses, and liabilities arising out of your use of these resources.

TI's products are provided subject to [TI's Terms of Sale](#) or other applicable terms available either on [ti.com](https://www.ti.com) or provided in conjunction with such TI products. TI's provision of these resources does not expand or otherwise alter TI's applicable warranties or warranty disclaimers for TI products.

TI objects to and rejects any additional or different terms you may have proposed.

Mailing Address: Texas Instruments, Post Office Box 655303, Dallas, Texas 75265  
Copyright © 2023, Texas Instruments Incorporated