

TPS65233-1 具有 I²C 接口的 LNB 稳压器

1 特性

- 针对 LNB 和 I²C 的完整集成解决方案
- 与数字卫星设备控制 (DiSeqC) 1.x 兼容
- 支持 9V 和 12V 电源总线
- 高达 1000mA 的精确输出电流限值，可通过外部电阻和 I²C 进行调节
- 具有低 R_{ds(on)} 内部电源开关的升压转换器
- 针对非 I²C 应用的专用使能引脚
- 具有推挽输出级的低噪声、低压降输出
- 内置精确 22kHz 音调发生器或外部引脚
- 可调软启动和 13V/18V 电压转换时间
- 符合主要卫星接收器系统规范
- LNB 短路动态保护
- 针对输出电压电平、输入电源欠压闭锁 (UVLO) 和 DiSeqC 音调输出的诊断
- 电缆断开诊断
- 采用 16 引脚 WQFN 3.00mm × 3.00mm (RTE) 封装

2 应用

- 机顶盒卫星接收器
- 电视卫星接收器
- PC 卡卫星接收器

3 说明

TPS65233-1 针对模拟和数字卫星接收器而设计，是一款具有 I²C 接口的单片稳压器，专门为碟形天线内的 LNB 下变频器或卫星多路切换开关盒提供 13V/18V 电源和 22kHz 音调信号。该器件将极少的组件数量，低功率耗散以及简单设计和 I²C 标准接口等特性完美结合，提供了一套完整的解决方案。

TPS65233-1 具备高功率效率。此升压转换器集成了一个以 1MHz 开关频率运行的 120mΩ 功率金属氧化物半导体场效应晶体管 (MOSFET)。线性稳压器中的压降电压为 0.8V，能够最大限度地降低功率损耗。

TPS65233-1 提供了多种方法来生成 22kHz 信号。具有推挽输出级的集成线性稳压器在输出上生成洁净的 22kHz 音调信号，即使在零负载时也是如此。可由外部电阻器以 ±10% 的精度来设定线性稳压器的电流限值。由 I²C 读取的全范围诊断可用于系统监视。

该器件采用 16 引脚 WQFN 3.00mm × 3.00mm (RTE) 封装。

器件信息(1)

器件型号	封装	封装尺寸 (标称值)
TPS65233-1	WQFN (16)	3.00mm x 3.00mm

(1) 要了解所有可用封装，请见数据表末尾的可订购产品附录。

简化电路原理图

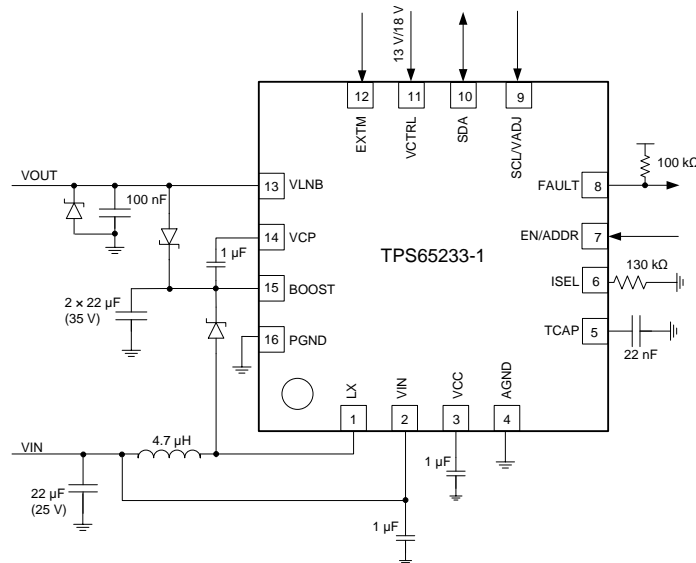

目录

<p>1 特性 1</p> <p>2 应用 1</p> <p>3 说明 1</p> <p>4 修订历史记录 2</p> <p>5 Pin Configuration and Functions 3</p> <p>6 Specifications 4</p> <p> 6.1 Absolute Maximum Ratings 4</p> <p> 6.2 ESD Ratings 4</p> <p> 6.3 Recommended Operating Conditions 4</p> <p> 6.4 Thermal Information 4</p> <p> 6.5 Electrical Characteristics 5</p> <p> 6.6 I²C Interface Timing Requirements 6</p> <p> 6.7 Switching Characteristics 6</p> <p> 6.8 Typical Characteristics 8</p> <p>7 Detailed Description 9</p> <p> 7.1 Overview 9</p> <p> 7.2 Functional Block Diagram 9</p>	<p> 7.3 Feature Description 9</p> <p> 7.4 Device Functional Modes 11</p> <p> 7.5 Programming 14</p> <p> 7.6 Register Map 15</p> <p>8 Application and Implementation 18</p> <p> 8.1 Application Information 18</p> <p> 8.2 Typical Application 18</p> <p>9 Power Supply Recommendations 22</p> <p>10 Layout 22</p> <p> 10.1 Layout Guidelines 22</p> <p> 10.2 Layout Example 22</p> <p>11 器件和文档支持 23</p> <p> 11.1 社区资源 23</p> <p> 11.2 商标 23</p> <p> 11.3 静电放电警告 23</p> <p> 11.4 术语表 23</p> <p>12 机械、封装和可订购信息 23</p>
---	--

4 修订历史记录

注：之前版本的页码可能与当前版本有所不同。

日期	修订版本	注释
2015 年 9 月	*	最初发布版本。

5 Pin Configuration and Functions

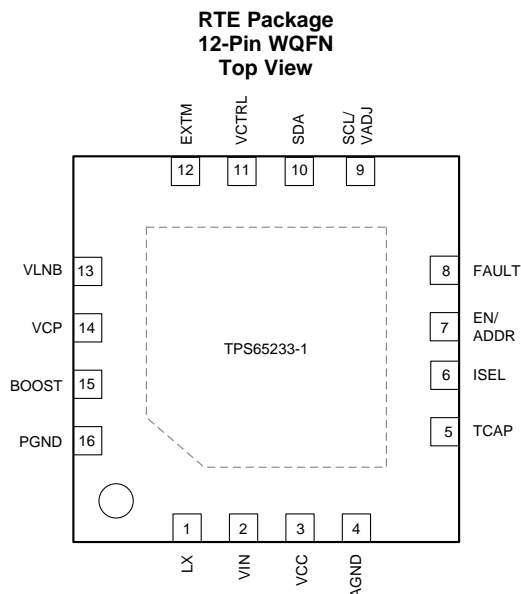

Exposed pad must be soldered to PCB for optimal thermal performance.

Pin Functions

PIN		DESCRIPTION
NAME	NUMBER	
AGND	4	Analog ground. Connect all ground pins and power pad together.
BOOST	15	Output of the boost regulator and input voltage of the internal linear regulator
EN/ADDR	7	Enable pin to enable the whole chip; pull to ground to disable output, output will be pulled to ground. For I ² C interface, pulling this pin high or low gives different I ² C addresses.
EXTM	12	External modulation logic input pin which activates the 22-kHz tone output, feeding signal can be 22-kHz tone or logic high or low.
FAULT	8	This pin is an open drain output pin, it goes low if any fault flag is set.
ISEL	6	Connect a resistor to this pin to set the LNB output current limit.
LX	1	Switching node of the boost converter
PGND	16	Power ground for boost converter
SCL/VADJ	9	I ² C compatible clock input; if I ² C function is not used, connect this pin to low set output voltage 13 V/18 V, connect to high set output voltage 13.4 V/18.6 V
SDA	10	I ² C compatible bi-directional data
TCAP	5	Connect a capacitor to this pin to set the rise time and fall time of the LNB output between 13 V and 18 V.
VCC	3	Internal 6.5-V power supply bias. Connect a 1- μ F ceramic capacitor from this pin to ground. When V _{IN} is 5 V, connect VCC to V _{IN} .
VCP	14	Gate drive supply voltage, output of charge pump, connect a capacitor between this pin to pin BOOST.
VCTRL	11	Logic control pin for 13-V or 18-V voltage selection at LNB output
VIN	2	Input of internal linear regulator
VLNB	13	Output of the LNB power supply connected to satellite receiver or switch
Thermal pad	—	Must be soldered to PCB for optimal thermal performance. Have thermal vias on the PCB to enhance power dissipation.

6 Specifications

6.1 Absolute Maximum Ratings

over operating free-air temperature range, all voltages are with respect to GND (unless otherwise noted)⁽¹⁾

		MIN	MAX	UNIT
Voltage	VIN, LX, BOOST, VLNB	-1	30	V
	VCP		BOOST + 7	
	LX	-1	30	
	VCC, EN, FAULT, SCL, SDA, VCTRL, ISEL, EXTM	-0.3	7	
	TCAP	-0.3	3.6	
	PGND, AGND	-0.3	0.3	
Operating junction temperature, T _J		-40	125	°C
Storage temperature, T _{stg}		-55	150	°C

- (1) Stresses beyond those listed under *Absolute Maximum Ratings* may cause permanent damage to the device. These are stress ratings only, which do not imply functional operation of the device at these or any other conditions beyond those indicated under *Recommended Operating Conditions*. Exposure to absolute-maximum-rated conditions for extended periods may affect device reliability.

6.2 ESD Ratings

		VALUE	UNIT
V _(ESD)	Electrostatic discharge		V
	Human body model (HBM), per ANSI/ESDA/JEDEC JS-001, other pins ⁽¹⁾	2000	
	Human body model (HBM), per ANSI/ESDA/JEDEC JS-001, pin 13 (VLNB) ⁽¹⁾	6000	
	Charged device model (CDM), per JEDEC specification JESD22-C101, all pins ⁽²⁾	500	

- (1) JEDEC document JEP155 states that 500-V HBM allows safe manufacturing with a standard ESD control process.
 (2) JEDEC document JEP157 states that 250-V CDM allows safe manufacturing with a standard ESD control process.

6.3 Recommended Operating Conditions

over operating free-air temperature range (unless otherwise noted)

		MIN	NOM	MAX	UNIT
VIN	Input operating voltage	4.5		20	V
T _A	Junction temperature	-40		85	°C

6.4 Thermal Information

THERMAL METRIC ⁽¹⁾		TPS65233-1	UNIT
		RTE (WQFN)	
		16 PINS	
R _{θJA}	Junction-to-ambient thermal resistance	43.4	°C/W
R _{θJC(top)}	Junction-to-case (top) thermal resistance	45.6	°C/W
R _{θJB}	Junction-to-board thermal resistance	15	°C/W
ψ _{JT}	Junction-to-top characterization parameter	0.6	°C/W
ψ _{JB}	Junction-to-board characterization parameter	15	°C/W
R _{θJC(bot)}	Junction-to-case (bottom) thermal resistance	3.3	°C/W

- (1) For more information about traditional and new thermal metrics, see the *Semiconductor and IC Package Thermal Metrics* application report, [SPRA953](#).

6.5 Electrical Characteristics

 $T_J = -40^{\circ}\text{C}$ to 125°C , $V_{IN} = 12\text{ V}$, $f_{SW} = 1\text{ MHz}$ (unless otherwise noted)

PARAMETER		TEST CONDITIONS	MIN	TYP	MAX	UNIT
INPUT SUPPLY						
V_{IN}	Input voltage range	V_{IN}	4.5	12	20	V
I_{DDSDN}	Shutdown supply current	$EN = 0$		160		μA
I_{DDQ}	LDO input quiescent current	$EN = 1$, $I_{OUT} = 0\text{ A}$, $V_{BOOST} = 14\text{ V}$, $I_{LNB} = 0\text{ mA}$		10.5		mA
$UVLO$	V_{IN} under voltage lockout	Rising V_{IN}	4.05	4.25	4.45	V
		Falling V_{IN}	3.6	3.8	4.1	
		Hysteresis		450		mV
OUTPUT VOLTAGE						
V_{OUT}	Regulated output voltage (non-I ² C mode)	$VCTRL = 1$, $SCL = 0$, $I_{OUT} = 500\text{ mA}$		18		V
		$VCTRL = 1$, $SCL = 1$, $I_{OUT} = 500\text{ mA}$	18.2	18.6	19	
		$VCTRL = 0$, $SCL = 0$, $I_{OUT} = 500\text{ mA}$		13		
		$VCTRL = 0$, $SCL = 1$, $I_{OUT} = 500\text{ mA}$	13.1	13.4	13.7	
$V_{LINEREG}$	Line regulation-DC	$V_{IN} = 7.5\text{ V}$ to 16 V , $I_{OUT} = 500\text{ mA}$		0.2		%/V
$V_{LOADREG}$	Load regulation-DC	$I_{OUT} = (10\text{-}90\%) \times I_{OUTMAX}$		0.7		%/A
$IOCP$	Output short circuit current limit	$R_{SEL} = 200\text{ k}\Omega$, $T_J = 25^{\circ}\text{C}$	580	650	720	mA
T_r , T_f	13-V/18-V transition rising/falling time	$C_{TCAP} = 5.6\text{ nF}$		0.33		ms
f_{SW}	Boost switching frequency			1040		kHz
$I_{limitsw}$	Switching current limit	$V_{IN} = 12\text{ V}$, $V_{OUT} = 18.6\text{ V}$		3.2		A
R_{dson_LS}	On resistance of low side FET on CH	$V_{IN} = 12\text{ V}$		120		m Ω
V_{drop}	Linear regulator voltage drop-out	$I_{OUT} = 500\text{ mA}$		0.8		V
I_{rev}	Reverse bias current	$EN = 1$, $V_{LNB} = 21\text{ V}$		50		mA
I_{rev_dis}	Disabled reverse bias current	$EN = 0$, $V_{LNB} = 21\text{ V}$		3		mA
LOGIC SIGNALS						
V_{EN}	Enable threshold level			1.15		V
V_{ENH}	Enable threshold level hysteresis			80		mV
V_{LOGICH} , V_{LOGICI}	$VCTRL$, $EXTM$ Logic threshold level	High level input voltage	2			V
		Low level input voltage			0.8	
V_{OL_FAULT}	FAULT output low voltage	FAULT open drain, $I_{OL} = 1\text{ mA}$			0.4	V
f_{I2C}	Maximum I ² C clock frequency		400			kHz
TONE						
f_{tone}	Tone frequency		20	22	24	kHz
A_{tone}	Tone amplitude	$I_{OUT} = 0\text{ mA}$ to 500 mA , $C_{OUT} = 100\text{ nF}$	550	680	750	mV
D_{tone}	Tone duty cycle		45%	50%	55%	
PROTECTION						
TON	Over current protection on time			4		ms
$TOFF$	Over current protection off time			128		ms
THERMAL SHUTDOWN						
T_{TRIP}	Thermal shut down trip point	Rising temperature		160		$^{\circ}\text{C}$
T_{HYST}	Thermal shut down hysteresis			20		$^{\circ}\text{C}$

Electrical Characteristics (continued)

 $T_J = -40^{\circ}\text{C}$ to 125°C , $V_{IN} = 12\text{ V}$, $f_{SW} = 1\text{ MHz}$ (unless otherwise noted)

PARAMETER		TEST CONDITIONS	MIN	TYP	MAX	UNIT
I²C READ BACK FAULT STATUS						
V _{PGOOD}	PGOOD trip levels	Feedback voltage low side rising		95.3%		
		Feedback voltage low side falling		94.7%		
		Feedback voltage high side rising		105.3%		
		Feedback voltage high side falling		104.7%		
T _{warn}	Temperature warning threshold		125			°C
I²C INTERFACE						
V _{IH}	SDA,SCL input high voltage		2			V
V _{IL}	SDA,SCL input low voltage				0.8	V
I _I	Input current	SDA, SCL, V _I = 0.4 V to 4.5 V	-10		10	μA
V _{OL}	SDA output low voltage	SDA open drain, I _{OL} = 2 mA			0.4	V
f _(SCL)	Maximum SCL clock frequency		400			kHz
C _B	Capacitance of one bus line (SCL and SDA)				400	pF

6.6 I²C Interface Timing Requirements

		MIN	MAX	UNIT
t _{BUF}	Bus free time between a STOP and START condition	1.3		μs
t _{HD, STA}	Hold time (Repeated) START condition	0.6		μs
t _{SU, STO}	Setup time for STOP condition	0.6		μs
t _{LOW}	LOW period of the SCL clock	1.3		μs
t _{HIGH}	HIGH period of the SCL clock	0.6		μs
t _{SU, STA}	Setup time for a repeated START condition	0.6		μs
t _{SU, DAT}	Data setup time	0.1		μs
t _{HD, DAT}	Data hold time	0	0.9	μs
t _{RCL}	Rise time of SCL signal	20 + 0.1C _B	300	ns
t _{RCL1}	Rise time of SCL signal after a repeated START condition and after an acknowledge BIT	20 + 0.1C _B	300	ns
t _f	Fall time of SCL signal	20 + 0.1C _B	300	ns
t _r	Rise time of SDA signal	20 + 0.1C _B	300	ns
t _{FDA}	Fall time of SDA signal	20 + 0.1C _B	300	ns

6.7 Switching Characteristics

over operating free-air temperature range (unless otherwise noted)

PARAMETER		TEST CONDITIONS	MIN	TYP	MAX	UNIT
OUTPUT VOLTAGE						
T _r , T _f	13-V/18-V Transition rising falling time	C _{cap} = 5.6 nF		0.33		ms
tone						
T _{rtone}	Tone rise time	I _{OUT} = 0 to 500 mA, C _{OUT} = 100 nF		10		μs
T _{ftone}	Tone fall time	I _{OUT} = 0 to 500 mA, C _{OUT} = 100 nF		10		μs

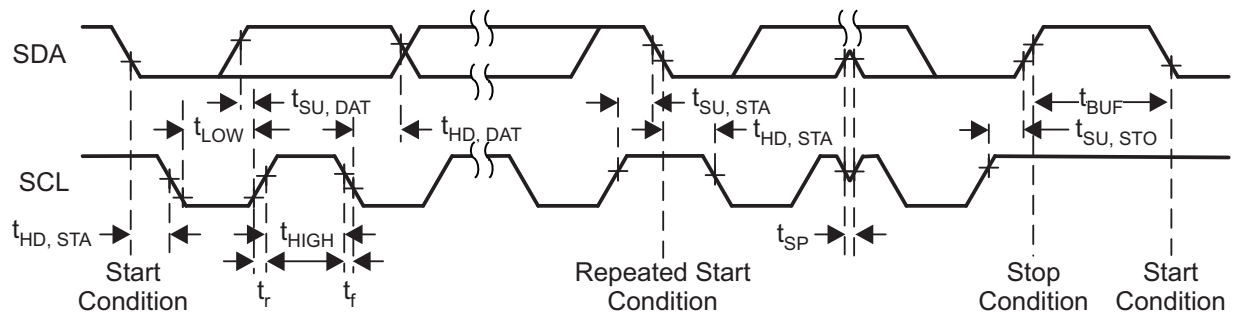

Figure 1. I²C Interface Timing Diagram

6.8 Typical Characteristics

$T_A = 25^\circ\text{C}$, $V_{IN} = 12\text{ V}$, $f_{SW} = 1\text{ MHz}$, $L = 4.7\ \mu\text{H}$, $C_{Boost} = 2 \times 22\ \mu\text{F}/35\text{ V}$ (unless otherwise noted)

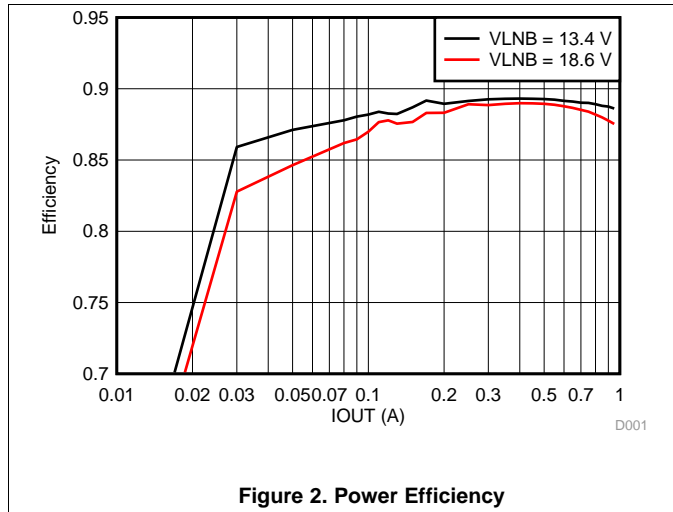

Figure 2. Power Efficiency

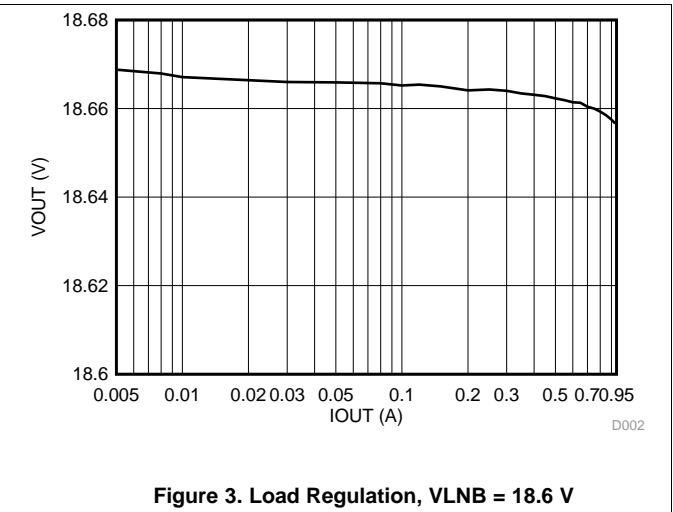

Figure 3. Load Regulation, VLNB = 18.6 V

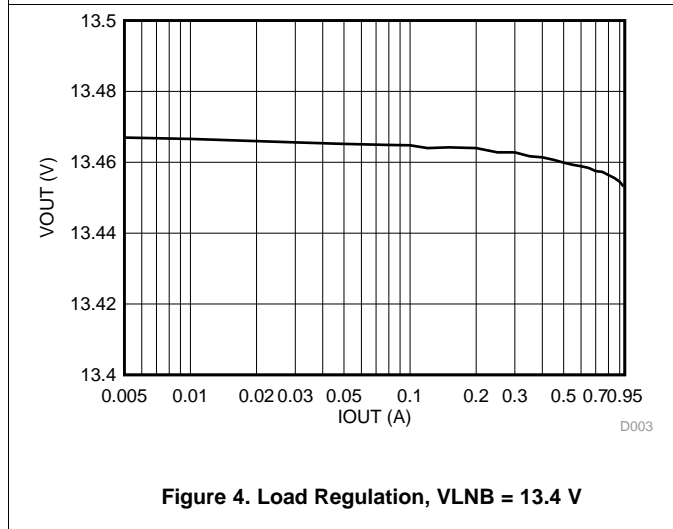

Figure 4. Load Regulation, VLNB = 13.4 V

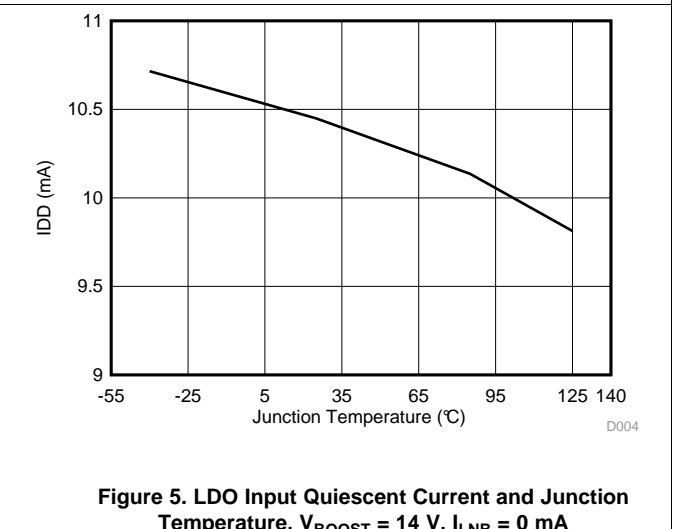

Figure 5. LDO Input Quiescent Current and Junction Temperature, $V_{BOOST} = 14\text{ V}$, $I_{LNB} = 0\text{ mA}$

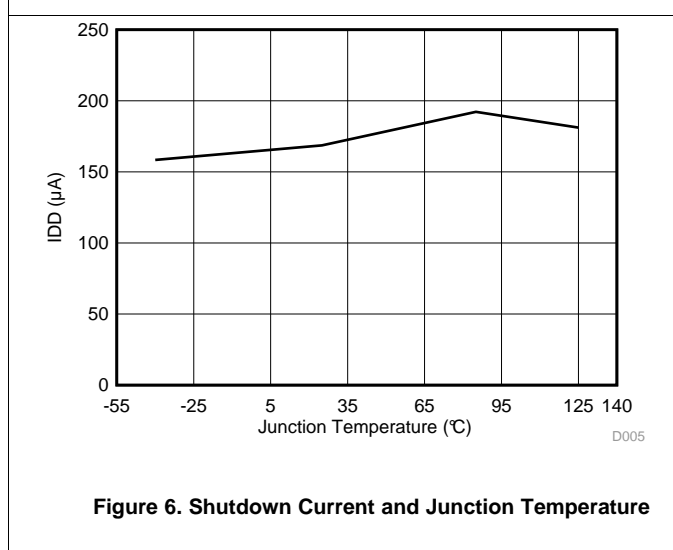

Figure 6. Shutdown Current and Junction Temperature

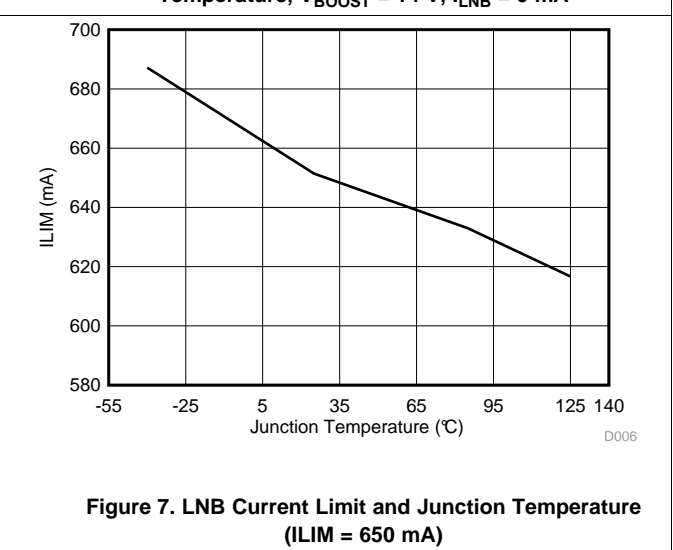

Figure 7. LNB Current Limit and Junction Temperature (ILIM = 650 mA)

7 Detailed Description

7.1 Overview

The TPS65233-1 is a power management IC that integrates a boost converter, a LDO, and a 22-kHz tone generator that serves as a LNB power supply. This solution compiles the DiSEqC 1.x standard with or without I²C interface. Output current can be precisely programmed by an external resistor. There are five ways to generate the 22-kHz tone signal with or without I²C. Integrated boost features low R_{dson} MOSFET and internal compensation. A fixed 1-MHz switching frequency is designed to reduce components size.

7.2 Functional Block Diagram

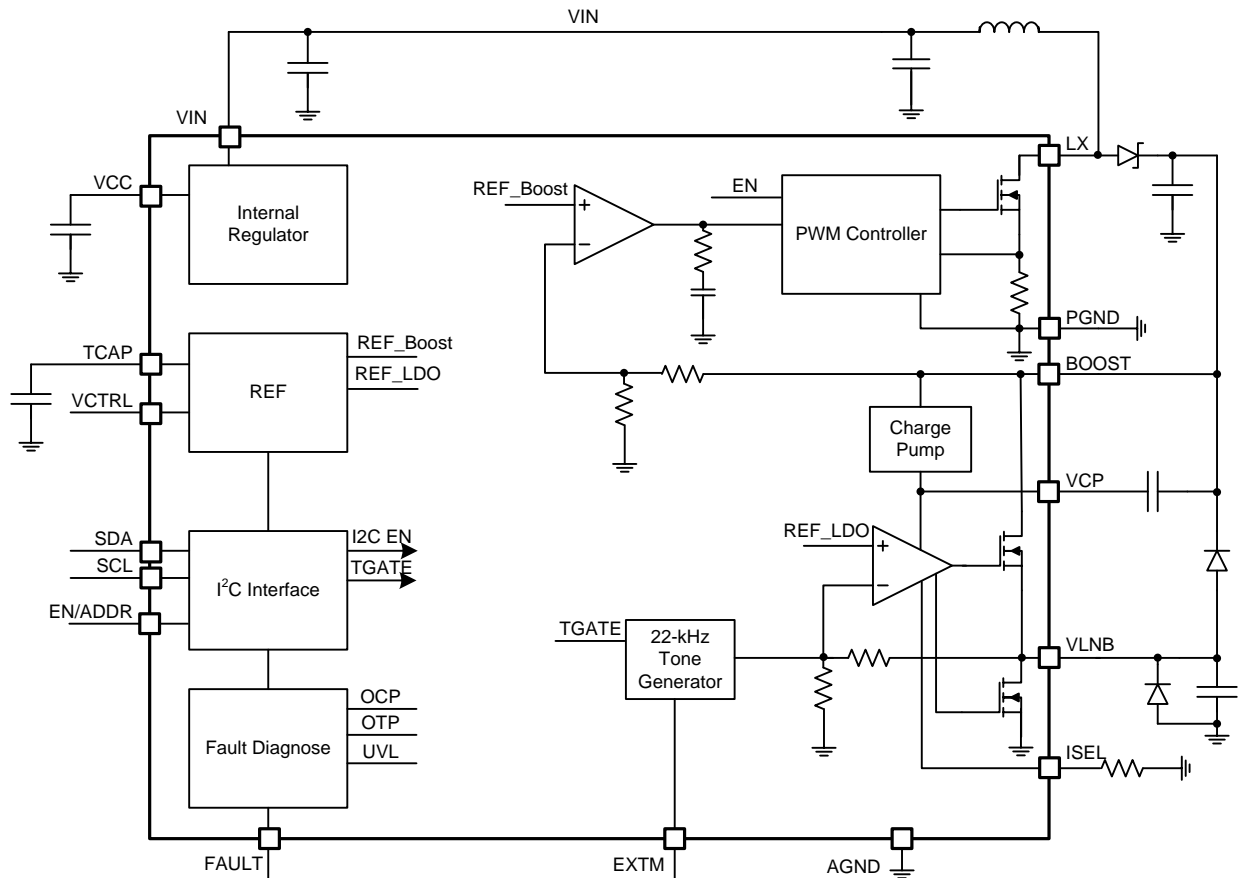

7.3 Feature Description

7.3.1 Boost Converter

The TPS65233-1 consists of an internal compensated boost converter and linear regulator. The boost converter tracks the output LNB voltage to within 800 mV even at loading 950 mA, to minimize power dissipation. Under conditions where the input voltage, VBOOST, is greater than the output voltage, VLNB, the linear regulator must drop the differential voltage. When operating in these conditions, taken care to ensure that the safe operating temperature range of the TPS65233-1 is not exceeded. The boost converter operates at 1 MHz typical. The TPS65233-1 has internal pulse-by-pulse current limiting on the boost converter and DC current limiting on the LNB output to protect the IC against short circuits. When the LNB output is shorted, the LNB output current is limited. The current limit is set by the external resistor. And the IC will be shut down if the overcurrent condition lasts for more than 4 ms, the converter enters hiccup mode and will retry startup in 128 ms. At extremely light loads, the boost converter operates in a pulse-skipping mode.

Feature Description (continued)

If two or more set top box LNB outputs are connected together, one output voltage could be set higher than others. The output with lower set voltage would be effectively turned off. Once the voltage drops to the set level, the LNB output with lower set output voltage will return to normal conditions.

7.3.2 Linear Regulator and Current Limit

The linear regulator is used to generate the 22-kHz tone signal by changing the reference voltage. The linear regulator features low drop out voltage to minimize power loss while keeping enough head room for the 0.68-V, 22-kHz tone. It also implements a tight current limit for over current protection. The current limit is set by an external resistor connected to the ISEL pin. The curve below shows the relationship between the current limit threshold and the resistor value.

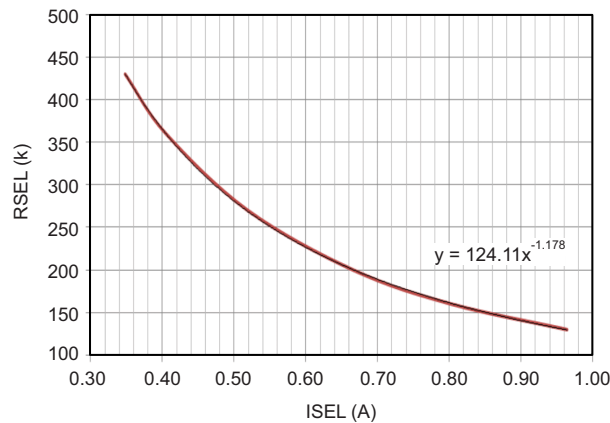

Figure 8. Linear Regulator Current Limit vs Resistor

$$R_{SEL} \text{ (k}\Omega\text{)} = 124.11 \times I_{SEL}^{-1.178} \text{ (A)} \quad (1)$$

A 280-kΩ resistor sets the current to 0.5 A. The current limit can also be set by I²C through a register.

7.3.3 Charge Pump

The charge pump circuitry generates a voltage to drive the NMOS of the linear regulator. One end the charge pump capacitor is connected to the output of the boost converter. The voltage on the charge pump capacitor is about 6.25 V.

7.3.4 Slew Rate Control

When LNB output voltage transits from 13 V to 18 V or vice versa, the capacitor at pin TCAP controls the transition time. This transition is to make sure the boost converter can follow the voltage change. Usually boost converter has low bandwidth and can't response fast. The voltage at TCAP acts as the reference voltage of the linear regulator. The boost converter's reference is also based on TCAP with additional fixed voltage to generate 0.8 V above the output.

The charging and discharging current is 10 μA, thus the transition time can be calculated as:

$$T_{cad} \text{ (ms)} = 0.5 \times \frac{C_{ss} \text{ (nF)}}{I_{ss} \text{ (}\mu\text{A)}} \quad (2)$$

A 22-nF capacitor generates a 1.1-ms transition time.

In light load conditions, when LNB output voltage is set from 18 to 13 V, the voltage might drops very slow, which might cause wrong logic detection at LNB side. The TPS65233-1 has an integrated pull down circuit to pull down the output during the transition. This ensures the voltage change can follow the voltage at TCAP. Meanwhile, when the 22-kHz tone signal is superimposing on the LNB output voltage, the pull down current can also provide a square wave instead of distorted waveforms, which could cause another detection problem.

Feature Description (continued)

7.3.5 Short Circuit Protection, Hiccup, and Overtemperature Protection

The LNB output limit can be set by an external resistor. When short circuit conditions occur, the output current is clamped at the current limit for 4 ms. If the condition remains, the converter will shut down for 128 ms and then try restart. This hiccup behavior prevents the IC from overheating.

The low side MOSFET of the boost converter has a current limit threshold at 3.2 A, which serves as secondary protection. If the boost converter's peak current limit is triggered, the peak current will clamp at 3.2 A. If loading current continues to increase, output voltage starts to drop and output power drops.

Thermal shutdown prevents the chip from operating at exceedingly high temperatures. When the silicon die temperature exceeds 160°C, the output shuts down. When the temperature drops below its lower threshold, typically 140°C, the output is enabled.

When the chip is in over current protection or thermal shutdown, the I²C interface and some logic are still active. The Fault pin is pulled down to signal the processor. The Fault pin signal will remain low unless the following actions are taken:

1. If I²C interface is not used to control, Enable pin must be recycled in order to pull Fault pin back to high.
2. If I²C interface is used, the I²C master needs to read the OCP or OTP bit in the register, then the Fault pin returns to high.

7.4 Device Functional Modes

7.4.1 Tone Generation

A 22-kHz tone signal is superimposed at the LNB output voltage as a carrier for DiSEqC command. This tone signal can be generated by feeding an external 22-kHz clock at the EXTM pin. It can also be generated with its internal tone generator gated by control logic. The output stage of the regulator facilitates a push-pull circuit, so even at zero loading the 22-kHz tone at the output is still clear of distortion.

There are five ways to generate the 22-kHz tone signal at the output.

In non-I²C mode, only option 1 and option 2 are supported in TPS65233-1. EXTM can be tone envelope or 22 kHz burst pulse as shown in [Figure 9](#). Option 3 and option 4 are designed for I²C interface communication mode. In I²C communication mode, TGATE bit must be written through I²C bus. If there is no bandwidth of I²C bus to write TGATE bit, there is a supplemental option 5 to generate 22-kHz tone, as shown in [Figure 10](#). In option 5, bit TMODE and TGATE must be set as 1.

Device Functional Modes (continued)

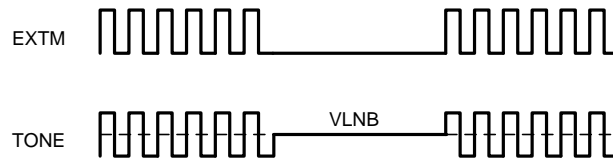

Option 1, Non-I²C Mode, bit I2C_CON = 0

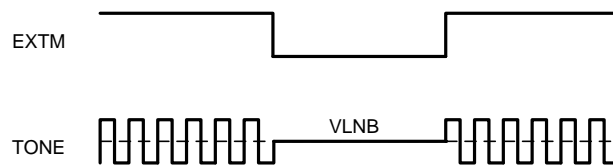

Option 2, Non-I²C Mode, bit I2C_CON = 0

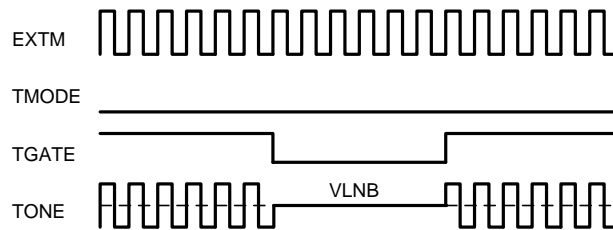

Option 3, I²C Mode, bit I2C_CON = 1 and TMODE = 0

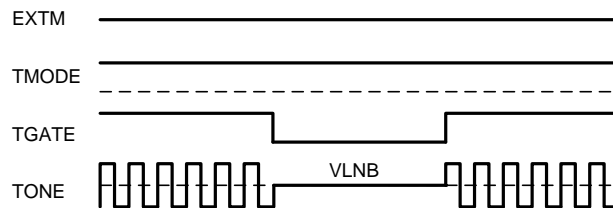

Option 4, I²C Mode, EXTM = 0, bit I2C_CON = 1, and TMODE = 1

Figure 9. Four Ways to Generate 22-kHz Tone

Device Functional Modes (continued)

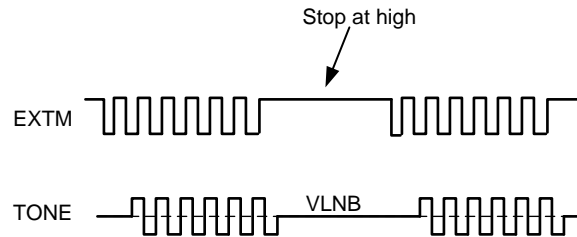

Option 5: I²C Mode, gated by EXTM, TMODE, and TGATE = 1

Figure 10. Supplemental Option for 22-kHz Tone in I²C Mode

7.4.2 Serial Interface

I²C is a 2-wire serial interface developed by Philips Semiconductor (see I²C-Bus Specification, Version 2.1, January 2000). The bus consists of a data line (SDA) and a clock line (SCL) with pull-up structures. When the bus is idle, both SDA and SCL lines are pulled high. All the I²C compatible devices connect to the I²C bus through open drain I/O pins, SDA and SCL. A master device, usually a microcontroller or a digital signal processor, controls the bus. The master is responsible for generating the SCL signal and device addresses. The master also generates specific conditions that indicate the START and STOP of data transfer. A slave device receives and transmits data on the bus under control of the master device.

The TPS65233-1 device works as a slave and supports the following data transfer modes, as defined in the I²C-Bus Specification: standard mode (100 kbps), and fast mode (400 kbps). The interface adds flexibility to the power supply solution, enabling most functions to be programmed to new values depending on the instantaneous application requirements. Register contents remain intact as long as supply voltage remains above 4.5 V (typical).

The data transfer protocol for standard and fast modes is exactly the same; therefore, they are referred to as F/S-mode in this document. The TPS65233-1 device supports 7-bit addressing; 10-bit addressing and general call address are not supported.

The TPS65233-1 device has a 7-bit address with the 2 LSB bits set by EN pin. Connecting EN to ground set the address 0x60H, connecting to high set the address 0x61H.

Table 1. I²C Address Selection

EN/ADDR PIN	I ² C ADDRESS	ADDRESS FORMAT (A6...A0)
Connect to ground	0x60H	110 0000
Connect to high	0x61H	110 0001

7.5 Programming

7.5.1 I²C Update Sequence

The TPS65233-1 requires a start condition, a valid I²C address, a register address byte, and a data byte for a single update. After the receipt of each byte, the TPS65233-1 device acknowledges by pulling the SDA line low during the high period of a single clock pulse. The TPS65233-1 performs an update on the falling edge of the LSB byte.

When the TPS65233-1 is disabled (EN pin tied to ground) the device can still be updated via the I²C interface.

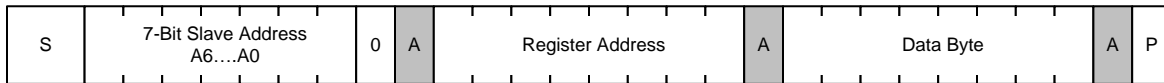

Figure 11. I²C Write Data Format

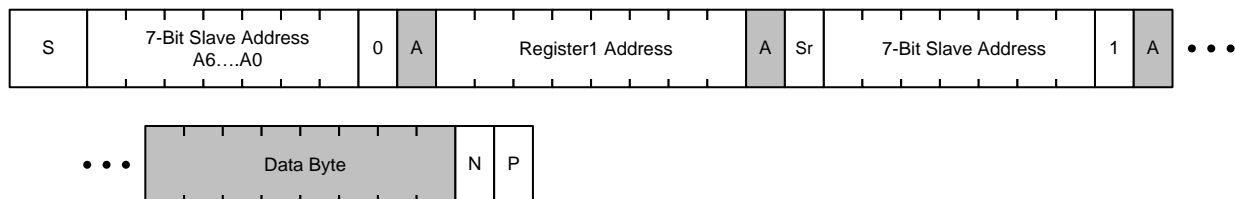

Figure 12. I²C Read Data Format

- A: Acknowledge
- N: Not Acknowledge
- S: Start
- P: Stop
- Sr: Repeated Start
- System Host
- Chip

Figure 13. Legend

7.6 Register Map

The registers are listed in [Table 2](#) and described in the following sections.

Table 2. Register Map

REGISTER / ADDRESS	7	6	5	4	3	2	1	0
Control Register 1 Address: 0x00H	I2C_CON	Reserved	TGATE	TMODE	EN	VSEL2	VSEL1	VSEL0
Control Register 2 Address: 0x01H	—	—	—	TONE_ POS1	TONE_ POS0	CL1	CL0	CL_EXT
Status Register 1 Address: 0x02H	—	T125	LDO_ON	Reserved	TSD	OCP	CABLE_ GOOD	VOUT_ GOOD

7.6.1 Control Register 1 - Address: 0x00H

Table 3. Control Register 1 - Address: 0x00H

BIT	FIELD	TYPE	RESET	DESCRIPTION
7	I2C_CON	R/W	0	1: I ² C control enabled; 0: I ² C control disabled
6	Reserved	R/W	0	Reserved
5	TGATE	R/W	0	Tone Gate. Allows either the internal or external 22-kHz tone signals to be gated. 1: Tone Gate on use; 0: Tone gate off
4	TMODE	R/W	0	Tone mode. Select between the use of an external 22-kHz or internal 22-kHz signal. 1: internal; 0: external
3	EN	R/W	1	LNB output voltage Enable 1: output enabled; 0: output disabled
2	VSEL2	R/W	0	See Table 4 for output voltage selection
1	VSEL1	R/W	0	
0	VSEL0	R/W	0	

Table 4. Voltage Selection Bits

VSEL2	VSEL1	VSEL0	LNB(V)
0	0	0	13
0	0	1	13.4
0	1	0	13.8
0	1	1	14.2
1	0	0	18
1	0	1	18.6
1	1	0	19.2
1	1	1	19.8

7.6.2 Control Register 2 - Address: 0x01H

Table 5. Control Register 2 - Address: 0x01H

BIT	FIELD	TYPE	RESET	DESCRIPTION
7	—	R/W	—	—
6	—	R/W	—	—
5	—	R/W	—	—

Table 5. Control Register 2 - Address: 0x01H (continued)

BIT	FIELD	TYPE	RESET	DESCRIPTION
4	TONE_POS1	R/W	0	00: tone above Vout; 01: tone in the middle of Vout; 10: tone below Vout
3	TONE_POS0	R/W	1	
2	CL1	R/W	0	
1	CL0	R/W	0	Current limit set bits
0	CL_EXT	R/W	1	1: current limit set by external resistor; 0: current limit set by register

Some tone detection circuits in LNB are sensitive to the position of the tone on the output voltage. The TPS65233-1 provides options to select the position by setting the TONE_POS1 and TONE_POS0 bits, as illustrated below.



Option 1, TONE_POS1=0, TONE_POS0=0, Tone above VLNB

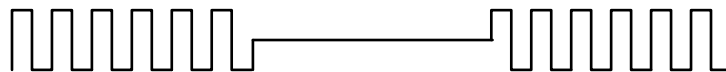

Option 2, TONE_POS1=0, TONE_POS0=1, Tone in the middle of VLNB



Option 2, TONE_POS1=1, TONE_POS0=0, Tone below VLNB

Figure 14. Tone Position Programmed by TONE_POS1, TONE_POS0 Bits

In addition to programming the LDO's current continuously via an external resistor, internal registers also provide options to program the current limit. There are four options that can be selected.

Table 6. Current Limit Selection Bits

CL1	CL0	CURRENT LIMIT (mA)
0	0	400
0	1	600
1	0	750
1	1	1000

7.6.3 Status Register 1 - Address: 0x02H

The TPS65233-1 has a full range of diagnostic flags for operation and debug. If any of the flags are triggered, the FAULT pin is pulled low sending an interrupt signal to processor. The processor then can read the status register to check the error conditions. The status bits are described in the following table. Among these bits, TSD and OCP are different from the others. Once TSD and OCP are set to 1, the FAULT pin logic is latched low and the processor must reset the bits in order to release the fault conditions. Other bits change as conditions change without latch.

Table 7. Status Register 1 - Address: 0x02H

BIT	FIELD	TYPE	RESET	DESCRIPTION
7	—	—	—	—
6	T125	R	0	1: if die temperature T > 125°C; 0: if die temperature T < 125°C
5	LDO_ON	R	0	1: internal LDO is turned on and boost converter is on; 0: Internal LDO is turned off but boost converter is on
4	Reserved	R	0	Reserved
3	TSD	R	0	1: thermal shutdown occurs; 0: thermal shutdown does not occur. FAULT pin pull low and latch, I ² C master need to read and release
2	OCP	R	0	Overcurrent protection. If over current conditions last for more than 48 ms. 1: Overcurrent protection triggered. 0: Overcurrent protection conditions released. FAULT pin pull low and latch, I ² C master need to read and release
1	CABLE_GOOD	R	0	Cable connection good. 1: Output current above 50 mA; 0: Output current less than 50 mA
0	VOUT_GOOD	R	0	LNB output voltage in range. 1: In range; 0: Out of range

8 Application and Implementation

NOTE

Information in the following applications sections is not part of the TI component specification, and TI does not warrant its accuracy or completeness. TI's customers are responsible for determining suitability of components for their purposes. Customers should validate and test their design implementation to confirm system functionality.

8.1 Application Information

TPS65233-1 is a monolithic voltage regulator, specifically to provide the 13-V/18-V power supply and the 22-kHz tone signaling to the LNB down-converter, with I²C interface. I²C GUI software is shared with TPS65233 which is available on ti.com.

8.2 Typical Application

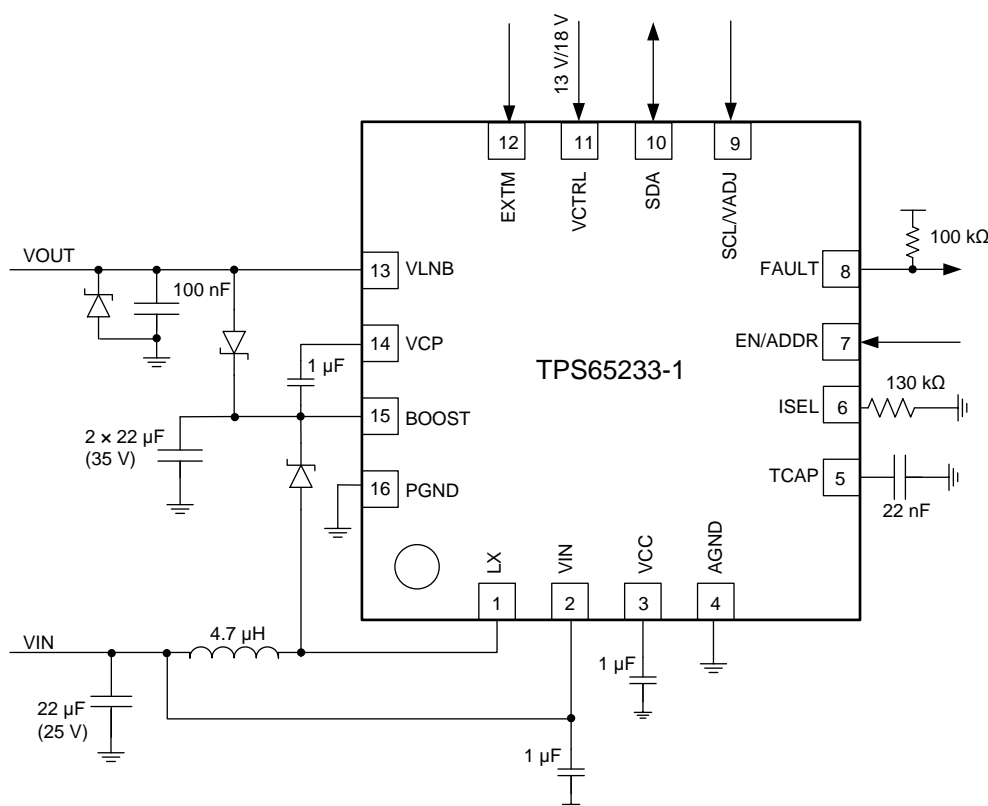

Figure 15. Application Schematic

8.2.1 Detailed Design Procedure

8.2.1.1 Capacitor Selection

In TPS65233-1, a 1-MHz non-synchronous boost converter is integrated and the boost converter features the internal compensation network. 4.7 µH and 10 µH boost inductor are recommended. TPS65233-1 works fine with both ceramic capacitor and electrolytic capacitor. The ceramic capacitors rated at least X7R, 1206 size are preferred for the lower LNB output ripple. Table 8 shows the recommended ceramic capacitors list for both 4.7 µH and 10 µH boost inductors. Minimum output capacitor at the output of the boost converter is 2 × 10-µF/25-V ceramic capacitor when 4.7-µH inductor is selected.

Boost converter is stable with both ceramic capacitor and electrolytic capacitor. If lower cost is demanded, a 100-µF electrolytic and a 1-µF/35-V ceramic capacitor work well, this solution provides lower system cost.

Table 8. Boost Inductor and Capacitor Selections

BOOST INDUCTOR	BOOST OUTPUT CAPACITOR (CERAMIC)
10 μ H	2 \times 22 μ F, 25 V, 1206
	2 \times 10 μ F, 35 V, 1206
	1 \times 22 μ F, 35 V, 1206
	2 \times 22 μ F, 35 V, 1206
4.7 μ H	2 \times 10 μ F, 25 V, 1206
	2 \times 22 μ F, 25 V, 1206
	1 \times 22 μ F, 35 V, 1206
	2 \times 10 μ F, 35 V, 1206
	2 \times 22 μ F, 35 V, 1206

8.2.2 Application Curves

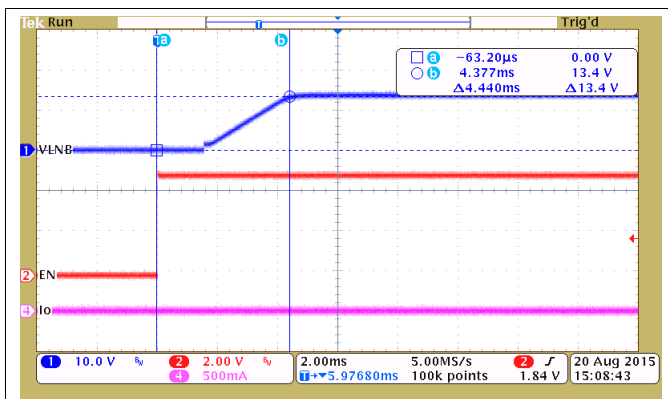

Figure 16. Soft Start, VLNB = 13.4 V, Delay from EN High to LNB Output High

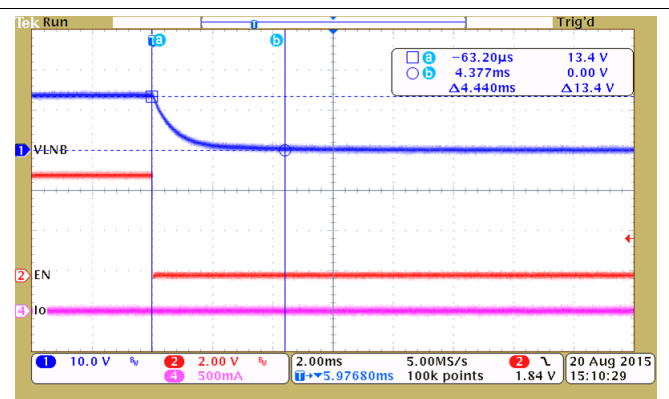

Figure 17. Power Off, VLNB = 13.4 V, Delay from EN Low to LNB Output Low

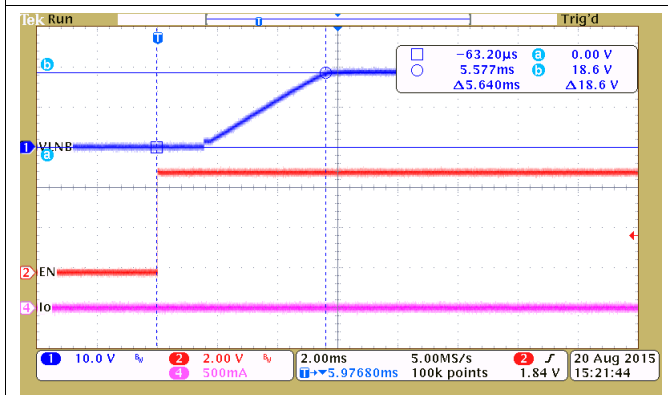

Figure 18. Soft Start, VLNB = 18.6 V, Delay from EN High to LNB Output High

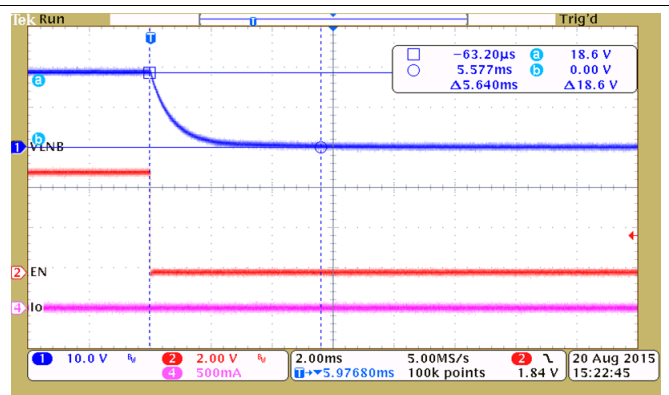

Figure 19. Power Off, VLNB = 18.6 V, Delay from EN Low to LNB Output Low

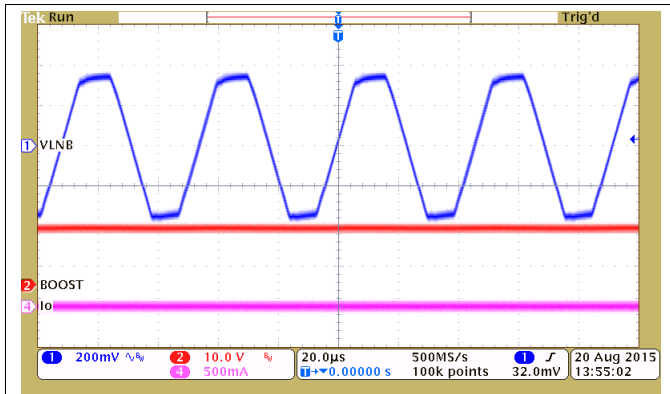

Figure 20. VLNB = 13.4 V, No Load, 22-kHz Tone

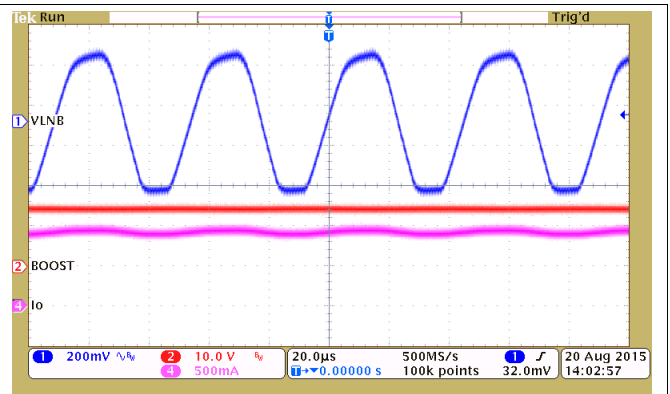

Figure 21. VLNB = 13.4 V, 950 mA, 22-kHz Tone

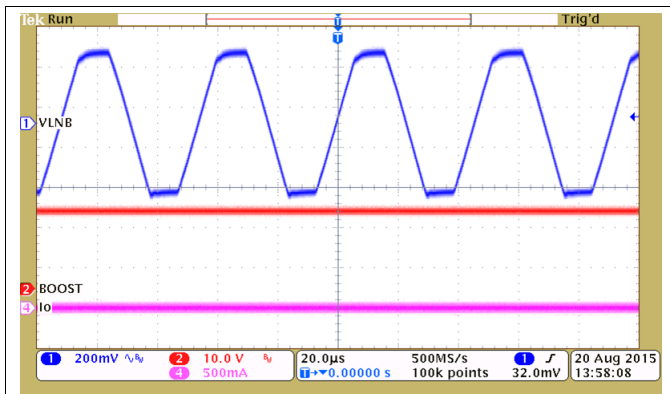

Figure 22. VLNB = 18.6 V, No Load, 22-kHz Tone

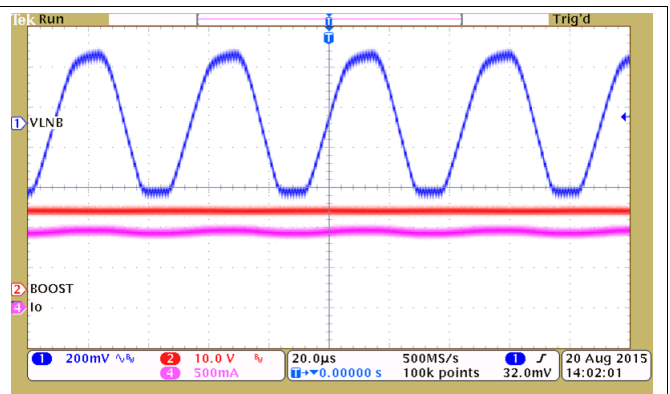

Figure 23. VLNB = 18.6 V, 950 mA, 22-kHz Tone

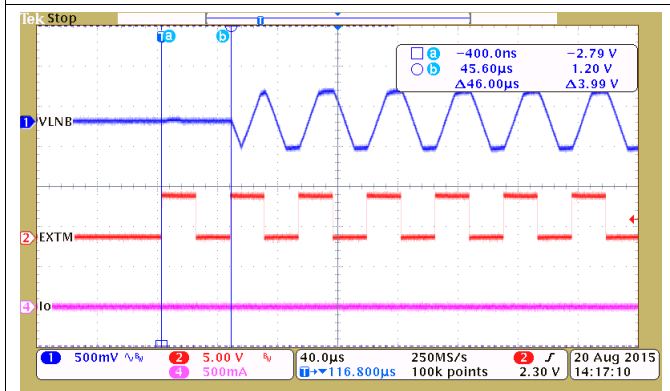

Figure 24. No Load, 22-kHz Tone Delay from EXT Turns High to Output Tone, On

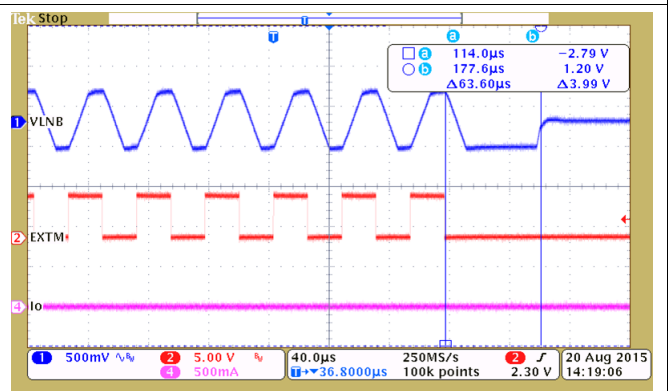

Figure 25. No Load, 22-kHz Tone Delay from EXT Turns Low to Output Tone, Off

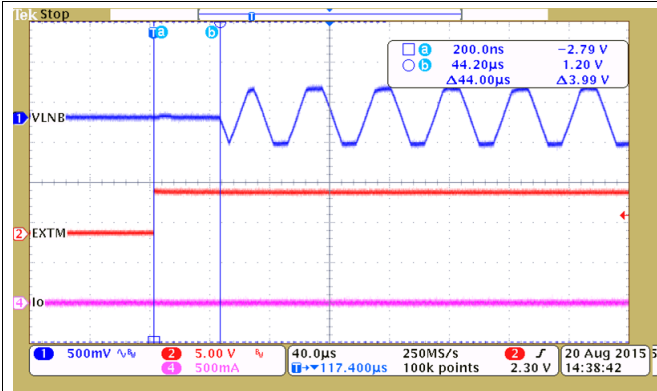

Figure 26. No Load, 22-kHz Tone Delay from EXT Turns High to Output Tone, On

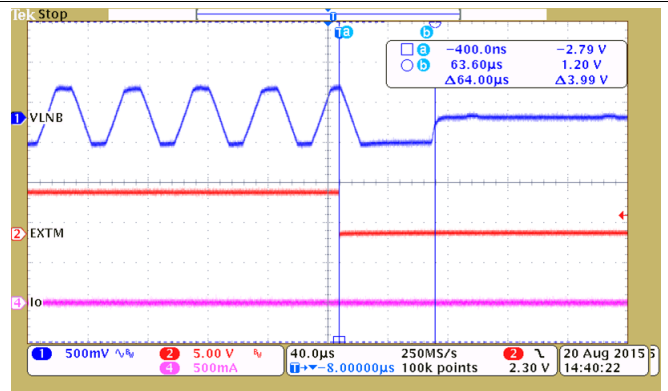

Figure 27. No Load, 22-kHz Tone Delay from EXT Turns Low to Output Tone, Off

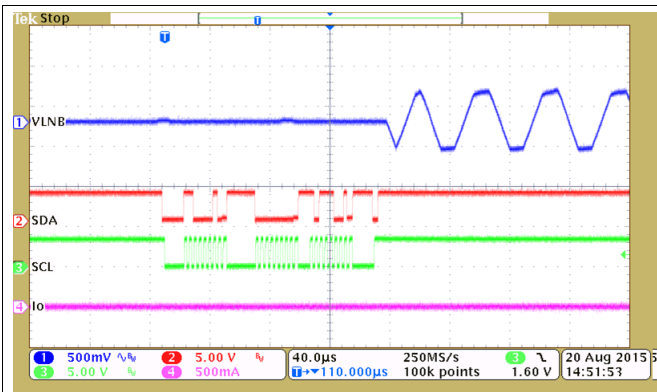

Figure 28. No Load, 22-kHz Tone Delay from I²C SDA to Output Tone, On

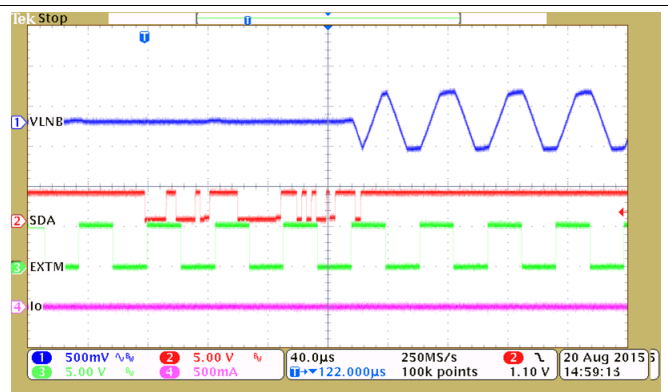

Figure 29. No Load, 22-kHz Tone Delay from I²C Gated, EXT Provides 22 kHz to Output Tone, On

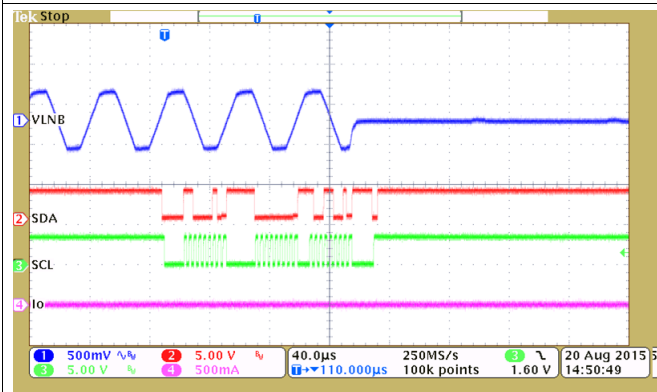

Figure 30. No Load, 22-kHz Tone Delay from I²C SDA to Output Tone, Off

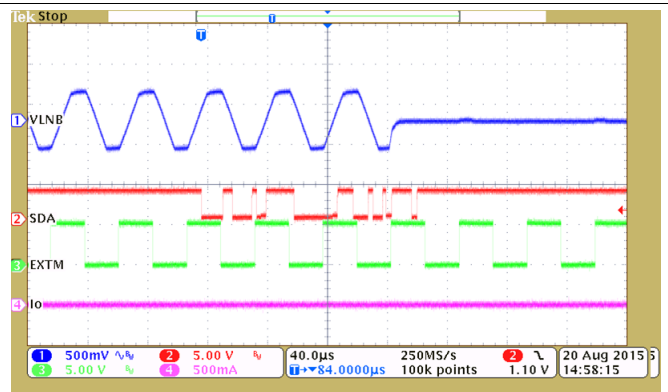

Figure 31. No Load, 22-kHz Tone Delay from I²C Gated, EXT Provides 22 kHz to Output Tone, Off

9 Power Supply Recommendations

The devices are designed to operate from an input supply ranging from 4.5 V to 20 V. The input supply should be well regulated. If the input supply is located more than a few inches from the converter an additional bulk capacitance typically 100 μF may be required in addition to the ceramic bypass capacitors.

10 Layout

10.1 Layout Guidelines

The TPS65233-1 is designed to layout in a 2-layer PCB. [Figure 32](#) shows the recommended layout practice. It is critical to make sure the GND of the input capacitor, output capacitor, and boost converter are connected at one point on the same layer as shown below. PGND and AGND are in different regions and are connected to the thermal pad. Other components are connected to AGND.

10.2 Layout Example

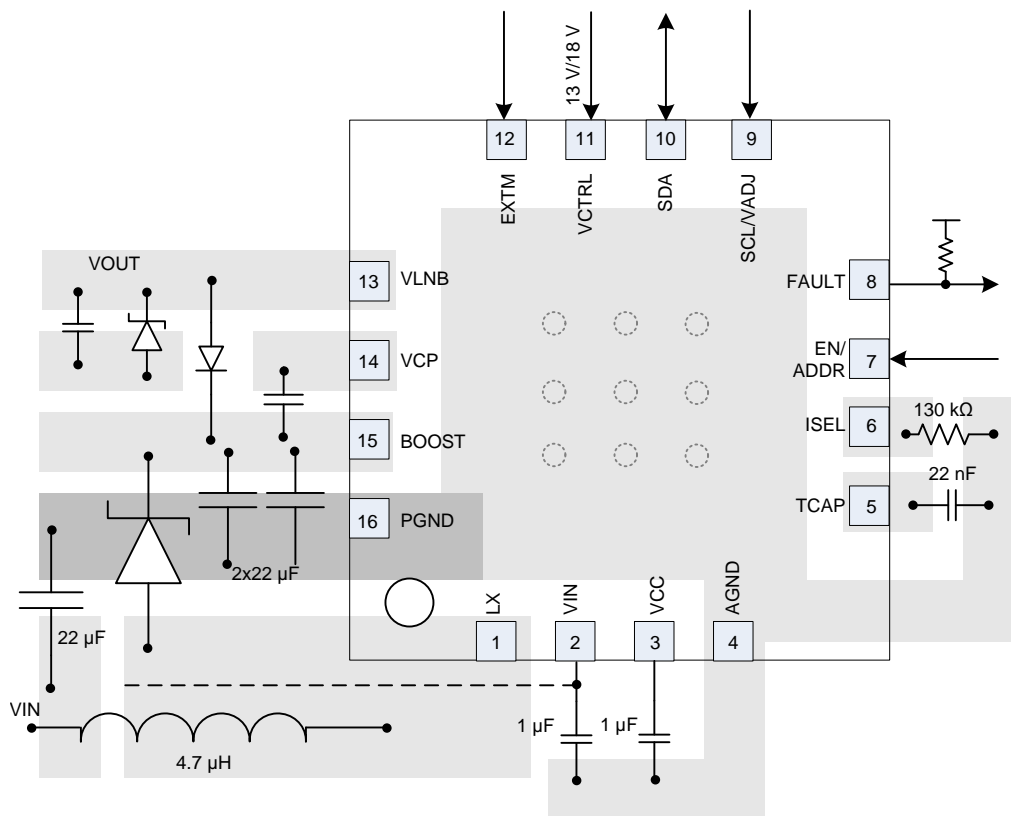

Figure 32. 2-Layer PCB Layout

11 器件和文档支持

11.1 社区资源

下列链接提供到 TI 社区资源的连接。链接的内容由各个分销商“按照原样”提供。这些内容并不构成 TI 技术规范和标准且不一定反映 TI 的观点；请见 TI 的[使用条款](#)。

TI E2E™ 在线社区 **TI 工程师对工程师 (E2E) 社区**。此社区的创建目的是为了促进工程师之间协作。在 e2e.ti.com 中，您可以咨询问题、共享知识、探索思路，在同领域工程师的帮助下解决问题。

设计支持 **TI 参考设计支持** 可帮助您快速查找有帮助的 E2E 论坛、设计支持工具以及技术支持的联系信息。

11.2 商标

E2E is a trademark of Texas Instruments.
All other trademarks are the property of their respective owners.

11.3 静电放电警告



ESD 可能会损坏该集成电路。德州仪器 (TI) 建议通过适当的预防措施处理所有集成电路。如果不遵守正确的处理措施和安装程序，可能会损坏集成电路。

ESD 的损坏小至导致微小的性能降级，大至整个器件故障。精密的集成电路可能更容易受到损坏，这是因为非常细微的参数更改都可能会导致器件与其发布的规格不相符。

11.4 术语表

SLYZ022 — TI 术语表。

这份术语表列出并解释术语、缩写和定义。

12 机械、封装和可订购信息

以下页中包括机械、封装和可订购信息。这些信息是针对指定器件可提供的最新数据。这些数据会在无通知且不对本文档进行修订的情况下发生改变。欲获得该数据表的浏览器版本，请查阅左侧的导航栏

PACKAGING INFORMATION

Orderable Device	Status (1)	Package Type	Package Drawing	Pins	Package Qty	Eco Plan (2)	Lead finish/ Ball material (6)	MSL Peak Temp (3)	Op Temp (°C)	Device Marking (4/5)	Samples
TPS65233-1RTER	ACTIVE	WQFN	RTE	16	3000	RoHS & Green	NIPDAU	Level-2-260C-1 YEAR	-40 to 85	652331	Samples
TPS65233-1RTET	ACTIVE	WQFN	RTE	16	250	RoHS & Green	NIPDAU	Level-2-260C-1 YEAR	-40 to 85	652331	Samples

(1) The marketing status values are defined as follows:

ACTIVE: Product device recommended for new designs.

LIFEBUY: TI has announced that the device will be discontinued, and a lifetime-buy period is in effect.

NRND: Not recommended for new designs. Device is in production to support existing customers, but TI does not recommend using this part in a new design.

PREVIEW: Device has been announced but is not in production. Samples may or may not be available.

OBSOLETE: TI has discontinued the production of the device.

(2) **RoHS:** TI defines "RoHS" to mean semiconductor products that are compliant with the current EU RoHS requirements for all 10 RoHS substances, including the requirement that RoHS substance do not exceed 0.1% by weight in homogeneous materials. Where designed to be soldered at high temperatures, "RoHS" products are suitable for use in specified lead-free processes. TI may reference these types of products as "Pb-Free".

RoHS Exempt: TI defines "RoHS Exempt" to mean products that contain lead but are compliant with EU RoHS pursuant to a specific EU RoHS exemption.

Green: TI defines "Green" to mean the content of Chlorine (Cl) and Bromine (Br) based flame retardants meet JS709B low halogen requirements of <=1000ppm threshold. Antimony trioxide based flame retardants must also meet the <=1000ppm threshold requirement.

(3) MSL, Peak Temp. - The Moisture Sensitivity Level rating according to the JEDEC industry standard classifications, and peak solder temperature.

(4) There may be additional marking, which relates to the logo, the lot trace code information, or the environmental category on the device.

(5) Multiple Device Markings will be inside parentheses. Only one Device Marking contained in parentheses and separated by a "~" will appear on a device. If a line is indented then it is a continuation of the previous line and the two combined represent the entire Device Marking for that device.

(6) Lead finish/Ball material - Orderable Devices may have multiple material finish options. Finish options are separated by a vertical ruled line. Lead finish/Ball material values may wrap to two lines if the finish value exceeds the maximum column width.

Important Information and Disclaimer:The information provided on this page represents TI's knowledge and belief as of the date that it is provided. TI bases its knowledge and belief on information provided by third parties, and makes no representation or warranty as to the accuracy of such information. Efforts are underway to better integrate information from third parties. TI has taken and continues to take reasonable steps to provide representative and accurate information but may not have conducted destructive testing or chemical analysis on incoming materials and chemicals. TI and TI suppliers consider certain information to be proprietary, and thus CAS numbers and other limited information may not be available for release.

In no event shall TI's liability arising out of such information exceed the total purchase price of the TI part(s) at issue in this document sold by TI to Customer on an annual basis.

GENERIC PACKAGE VIEW

RTE 16

WQFN - 0.8 mm max height

3 x 3, 0.5 mm pitch

PLASTIC QUAD FLATPACK - NO LEAD

This image is a representation of the package family, actual package may vary.
Refer to the product data sheet for package details.



4225944/A



SIDE WALL METAL THICKNESS DIM A	
OPTION 1	OPTION 2
0.1	0.2

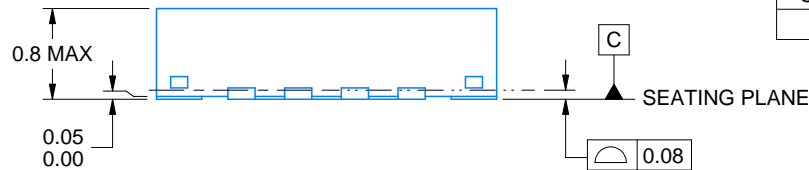

4219117/B 04/2022

NOTES:

1. All linear dimensions are in millimeters. Any dimensions in parenthesis are for reference only. Dimensioning and tolerancing per ASME Y14.5M.
2. This drawing is subject to change without notice.
3. The package thermal pad must be soldered to the printed circuit board for thermal and mechanical performance.

EXAMPLE BOARD LAYOUT

RTE0016C

WQFN - 0.8 mm max height

PLASTIC QUAD FLATPACK - NO LEAD



LAND PATTERN EXAMPLE
EXPOSED METAL SHOWN
SCALE:20X



SOLDER MASK DETAILS

4219117/B 04/2022

NOTES: (continued)

- This package is designed to be soldered to a thermal pad on the board. For more information, see Texas Instruments literature number SLUA271 (www.ti.com/lit/sl原因271).
- Vias are optional depending on application, refer to device data sheet. If any vias are implemented, refer to their locations shown on this view. It is recommended that vias under paste be filled, plugged or tented.

EXAMPLE STENCIL DESIGN

RTE0016C

WQFN - 0.8 mm max height

PLASTIC QUAD FLATPACK - NO LEAD



SOLDER PASTE EXAMPLE
BASED ON 0.125 mm THICK STENCIL

EXPOSED PAD 17:
85% PRINTED SOLDER COVERAGE BY AREA UNDER PACKAGE
SCALE:25X

4219117/B 04/2022

NOTES: (continued)

6. Laser cutting apertures with trapezoidal walls and rounded corners may offer better paste release. IPC-7525 may have alternate design recommendations.

重要声明和免责声明

TI“按原样”提供技术和可靠性数据（包括数据表）、设计资源（包括参考设计）、应用或其他设计建议、网络工具、安全信息和其他资源，不保证没有瑕疵且不做任何明示或暗示的担保，包括但不限于对适销性、某特定用途方面的适用性或不侵犯任何第三方知识产权的暗示担保。

这些资源可供使用 TI 产品进行设计的熟练开发人员使用。您将自行承担以下全部责任：(1) 针对您的应用选择合适的 TI 产品，(2) 设计、验证并测试您的应用，(3) 确保您的应用满足相应标准以及任何其他功能安全、信息安全、监管或其他要求。

这些资源如有变更，恕不另行通知。TI 授权您仅可将这些资源用于研发本资源所述的 TI 产品的应用。严禁对这些资源进行其他复制或展示。您无权使用任何其他 TI 知识产权或任何第三方知识产权。您应全额赔偿因在这些资源的使用中对 TI 及其代表造成的任何索赔、损害、成本、损失和债务，TI 对此概不负责。

TI 提供的产品受 [TI 的销售条款](#) 或 [ti.com](#) 上其他适用条款/TI 产品随附的其他适用条款的约束。TI 提供这些资源并不会扩展或以其他方式更改 TI 针对 TI 产品发布的适用的担保或担保免责声明。

TI 反对并拒绝您可能提出的任何其他或不同的条款。

邮寄地址：Texas Instruments, Post Office Box 655303, Dallas, Texas 75265

Copyright © 2022，德州仪器 (TI) 公司