

## VCA822 Wideband, > 40-dB Gain Adjust Range, Linear in V/V Variable Gain Amplifier

### 1 Features

- 150-MHz Small-Signal Bandwidth ( $G = +10$  V/V)
- 137 MHz, 5 V<sub>PP</sub> Bandwidth ( $G = +10$  V/V)
- 0.1-dB Gain Flatness to 28 MHz
- 1700 V/ $\mu$ s Slew Rate
- > 40-dB Gain Adjust Range
- High Gain Accuracy: 20 dB  $\pm$ 0.3 dB
- High Output Current:  $\pm$ 160 mA

### 2 Applications

- Differential Line Receivers
- Differential Equalizers
- Pulse Amplitude Compensation
- Variable Attenuators
- Voltage-Tunable Active Filters
- Drop-In Upgrade to LMH6503

### 3 Description

The VCA822 device is a DC-coupled, wideband, linear in V/V, continuously variable, voltage-controlled gain amplifier. It provides a differential input to single-ended conversion with a high-impedance gain control input used to vary the gain down 40dB from the nominal maximum gain set by the gain resistor ( $R_G$ ) and feedback resistor ( $R_F$ ).

The internal architecture of the VCA822 device consists of two input buffers and an output current feedback amplifier stage integrated with a multiplier core to provide a complete variable gain amplifier (VGA) system that does not require external buffering. The maximum gain is set externally with two resistors, providing flexibility in designs. The maximum gain is intended to be set between +2 V/V and +100 V/V. Operating from  $\pm$ 5-V supplies, the gain control voltage for the VCA822 device adjusts the gain linearly in V/V as the control voltage varies from +1 V to 1 V. For example, set for a maximum gain of +10 V/V, the VCA822 device provides 10 V/V, at 1-V input, to 0.1 V/V at  $-1$  V input of gain control range. The VCA822 device offers excellent gain linearity. For a 20-dB maximum gain and a gain-control input voltage varying between 0 V and 1 V, the gain does not deviate by more than  $\pm$ 0.3 dB (maximum at +25°C).

#### Device Information<sup>(1)</sup>

PART NUMBER	PACKAGE	BODY SIZE (NOM)
VCA822	SOIC (14)	8.65 mm x 3.91 mm
	VSSOP (10)	3.00 mm x 3.00 mm

(1) For more information, see *Mechanical Packaging and Orderable Information*.

#### Differential Equalizer

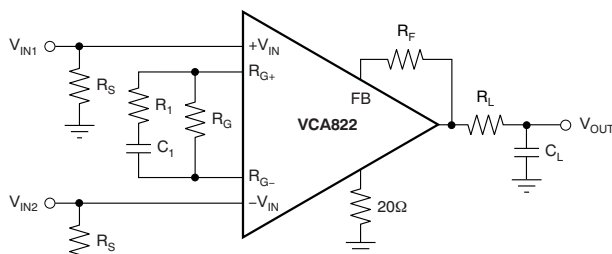

#### Differential Equalization of an RC Load

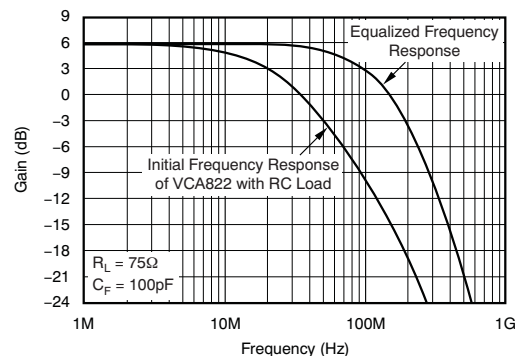

## Table of Contents

<b>1 Features</b> ..... 1 <b>2 Applications</b> ..... 1 <b>3 Description</b> ..... 1 <b>4 Revision History</b> ..... 2 <b>5 Device Comparison Table</b> ..... 4 <b>6 Pin Configuration and Functions</b> ..... 4 <b>7 Specifications</b> ..... 5 7.1 Absolute Maximum Ratings ..... 5 7.2 ESD Ratings ..... 5 7.3 Recommended Operating Conditions ..... 5 7.4 Thermal Information ..... 5 7.5 Electrical Characteristics: $V_S = \pm 5\text{ V}$ ..... 6 7.6 Typical Characteristics: $V_S = \pm 5\text{ V}$ , DC Parameters ..... 9 7.7 Typical Characteristics: $V_S = \pm 5\text{ V}$ , DC and Power-Supply Parameters ..... 10 7.8 Typical Characteristics: $V_S = \pm 5\text{ V}$ , $A_{VMAX} = +2\text{ V/V}$ ..... 11 7.9 Typical Characteristics: $V_S = \pm 5\text{ V}$ , $A_{VMAX} = +10\text{ V/V}$ ..... 14 7.10 Typical Characteristics: $V_S = \pm 5\text{ V}$ , $A_{VMAX} = +100\text{ V/V}$ ..... 18 <b>8 Parameter Measurement Information</b> ..... 21	<b>9 Detailed Description</b> ..... 22 9.1 Overview ..... 22 9.2 Feature Description ..... 22 9.3 Device Functional Modes ..... 22 <b>10 Application and Implementation</b> ..... 25 10.1 Application Information ..... 25 10.2 Typical Applications ..... 27 10.3 System Examples ..... 34 <b>11 Power Supply Recommendations</b> ..... 36 <b>12 Layout</b> ..... 36 12.1 Layout Guidelines ..... 36 12.2 Layout Example ..... 37 12.3 Thermal Considerations ..... 37 <b>13 Device and Documentation Support</b> ..... 38 13.1 Device Support ..... 38 13.2 Community Resources ..... 38 13.3 Trademarks ..... 38 13.4 Electrostatic Discharge Caution ..... 38 13.5 Glossary ..... 38 <b>14 Mechanical, Packaging, and Orderable Information</b> ..... 38
--	---

## 4 Revision History

NOTE: Page numbers for previous revisions may differ from page numbers in the current version.

Changes from Revision C (December 2008) to Revision D	Page
<ul style="list-style-type: none"> <li>• Added <i>Pin Configuration and Functions</i> section, <i>ESD Ratings</i> table, <i>Recommended Operating Conditions</i> table, <i>Feature Description</i> section, <i>Device Functional Modes</i>, <i>Application and Implementation</i> section, <i>Power Supply Recommendations</i> section, <i>Layout</i> section, <i>Device and Documentation Support</i> section, and <i>Mechanical, Packaging, and Orderable Information</i> section ..... 1</li> </ul>	1

Changes from Revision B (August 2008) to Revision C	Page
<ul style="list-style-type: none"> <li>• Revised second paragraph in the <i>Wideband Variable Gain Amplifier Operation</i> section describing pin 9 ..... 27</li> </ul>	27

Changes from Revision A (October 2007) to Revision B	Page
<ul style="list-style-type: none"> <li>• Changed storage temperature range rating in <i>Absolute Maximum Ratings</i> table from <math>-40^\circ\text{C}</math> to <math>+125^\circ\text{C}</math> to <math>-65^\circ\text{C}</math> to <math>+125^\circ\text{C}</math> ..... 5</li> </ul>	5

Changes from Original (September 2007) to Revision A	Page
<ul style="list-style-type: none"> <li>• Changed <math>G_{MAX}</math> to <math>A_{VMAX}</math> throughout document ..... 1</li> <li>• Changed <math>G</math> to <math>A_{VMAX}</math> in conditions in the <i>Electrical Characteristics: <math>V_S = \pm 5\text{ V}</math></i> table ..... 6</li> <li>• Changed 5th row of AC Performance section in the <i>Electrical Characteristics: <math>V_S = \pm 5\text{ V}</math></i> table ..... 6</li> <li>• Changed 4th row of Output section in the <i>Electrical Characteristics: <math>V_S = \pm 5\text{ V}</math></i> table ..... 6</li> <li>• Changed <a href="#">Figure 7</a>, the title of <a href="#">Figure 8</a>, the title of <a href="#">Figure 9</a>, the title of <a href="#">Figure 10</a>, and <a href="#">Figure 11</a> in the <math>\pm 5\text{V}</math>, DC and Power-Supply Parameters <i>Typical Characteristics</i> ..... 10</li> <li>• Changed <a href="#">Figure 78</a>, <a href="#">Figure 18</a>, <a href="#">Figure 20</a>, <a href="#">Figure 22</a>, and <a href="#">Figure 27</a> in the <math>\pm 5\text{V}</math>, <math>A_{VMAX} = +2\text{V/V}</math> <i>Typical Characteristics</i> ..... 11</li> </ul>	11

- Changed [Figure 32](#), [Figure 48](#), and [Figure 52](#) in the  $\pm 5V$ ,  $A_{VMAX} = +10V/V$  *Typical Characteristics* ..... 14
- Changed [Figure 53](#) and [Figure 72](#) in the  $\pm 5V$ ,  $A_{VMAX} = +100V/V$  *Typical Characteristics* ..... 18
- Changed [Table 1](#) in the *Demonstration Boards* section..... 25
- Changed 2200V/ $\mu s$  to 1700V/ $\mu s$  in first paragraph of the *Wideband Variable Gain Amplifier Operation Application* section. .... 27
- Changed rail quantity for VCA822ID in the Ordering Information table ..... 38

---

## 5 Device Comparison Table

**VCA822 Related Products**

SINGLES	DUALS	GAIN ADJUST RANGE (dB)	INPUT NOISE (nV/√Hz)	SIGNAL BANDWIDTH (MHz)
VCA810	—	80	2.4	35
—	VCA2612	45	1.25	80
—	VCA2613	45	1	80
—	VCA2615	52	0.8	50
—	VCA2617	48	4.1	50
VCA820	—	40	8.2	150
VCA821	—	40	7.0	420
VCA822	—	40	8.2	150
VCA824	—	40	7.0	420

## 6 Pin Configuration and Functions

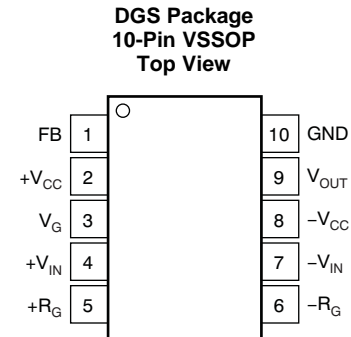
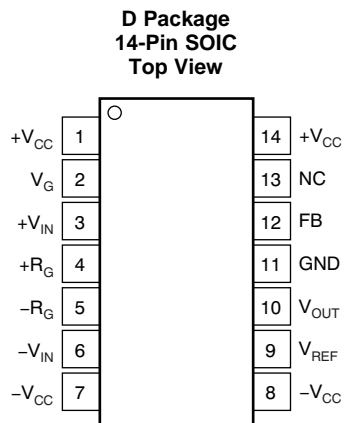

NC = No Connection

### Pin Functions

NAME	PIN		I/O	DESCRIPTION
	SOIC	VSSOP		
FB	12	1	I	Feedback Resistor Input
GND	11	—	—	Ground
NC	13	—	—	No Connect
+RG	4	5	I	Gain Set Resistor
-RG	5	6	I	Gain Set Resistor
-VCC	7, 8	8	P	Negative Supply
+VCC	1, 14	2	P	Positive Supply
VG	2	3	I	Gain Control
-VIN	6	7	I	Inverting Input
+VIN	3	4	I	Noninverting Input
VOUT	10	9	O	Output
VREF	9	—	I	Output Voltage Reference

## 7 Specifications

### 7.1 Absolute Maximum Ratings

Over operating free-air temperature range, unless otherwise noted.<sup>(1)</sup>

	MIN	MAX	UNIT
Power supply		±6.5	V
Internal power dissipation	See <a href="#">Thermal Information</a>		
Input voltage		±V <sub>S</sub>	V
Lead temperature (soldering, 10 s)		260	°C
Junction temperature (T <sub>J</sub> )		150	°C
Junction temperature (T <sub>J</sub> ), maximum continuous operation		140	°C
Storage temperature	–65	125	°C

- (1) Stresses beyond those listed under *Absolute Maximum Ratings* may cause permanent damage to the device. These are stress ratings only, which do not imply functional operation of the device at these or any other conditions beyond those indicated under *Recommended Operating Conditions*. Exposure to absolute-maximum-rated conditions for extended periods may affect device reliability.

### 7.2 ESD Ratings

		VALUE	UNIT
V <sub>(ESD)</sub> Electrostatic discharge	Human-body model (HBM), per ANSI/ESDA/JEDEC JS-001 <sup>(1)</sup>	±2000	V
	Charged-device model (CDM), per JEDEC specification JESD22-C101 <sup>(2)</sup>	±500	
	Machine model (MM)	±200	

- (1) JEDEC document JEP155 states that 500-V HBM allows safe manufacturing with a standard ESD control process.

- (2) JEDEC document JEP157 states that 250-V CDM allows safe manufacturing with a standard ESD control process.

### 7.3 Recommended Operating Conditions

over operating free-air temperature range (unless otherwise noted)

	MIN	NOM	MAX	UNIT
Operating voltage	7	10	12	V
Operating temperature	–40	25	85	°C

### 7.4 Thermal Information

THERMAL METRIC <sup>(1)</sup>	VCA822		UNIT
	D [SOIC]	DGS [VSSOP]	
	14 PINS	10 PINS	
R <sub>θJA</sub> Junction-to-ambient thermal resistance	90.3	173.1	°C/W
R <sub>θJC(top)</sub> Junction-to-case (top) thermal resistance	49.8	46.6	°C/W
R <sub>θJB</sub> Junction-to-board thermal resistance	44.9	94.3	°C/W
ψ <sub>JT</sub> Junction-to-top characterization parameter	13.8	2.2	°C/W
ψ <sub>JB</sub> Junction-to-board characterization parameter	44.6	92.7	°C/W
R <sub>θJC(bot)</sub> Junction-to-case (bottom) thermal resistance	n/a	n/a	°C/W

- (1) For more information about traditional and new thermal metrics, see the *Semiconductor and IC Package Thermal Metrics* application report, [SPRA953](#).

## 7.5 Electrical Characteristics: $V_S = \pm 5\text{ V}$

 At  $A_{V_{MAX}} = +10\text{ V/V}$ ,  $R_F = 1\text{ k}\Omega$ ,  $R_G = 200\ \Omega$ , and  $R_L = 100\ \Omega$ ,  $25^\circ\text{C}$ , unless otherwise noted.

PARAMETER	TEST CONDITIONS	MIN	TYP	MAX	UNIT	TEST LEVEL <sup>(1)</sup>		
<b>AC PERFORMANCE</b>								
Small-signal bandwidth (SOIC-14 Package)	$A_{V_{MAX}} = +2\text{V/V}$ , $V_O = 1\text{ V}_{PP}$ , $V_G = 1\text{ V}$		168		MHz	C		
	$A_{V_{MAX}} = +10\text{V/V}$ , $V_O = 1\text{ V}_{PP}$ , $V_G = 1\text{ V}$		150		MHz	C		
	$A_{V_{MAX}} = +100\text{V/V}$ , $V_O = 1\text{ V}_{PP}$ , $V_G = 1\text{ V}$		118		MHz	C		
Large-signal bandwidth	$A_{V_{MAX}} = +10\text{V/V}$ , $V_O = 5\text{V}_{PP}$ , $V_G = 1\text{ V}$		137		MHz	C		
Gain control bandwidth	$V_G = 0\text{V}_{DC} + 10\text{ mV}_{PP}$	$25^\circ\text{C}^{(2)}$	170	200	MHz	B		
		$0^\circ\text{C to } 70^\circ\text{C}^{(3)}$	170					
		$-40^\circ\text{C to } +85^\circ\text{C}^{(3)}$	165					
Bandwidth for 0.1dB flatness	$A_{V_{MAX}} = +10\text{V/V}$ , $V_O = 1\text{V}_{PP}$ , $V_G = 1\text{ V}$		28		MHz	C		
Slew rate	$A_{V_{MAX}} = +10\text{V/V}$ , $V_O = 5\text{-V Step}$ , $V_G = 1\text{ V}$	$25^\circ\text{C}^{(2)}$	1500	1700	V/ $\mu\text{s}$	B		
		$0^\circ\text{C to } 70^\circ\text{C}^{(3)}$	1500					
		$-40^\circ\text{C to } +85^\circ\text{C}^{(3)}$	1450					
Rise-and-fall time	$A_{V_{MAX}} = +10\text{V/V}$ , $V_O = 5\text{-V Step}$ , $V_G = 1\text{ V}$	$25^\circ\text{C}^{(2)}$		2.5	3.1	ns	B	
		$0^\circ\text{C to } 70^\circ\text{C}^{(3)}$						3.2
		$-40^\circ\text{C to } +85^\circ\text{C}^{(3)}$						3.2
Settling time to 0.01%	$A_{V_{MAX}} = +10\text{V/V}$ , $V_O = 5\text{V Step}$ , $V_G = 1\text{ V}$		11		ns	C		
Harmonic distortion, 2nd-harmonic	$V_O = 2\text{V}_{PP}$ , $f = 20\text{MHz}$ , $V_G = 1\text{ V}$	$25^\circ\text{C}^{(2)}$	-60	-62	dBc	B		
		$0^\circ\text{C to } 70^\circ\text{C}^{(3)}$	-60					
		$-40^\circ\text{C to } +85^\circ\text{C}^{(3)}$	-60					
Harmonic distortion, 3rd-harmonic	$V_O = 2\text{V}_{PP}$ , $f = 20\text{MHz}$ , $V_G = 1\text{ V}$	$25^\circ\text{C}^{(2)}$	-66	-68	dBc	B		
		$0^\circ\text{C to } 70^\circ\text{C}^{(3)}$	-66					
		$-40^\circ\text{C to } +85^\circ\text{C}^{(3)}$	-66					
Input voltage noise	$f > 100\text{kHz}$ , $V_G = 1\text{ V}$		8.2		nV/ $\sqrt{\text{Hz}}$	C		
Input current noise	$f > 100\text{kHz}$ , $V_G = 1\text{ V}$		2.6		pA/ $\sqrt{\text{Hz}}$	C		
<b>GAIN CONTROL</b>								
Absolute gain error	$A_{V_{MAX}} = +10\text{V/V}$ , $V_G = 1\text{ V}$	$25^\circ\text{C}^{(2)}$	$\pm 0.1$	$\pm 0.4$	dB	A		
		$0^\circ\text{C to } 70^\circ\text{C}^{(3)}$		$\pm 0.5$				
		$-40^\circ\text{C to } +85^\circ\text{C}^{(3)}$		$\pm 0.6$				
Gain deviation	$A_{V_{MAX}} = +10\text{V/V}$ , $0 < V_G < 1\text{ V}$	$25^\circ\text{C}^{(2)}$	$\pm 0.05$	$\pm 0.3$	dB	A		
		$0^\circ\text{C to } 70^\circ\text{C}^{(3)}$		$\pm 0.34$				
		$-40^\circ\text{C to } +85^\circ\text{C}^{(3)}$		$\pm 0.37$				
Gain deviation	$A_{V_{MAX}} = +10\text{V/V}$ , $-0.8 < V_G < 1\text{ V}$	$25^\circ\text{C}^{(2)}$	$\pm 1.06$	$\pm 1.9$	dB	A		
		$0^\circ\text{C to } 70^\circ\text{C}^{(3)}$		$\pm 2.1$				
		$-40^\circ\text{C to } +85^\circ\text{C}^{(3)}$		$\pm 2.2$				
Gain at $V_G = -0.9\text{V}$	Relative to maximum gain	$25^\circ\text{C}^{(2)}$	-26	-24	dB	A		
		$0^\circ\text{C to } 70^\circ\text{C}^{(3)}$		-24				
		$-40^\circ\text{C to } +85^\circ\text{C}^{(3)}$		-23				
Gain control bias current	$V_G = 0\text{ V}$	$25^\circ\text{C}^{(2)}$	22	30	$\mu\text{A}$	A		
		$0^\circ\text{C to } 70^\circ\text{C}^{(3)}$		35				
		$-40^\circ\text{C to } +85^\circ\text{C}^{(3)}$		37				
Average gain control bias current drift	$V_G = 0\text{ V}$	$0^\circ\text{C to } 70^\circ\text{C}^{(3)}$		$\pm 100$	nA/ $^\circ\text{C}$	B		
		$-40^\circ\text{C to } +85^\circ\text{C}^{(3)}$		$\pm 100$				
Gain control input impedance			$70\ \Omega \parallel 1$		k $\Omega \parallel$ pF	C		
<b>DC PERFORMANCE</b>								
Input offset voltage	$A_{V_{MAX}} = +10\text{V/V}$ , $V_{CM} = 0\text{ V}$ , $V_G = 0\text{ V}$	$25^\circ\text{C}^{(2)}$	$\pm 4$	$\pm 17$	mV	A		
		$0^\circ\text{C to } 70^\circ\text{C}^{(3)}$		$\pm 17.8$				
		$-40^\circ\text{C to } +85^\circ\text{C}^{(3)}$		$\pm 19$				
Average input offset voltage drift	$A_{V_{MAX}} = +10\text{V/V}$ , $V_{CM} = 0\text{ V}$ , $V_G = 0\text{ V}$	$0^\circ\text{C to } 70^\circ\text{C}^{(3)}$		$\pm 30$	$\mu\text{V}/^\circ\text{C}$	B		
		$-40^\circ\text{C to } +85^\circ\text{C}^{(3)}$		$\pm 30$				

- (1) Test levels: **(A)** 100% tested at  $25^\circ\text{C}$ . Over temperature limits set by characterization and simulation. **(B)** Limits set by characterization and simulation. **(C)** Typical value only for information.
- (2) Junction temperature = ambient at  $+25^\circ\text{C}$  tested specifications.
- (3) Junction temperature = ambient at low temperature limit; junction temperature = ambient  $+23^\circ\text{C}$  at high temperature limit for over temperature specifications.

**Electrical Characteristics:  $V_S = \pm 5\text{ V}$  (continued)**

At  $A_{VMAX} = +10\text{ V/V}$ ,  $R_F = 1\text{ k}\Omega$ ,  $R_G = 200\ \Omega$ , and  $R_L = 100\ \Omega$ ,  $25^\circ\text{C}$ , unless otherwise noted.

PARAMETER	TEST CONDITIONS	MIN	TYP	MAX	UNIT	TEST LEVEL <sup>(1)</sup>
Input bias current	$A_{VMAX} = +10\text{V/V}$ , $V_{CM} = 0\text{ V}$ , $V_G = 0\text{ V}$	$25^\circ\text{C}^{(2)}$	19	25	$\mu\text{A}$	A
		$0^\circ\text{C to }70^\circ\text{C}^{(3)}$		29		
		$-40^\circ\text{C to }+85^\circ\text{C}^{(3)}$		31		
Average input bias current drift	$A_{VMAX} = +10\text{V/V}$ , $V_{CM} = 0\text{ V}$ , $V_G = 0\text{ V}$	$0^\circ\text{C to }70^\circ\text{C}^{(3)}$		$\pm 90$	$\text{nA}/^\circ\text{C}$	B
		$-40^\circ\text{C to }+85^\circ\text{C}^{(3)}$		$\pm 90$		
Input offset current	$A_{VMAX} = +10\text{V/V}$ , $V_{CM} = 0\text{ V}$ , $V_G = 0\text{ V}$	$25^\circ\text{C}^{(2)}$	$\pm 0.5$	$\pm 2.5$	$\mu\text{A}$	A
		$0^\circ\text{C to }70^\circ\text{C}^{(3)}$		$\pm 3.2$		
		$-40^\circ\text{C to }+85^\circ\text{C}^{(3)}$		$\pm 3.5$		
Average input offset current drift	$A_{VMAX} = +10\text{V/V}$ , $V_{CM} = 0\text{ V}$ , $V_G = 0\text{ V}$	$0^\circ\text{C to }70^\circ\text{C}^{(3)}$		$\pm 16$	$\text{nA}/^\circ\text{C}$	B
		$-40^\circ\text{C to }+85^\circ\text{C}^{(3)}$		$\pm 16$		
$I_{RG\text{ MAX}}$ Maximum current through gain resistance		$25^\circ\text{C}^{(2)}$		$\pm 2.6$	$\text{mA}$	B
		$0^\circ\text{C to }70^\circ\text{C}^{(3)}$		$\pm 2.55$		
		$-40^\circ\text{C to }+85^\circ\text{C}^{(3)}$		$\pm 2.5$		
<b>INPUT</b>						
Most positive input voltage	$R_L = 100\ \Omega$	$25^\circ\text{C}^{(2)}$	+1.6	+1.6	V	A
		$0^\circ\text{C to }70^\circ\text{C}^{(3)}$		+1.6		
		$-40^\circ\text{C to }+85^\circ\text{C}^{(3)}$		+1.6		
Most negative input voltage	$R_L = 100\ \Omega$	$25^\circ\text{C}^{(2)}$	-2.1	-2.1	V	A
		$0^\circ\text{C to }70^\circ\text{C}^{(3)}$		-2.1		
		$-40^\circ\text{C to }+85^\circ\text{C}^{(3)}$		-2.1		
Common-mode rejection ratio	$V_{CM} = \pm 0.5\text{V}$	$25^\circ\text{C}^{(2)}$	65	80	dB	A
		$0^\circ\text{C to }70^\circ\text{C}^{(3)}$		60		
		$-40^\circ\text{C to }+85^\circ\text{C}^{(3)}$		60		
Input impedance, differential			$0.5 \parallel 1$		$\text{M}\Omega \parallel \text{pF}$	C
Input impedance, common-mode			$0.5 \parallel 2$		$\text{M}\Omega \parallel \text{pF}$	C
<b>OUTPUT</b>						
Output voltage swing	$R_L = 1\text{k}\Omega$	$25^\circ\text{C}^{(2)}$	$\pm 3.8$	$\pm 4.0$	V	A
		$0^\circ\text{C to }70^\circ\text{C}^{(3)}$		$\pm 3.75$		
		$-40^\circ\text{C to }+85^\circ\text{C}^{(3)}$		$\pm 3.7$		
	$R_L = 100\ \Omega$	$25^\circ\text{C}^{(2)}$	$\pm 3.7$	$\pm 3.9$	V	A
		$0^\circ\text{C to }70^\circ\text{C}^{(3)}$		$\pm 3.6$		
		$-40^\circ\text{C to }+85^\circ\text{C}^{(3)}$		$\pm 3.5$		
Output current	$V_O = 0\text{V}$ , $R_L = 5\ \Omega$	$25^\circ\text{C}^{(2)}$	$\pm 140$	$\pm 160$	$\text{mA}$	A
		$0^\circ\text{C to }70^\circ\text{C}^{(3)}$		$\pm 130$		
		$-40^\circ\text{C to }+85^\circ\text{C}^{(3)}$		$\pm 130$		
Output impedance	$A_{VMAX} = +10\text{V/V}$ , $f > 100\text{kHz}$ , $V_G = 1\text{V}$		0.01		$\Omega$	C
<b>POWER SUPPLY</b>						
Specified operating voltage			$\pm 5$		V	C
Minimum operating voltage			$\pm 3.5$		V	C
Maximum operating voltage		$25^\circ\text{C}^{(2)}$			V	A
		$0^\circ\text{C to }70^\circ\text{C}^{(3)}$				
		$-40^\circ\text{C to }+85^\circ\text{C}^{(3)}$				
Maximum quiescent current	$V_G = 0\text{V}$	$25^\circ\text{C}^{(2)}$	36	37	$\text{mA}$	A
		$0^\circ\text{C to }70^\circ\text{C}^{(3)}$		37.5		
		$-40^\circ\text{C to }+85^\circ\text{C}^{(3)}$		38		
Minimum quiescent current	$V_G = 0\text{V}$	$25^\circ\text{C}^{(2)}$	36	34.5	$\text{mA}$	A
		$0^\circ\text{C to }70^\circ\text{C}^{(3)}$		34		
		$-40^\circ\text{C to }+85^\circ\text{C}^{(3)}$		33.5		
-PSRR Power-supply rejection ratio	$V_G = +1\text{V}$	$25^\circ\text{C}^{(2)}$	-61	-68	dB	A
		$0^\circ\text{C to }70^\circ\text{C}^{(3)}$		-59		
		$-40^\circ\text{C to }+85^\circ\text{C}^{(3)}$		-58		

**Electrical Characteristics:  $V_S = \pm 5\text{ V}$  (continued)**

 At  $A_{V_{MAX}} = +10\text{ V/V}$ ,  $R_F = 1\text{ k}\Omega$ ,  $R_G = 200\ \Omega$ , and  $R_L = 100\ \Omega$ ,  $25^\circ\text{C}$ , unless otherwise noted.

PARAMETER		TEST CONDITIONS	MIN	TYP	MAX	UNIT	TEST LEVEL <sup>(1)</sup>
<b>THERMAL CHARACTERISTICS</b>							
Specified operating range, D package			-40 to +85			°C	C
$\theta_{JA}$	Junction-to-ambient Thermal resistance	MSOP-10 (DGS)	130			°C/W	C
		SOIC-14 (D)	80			°C/W	C



### 7.6 Typical Characteristics: $V_S = \pm 5\text{ V}$ , DC Parameters

At  $T_A = 25^\circ\text{C}$ ,  $R_L = 100\ \Omega$ ,  $V_G = 1\text{ V}$ , and  $V_{IN}$  = single-ended input on  $+V_{IN}$  with  $-V_{IN}$  at ground, unless otherwise noted.

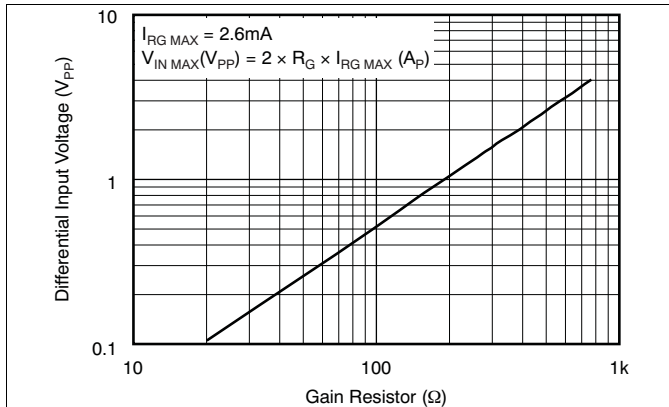

Figure 1. Maximum Differential Input Voltage vs  $R_G$

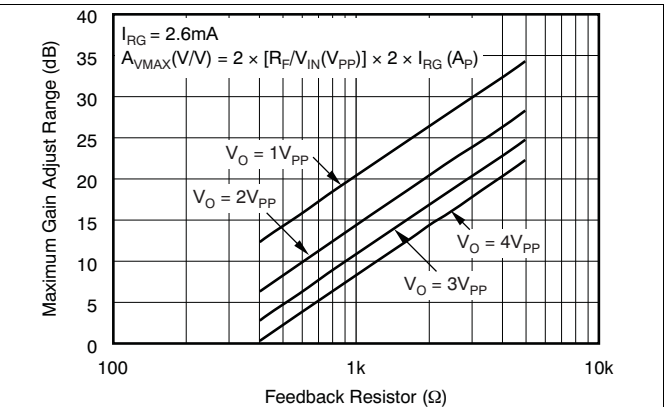

Figure 2. Maximum Gain Adjust Range vs  $R_F$

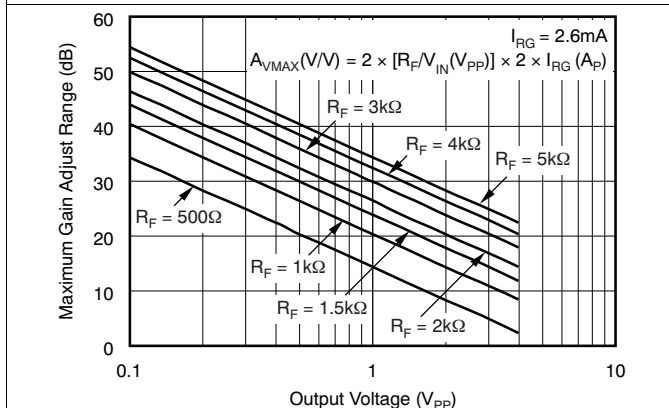

Figure 3. Maximum Gain Adjust Range vs Peak-to-Peak Output Voltage

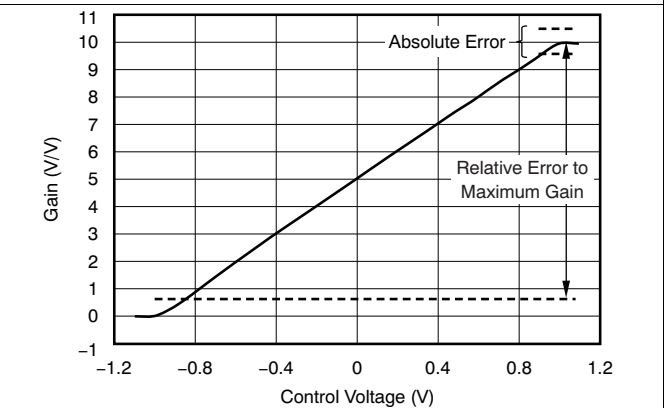

Figure 4. Gain Error Band vs Gain Control Voltage

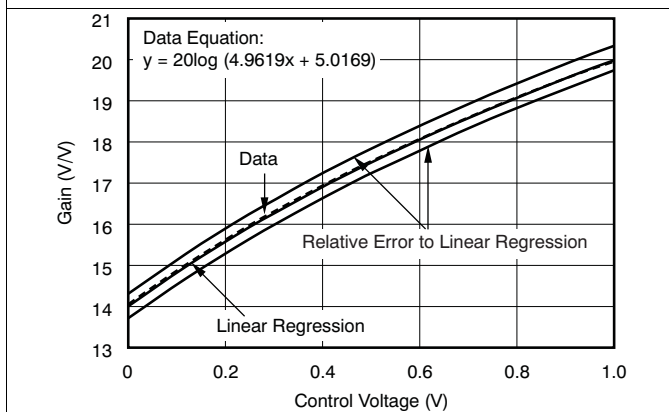

Figure 5. Gain Error Band vs Gain Control Voltage

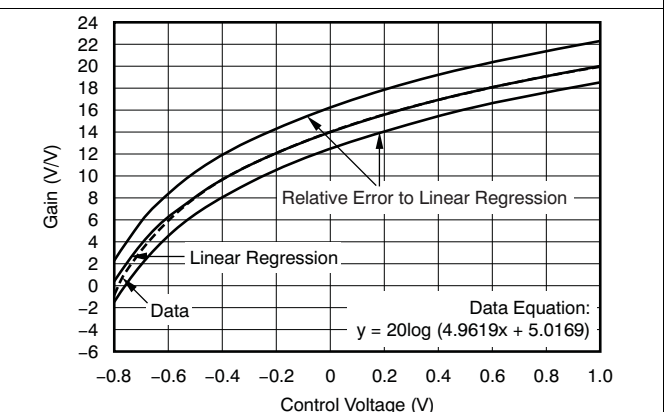

Figure 6. Gain Error Band vs Gain Control Voltage

### 7.7 Typical Characteristics: $V_S = \pm 5\text{ V}$ , DC and Power-Supply Parameters

At  $T_A = +25^\circ\text{C}$ ,  $R_L = 100\ \Omega$ ,  $V_G = +1\text{ V}$ , and  $V_{IN}$  = single-ended input on  $+V_{IN}$  with  $-V_{IN}$  at ground, unless otherwise noted.

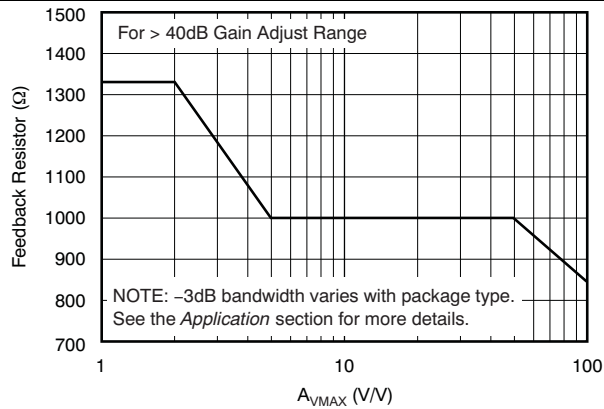

Figure 7. Recommended  $R_F$  vs  $A_{VMAX}$

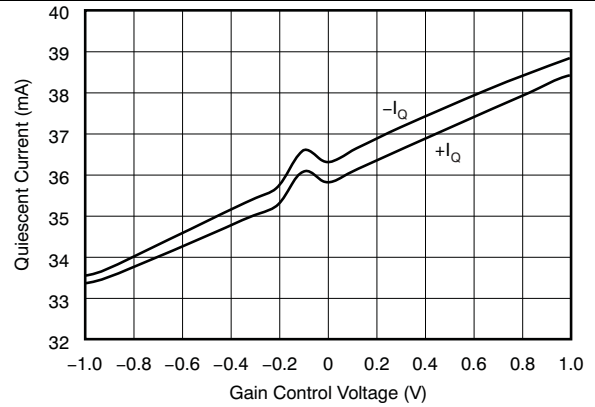

Figure 8. Supply Current vs Control Voltage ( $A_{VMAX} = +2\text{ V/V}$ )

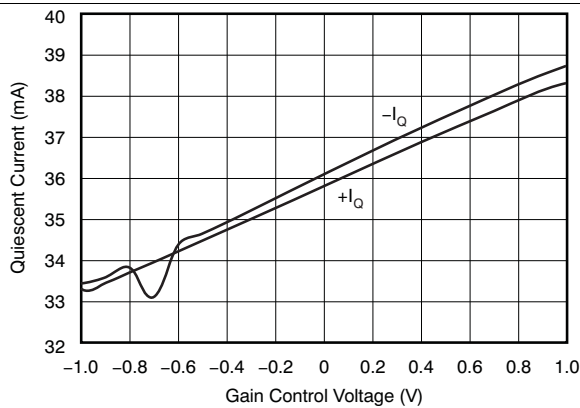

Figure 9. Supply Current vs Control Voltage ( $A_{VMAX} = +10\text{ V/V}$ )

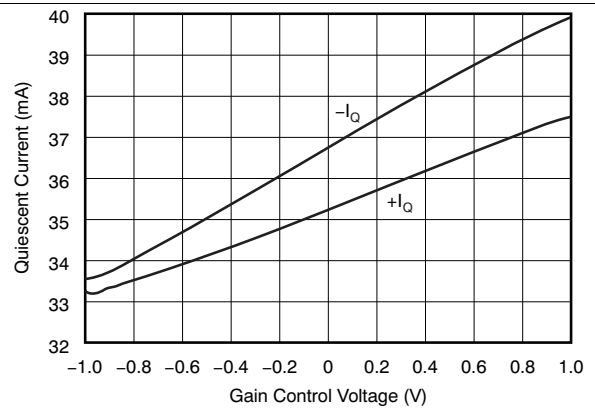

Figure 10. Supply Current vs Control Voltage ( $A_{VMAX} = +100\text{ V/V}$ )

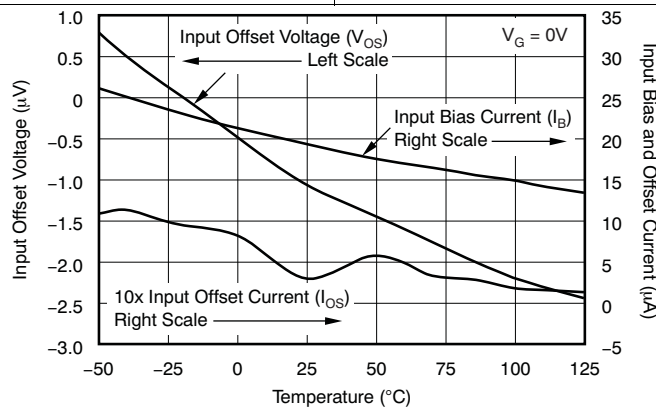
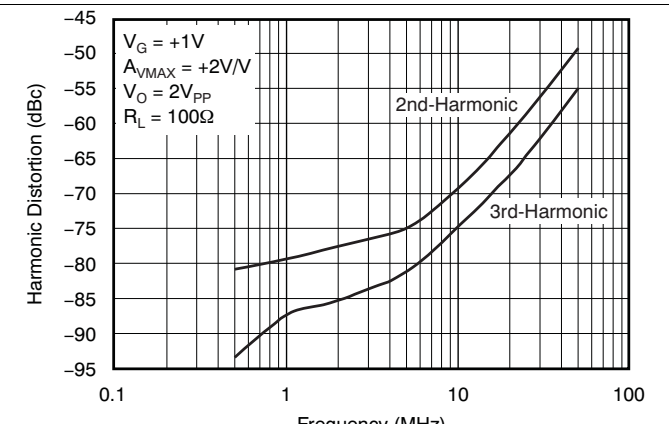
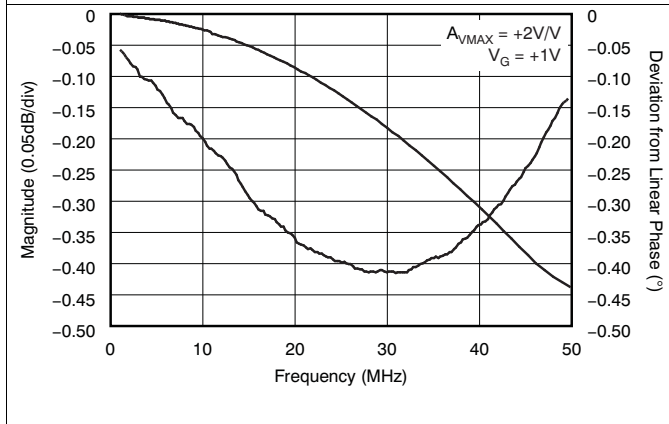
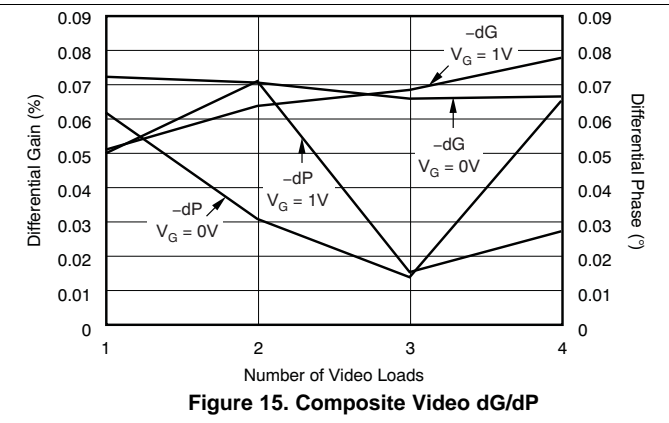
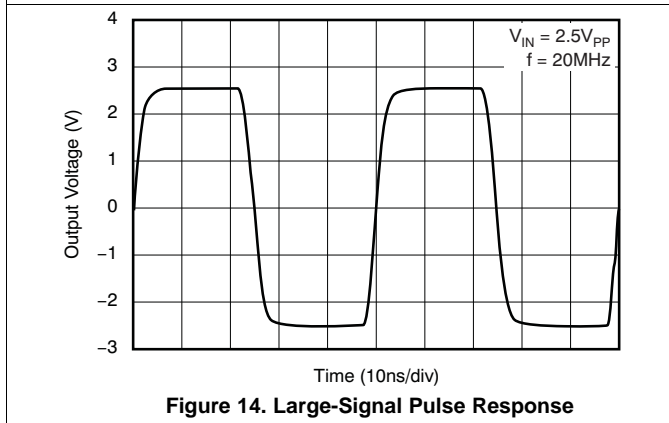
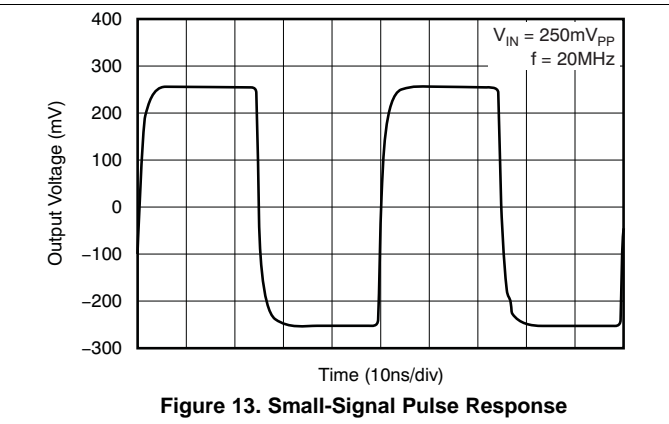
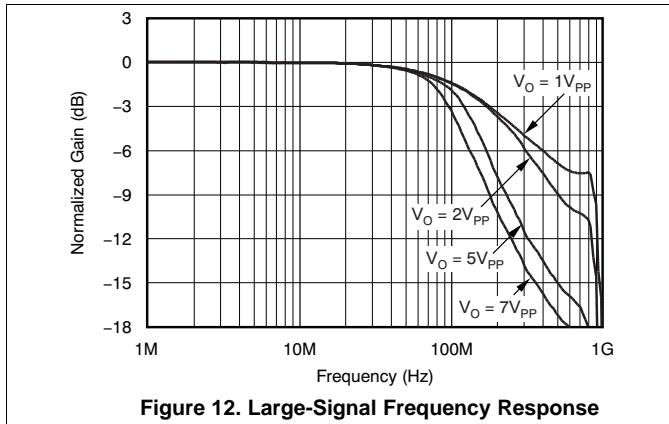

Figure 11. Typical DC Drift vs Temperature

### 7.8 Typical Characteristics: $V_S = \pm 5\text{ V}$ , $A_{VMAX} = +2\text{ V/V}$

At  $T_A = +25^\circ\text{C}$ ,  $R_L = 100\ \Omega$ ,  $R_F = 1.33\ \text{k}\Omega$ ,  $R_G = 1.33\ \text{k}\Omega$ ,  $V_G = +1\text{ V}$ ,  $V_{IN}$  = single-ended input on  $+V_{IN}$  with  $-V_{IN}$  at ground, and SOIC-14 package, unless otherwise noted.



**Typical Characteristics:  $V_S = \pm 5\text{ V}$ ,  $A_{VMAX} = +2\text{ V/V}$  (continued)**

At  $T_A = +25^\circ\text{C}$ ,  $R_L = 100\ \Omega$ ,  $R_F = 1.33\ \text{k}\Omega$ ,  $R_G = 1.33\ \text{k}\Omega$ ,  $V_G = +1\text{ V}$ ,  $V_{IN}$  = single-ended input on  $+V_{IN}$  with  $-V_{IN}$  at ground, and SOIC-14 package, unless otherwise noted.

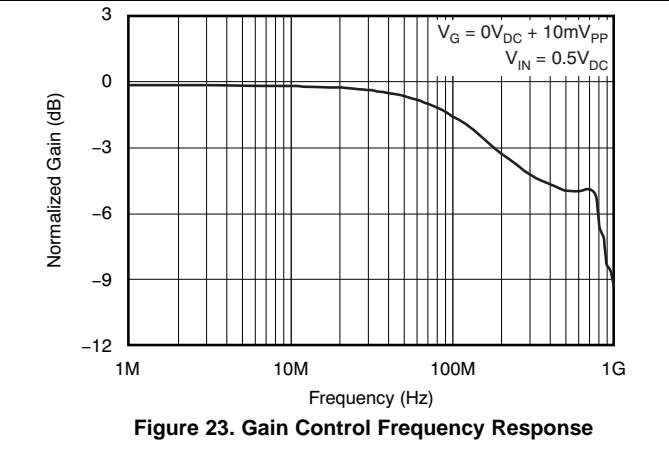
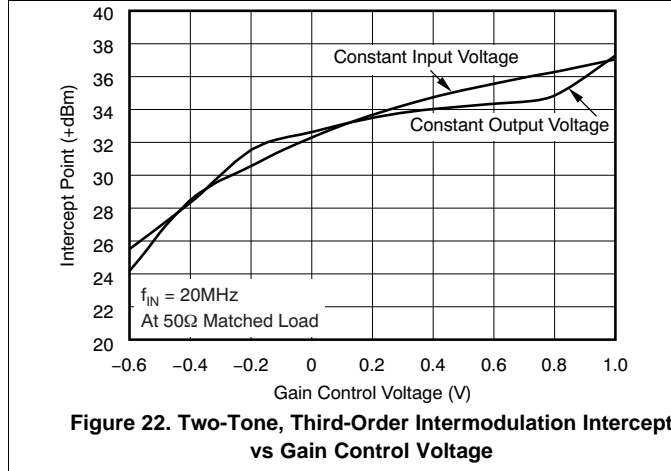
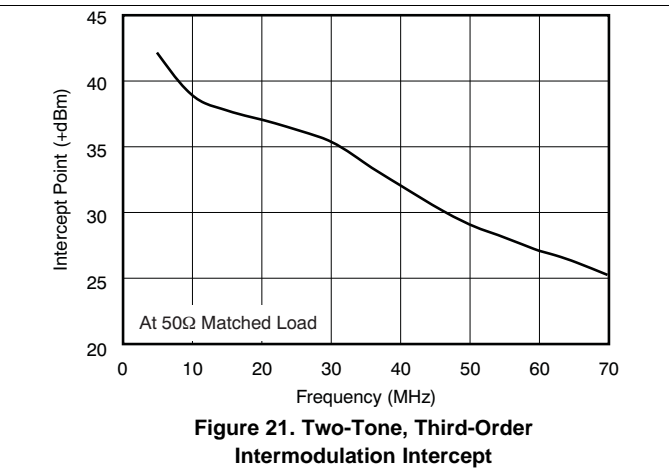
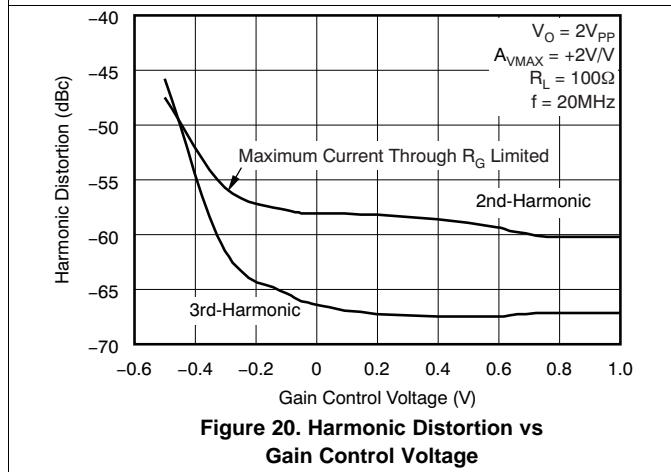
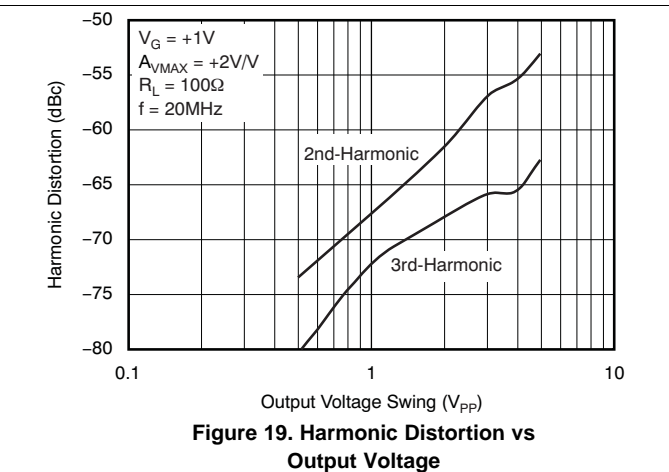
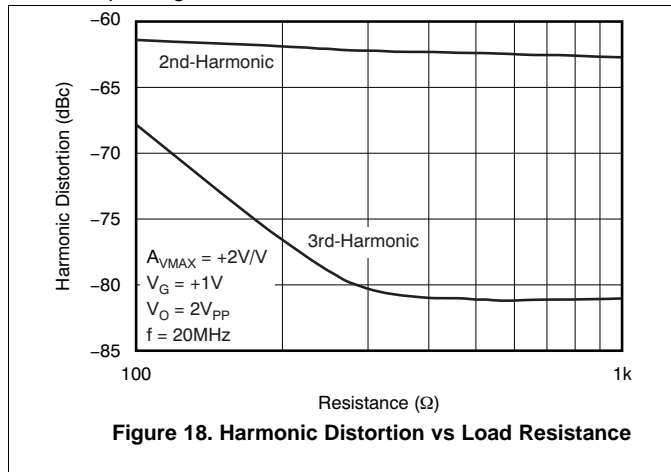

Typical Characteristics:  $V_S = \pm 5\text{ V}$ ,  $A_{VMAX} = +2\text{ V/V}$  (continued)

At  $T_A = +25^\circ\text{C}$ ,  $R_L = 100\ \Omega$ ,  $R_F = 1.33\ \text{k}\Omega$ ,  $R_G = 1.33\ \text{k}\Omega$ ,  $V_G = +1\text{ V}$ ,  $V_{IN}$  = single-ended input on  $+V_{IN}$  with  $-V_{IN}$  at ground, and SOIC-14 package, unless otherwise noted.

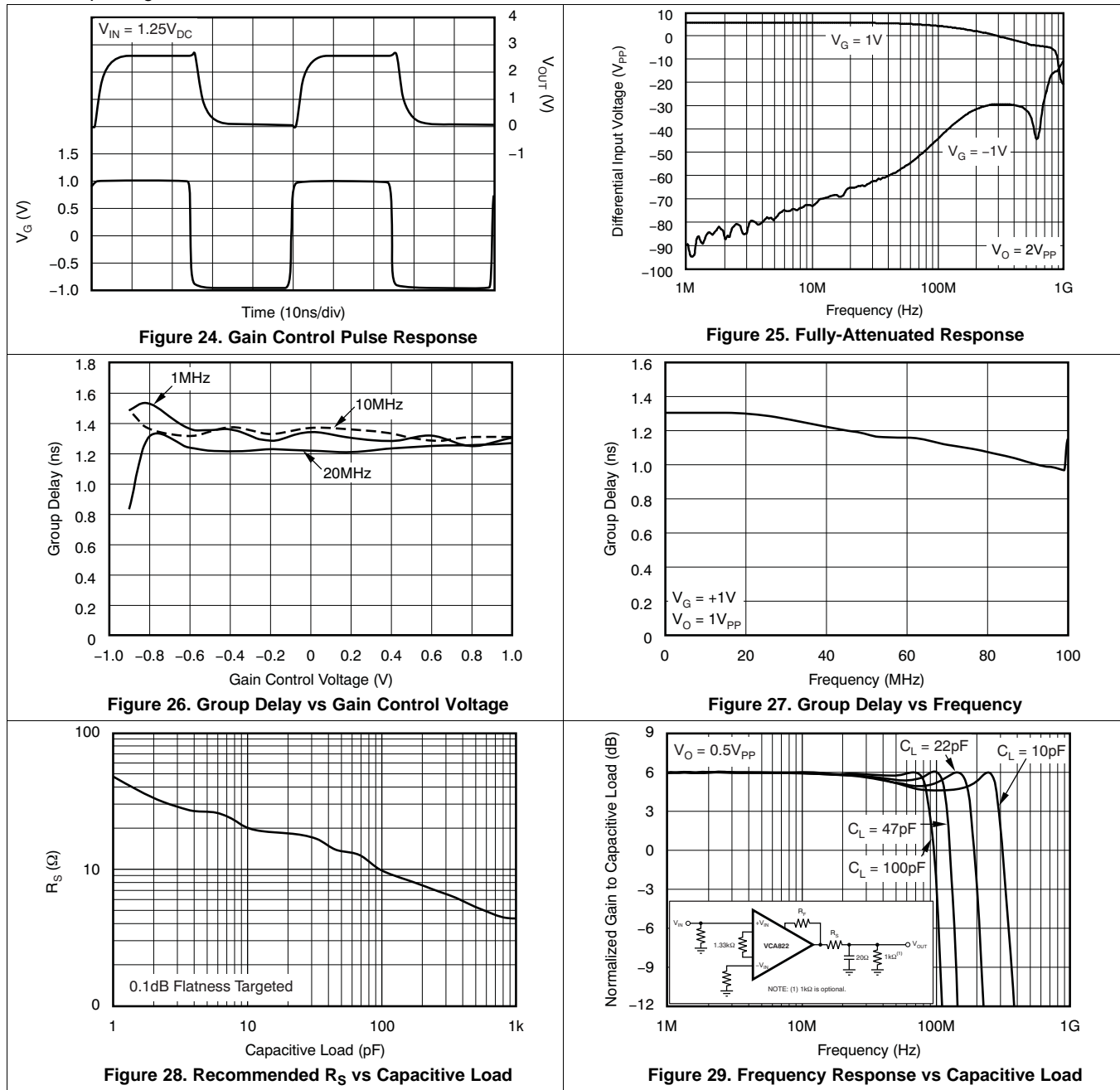

**Typical Characteristics:  $V_S = \pm 5\text{ V}$ ,  $A_{VMAX} = +2\text{ V/V}$  (continued)**

At  $T_A = +25^\circ\text{C}$ ,  $R_L = 100\ \Omega$ ,  $R_F = 1.33\ \text{k}\Omega$ ,  $R_G = 1.33\ \text{k}\Omega$ ,  $V_G = +1\ \text{V}$ ,  $V_{IN}$  = single-ended input on  $+V_{IN}$  with  $-V_{IN}$  at ground, and SOIC-14 package, unless otherwise noted.

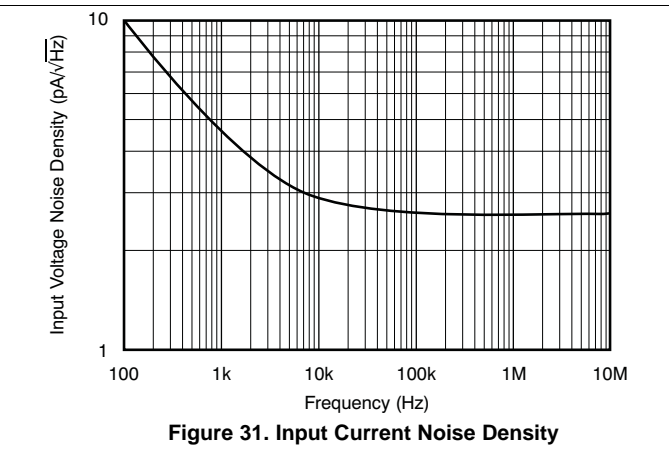
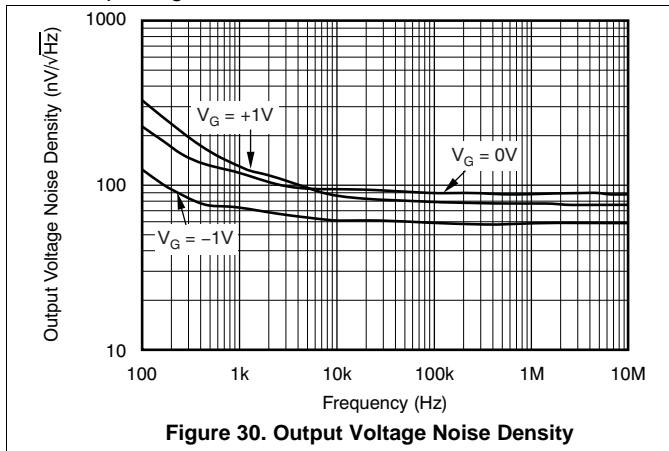

**7.9 Typical Characteristics:  $V_S = \pm 5\text{ V}$ ,  $A_{VMAX} = +10\text{ V/V}$**

At  $T_A = +25^\circ\text{C}$ ,  $R_L = 100\ \Omega$ ,  $R_F = 1\ \text{k}\Omega$ ,  $R_G = 200\ \Omega$ ,  $V_G = +1\ \text{V}$ , and  $V_{IN}$  = single-ended input on  $+V_{IN}$  with  $-V_{IN}$  at ground, unless otherwise noted.

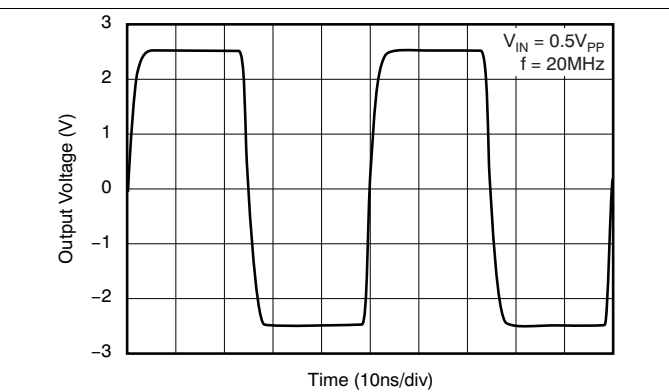
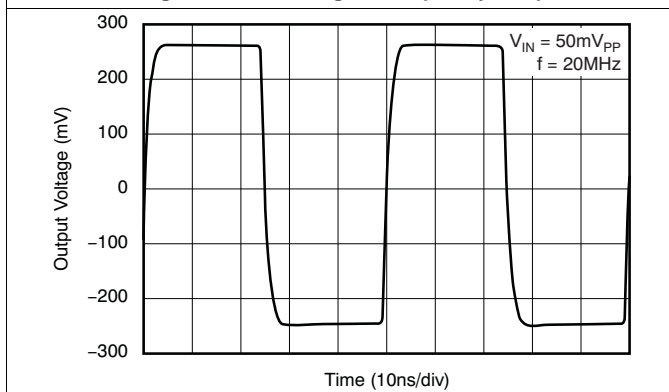
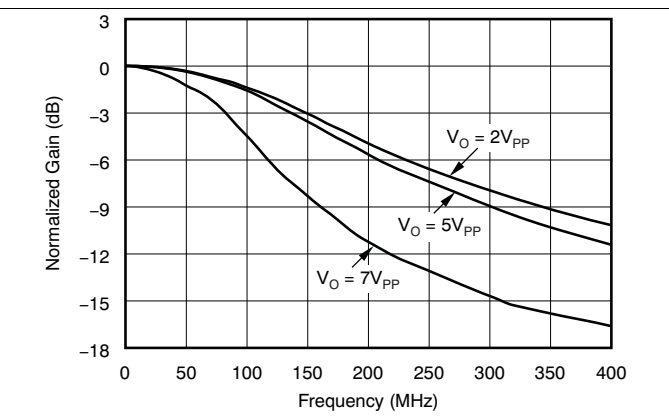
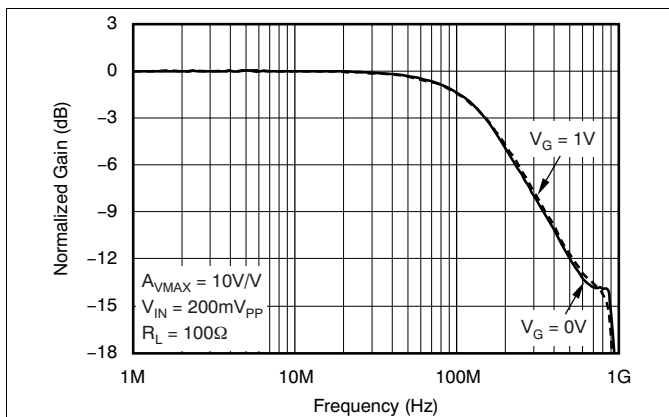

Typical Characteristics:  $V_S = \pm 5\text{ V}$ ,  $A_{VMAX} = +10\text{ V/V}$  (continued)

At  $T_A = +25^\circ\text{C}$ ,  $R_L = 100\ \Omega$ ,  $R_F = 1\text{ k}\Omega$ ,  $R_G = 200\ \Omega$ ,  $V_G = +1\text{ V}$ , and  $V_{IN} =$  single-ended input on  $+V_{IN}$  with  $-V_{IN}$  at ground, unless otherwise noted.

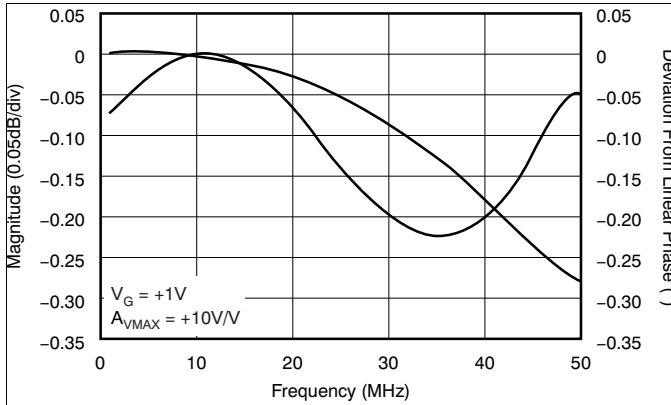

Figure 36. Gain Flatness, Deviation From Linear Phase

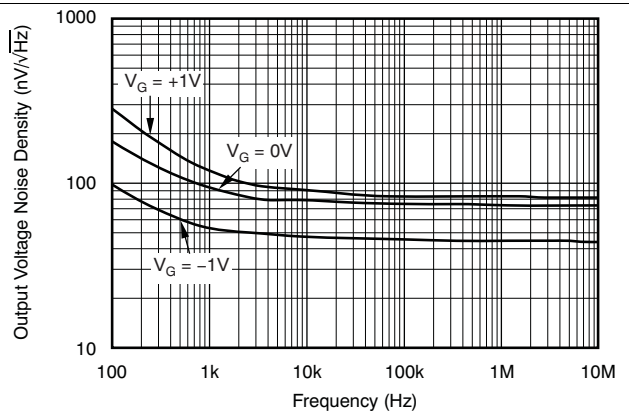

Figure 37. Output Voltage Noise Density

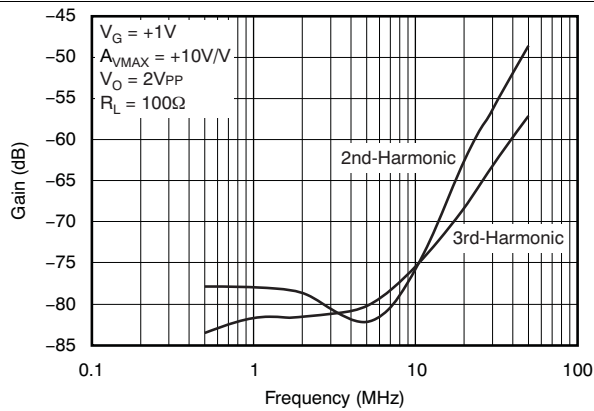

Figure 38. Harmonic Distortion vs Frequency

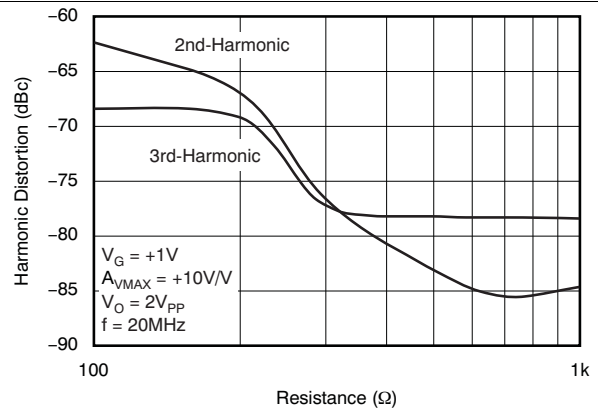

Figure 39. Harmonic Distortion vs Load Resistance

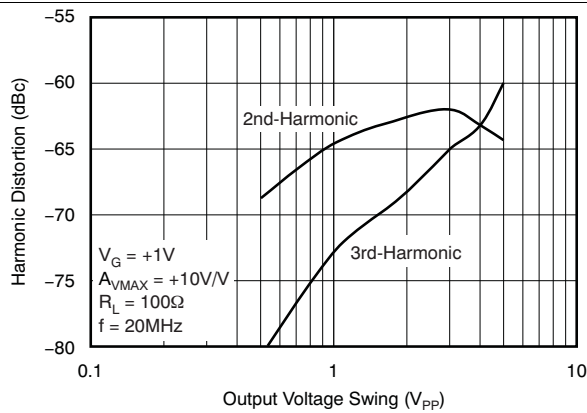

Figure 40. Harmonic Distortion vs Output Voltage

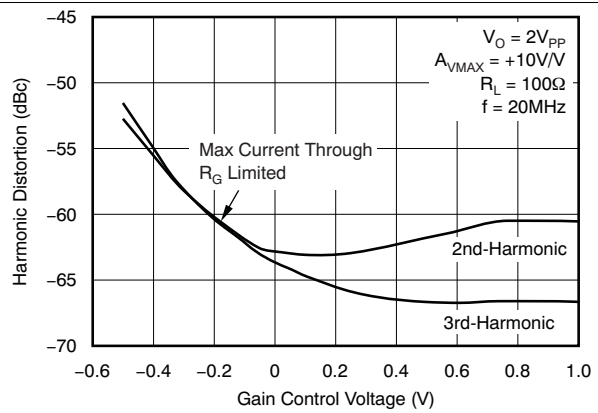

Figure 41. Harmonic Distortion vs Gain Control Voltage

Typical Characteristics:  $V_S = \pm 5\text{ V}$ ,  $A_{VMAX} = +10\text{ V/V}$  (continued)

At  $T_A = +25^\circ\text{C}$ ,  $R_L = 100\ \Omega$ ,  $R_F = 1\text{ k}\Omega$ ,  $R_G = 200\ \Omega$ ,  $V_G = +1\text{ V}$ , and  $V_{IN}$  = single-ended input on  $+V_{IN}$  with  $-V_{IN}$  at ground, unless otherwise noted.

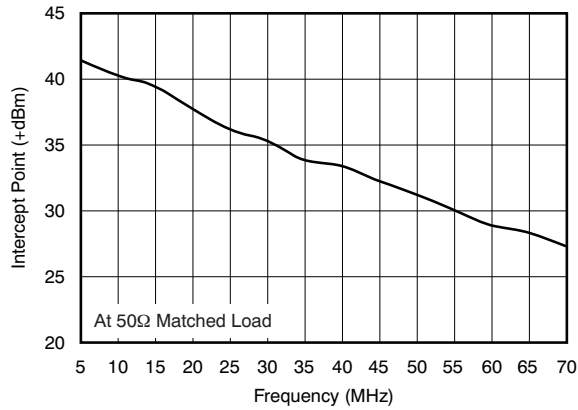

Figure 42. Two-Tone, Third-Order Intermodulation Intercept

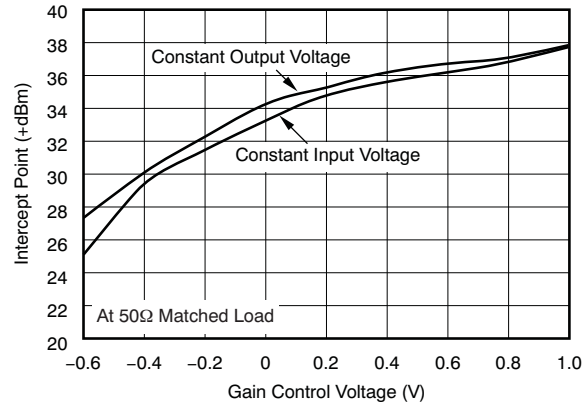

Figure 43. Two-Tone, Third-Order Intermodulation Intercept vs Gain Control Voltage ( $f_{IN} = 20\text{ MHz}$ )

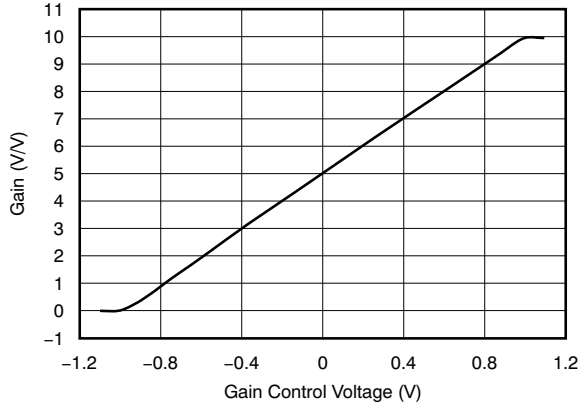

Figure 44. Gain vs Gain Control Voltage

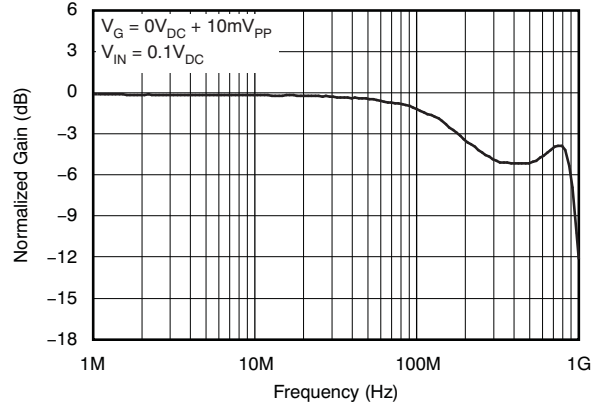

Figure 45. Gain Control Frequency Response

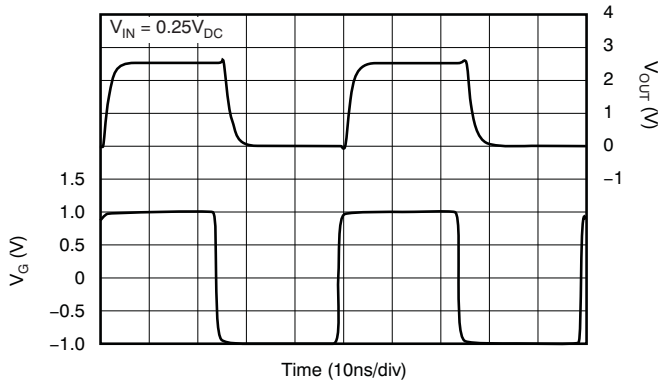

Figure 46. Gain Control Pulse Response

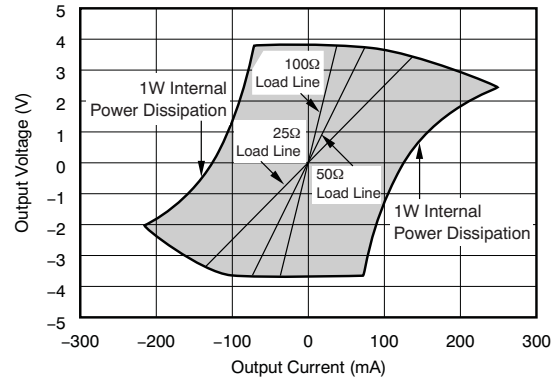
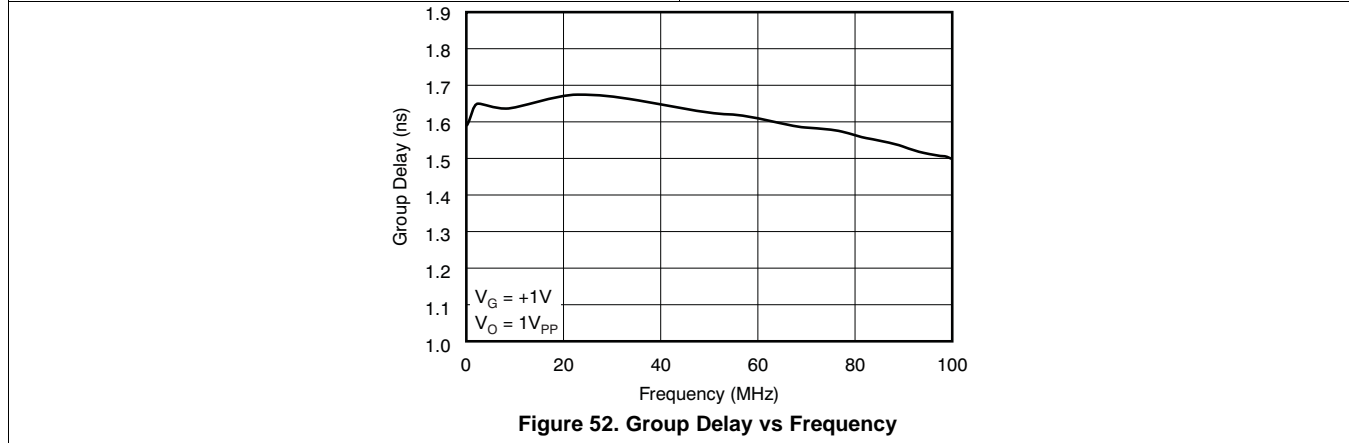
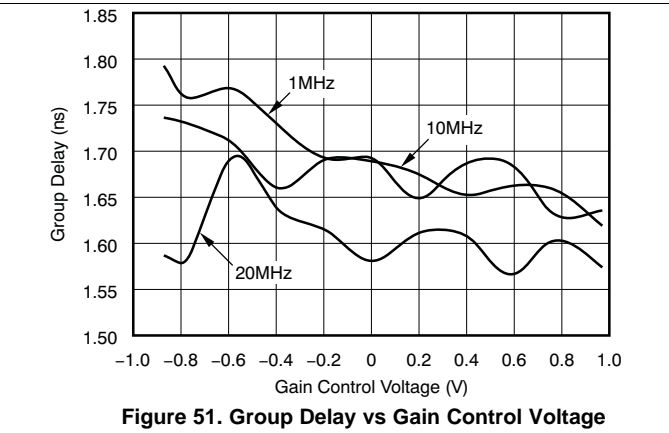
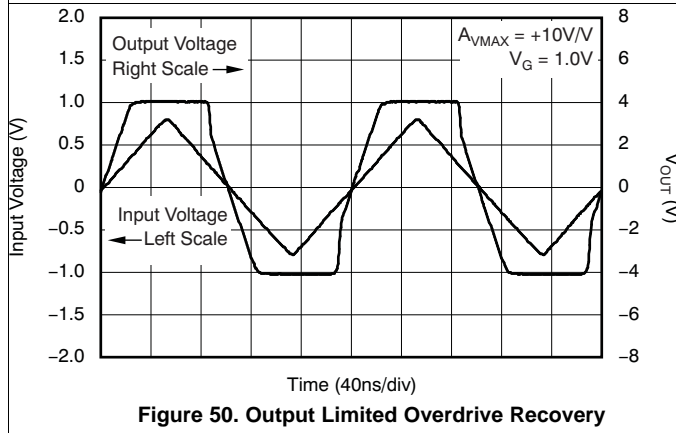
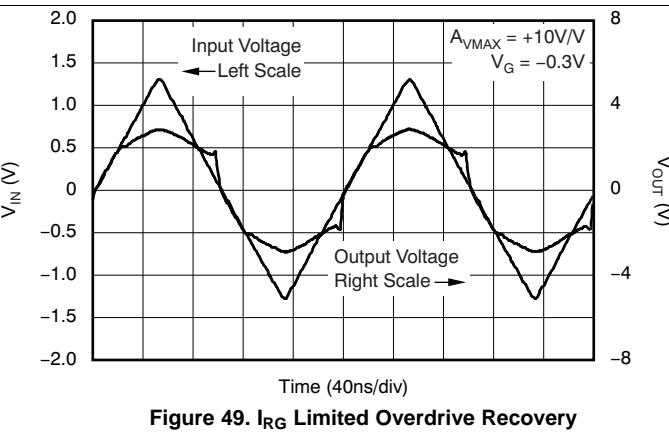
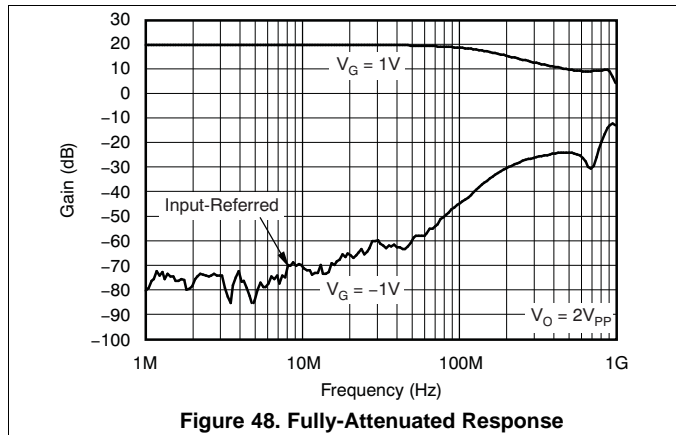

Figure 47. Output Voltage and Current Limitations



Typical Characteristics:  $V_S = \pm 5\text{ V}$ ,  $A_{VMAX} = +10\text{ V/V}$  (continued)

At  $T_A = +25^\circ\text{C}$ ,  $R_L = 100\ \Omega$ ,  $R_F = 1\text{ k}\Omega$ ,  $R_G = 200\ \Omega$ ,  $V_G = +1\text{ V}$ , and  $V_{IN} = \text{single-ended input on } +V_{IN} \text{ with } -V_{IN} \text{ at ground}$ , unless otherwise noted.



### 7.10 Typical Characteristics: $V_S = \pm 5\text{ V}$ , $A_{VMAX} = +100\text{ V/V}$

At  $T_A = +25^\circ\text{C}$ ,  $R_L = 100\ \Omega$ ,  $R_F = 845\ \Omega$ ,  $R_G = 16.9\ \Omega$ ,  $V_G = +1\text{ V}$ ,  $V_{IN}$  = single-ended input on  $+V_{IN}$  with  $-V_{IN}$  at ground, and SOIC-14 package, unless otherwise noted.

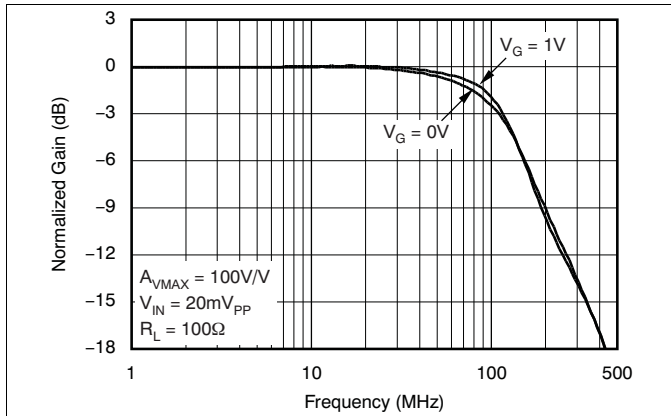

Figure 53. Small-Signal Frequency Response

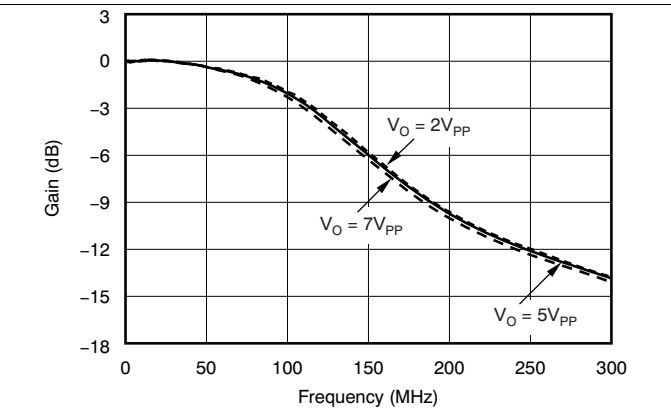

Figure 54. Large-Signal Frequency Response

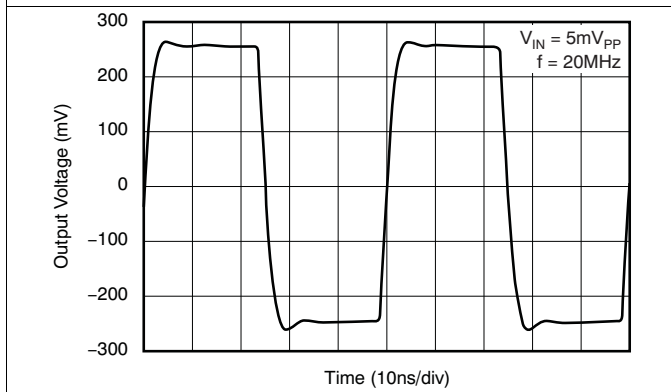

Figure 55. Small-Signal Pulse Response

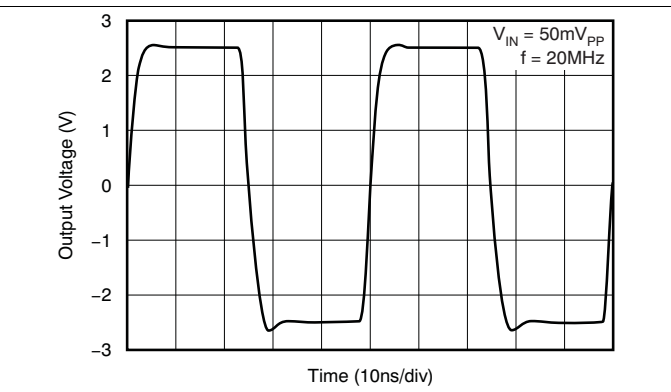

Figure 56. Large-Signal Pulse Response

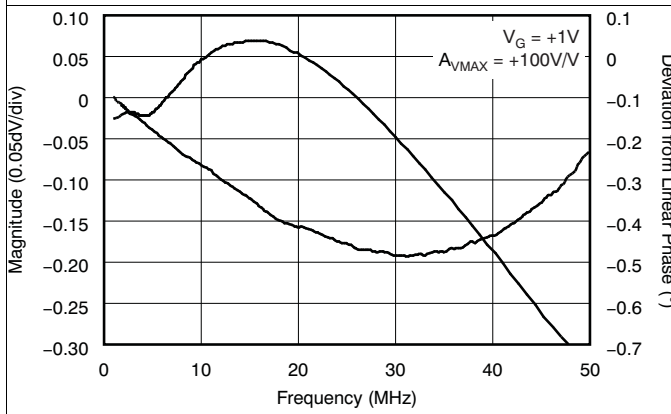

Figure 57. Gain Flatness

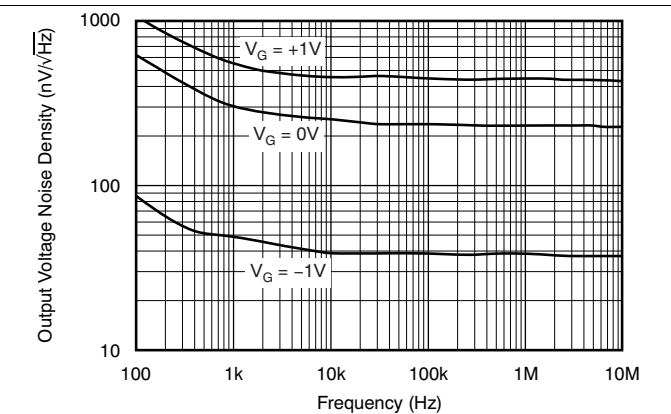

Figure 58. Output Voltage Noise Density

Typical Characteristics:  $V_S = \pm 5\text{ V}$ ,  $A_{VMAX} = +100\text{ V/V}$  (continued)

At  $T_A = +25^\circ\text{C}$ ,  $R_L = 100\ \Omega$ ,  $R_F = 845\ \Omega$ ,  $R_G = 16.9\ \Omega$ ,  $V_G = +1\text{ V}$ ,  $V_{IN}$  = single-ended input on  $+V_{IN}$  with  $-V_{IN}$  at ground, and SOIC-14 package, unless otherwise noted.

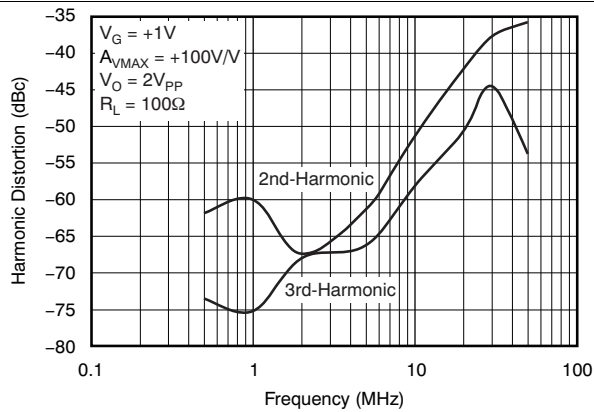

Figure 59. Harmonic Distortion vs Frequency

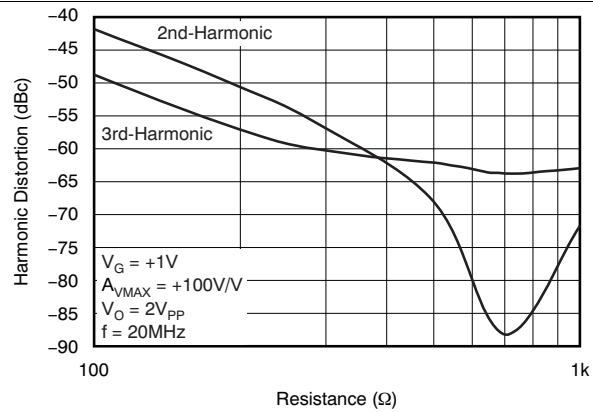

Figure 60. Harmonic Distortion vs Load Resistance

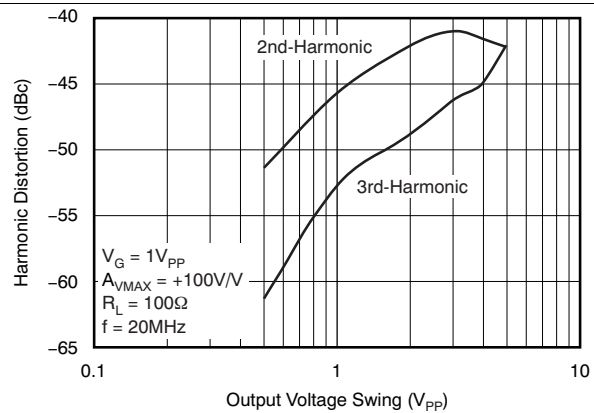

Figure 61. Harmonic Distortion vs Output Voltage

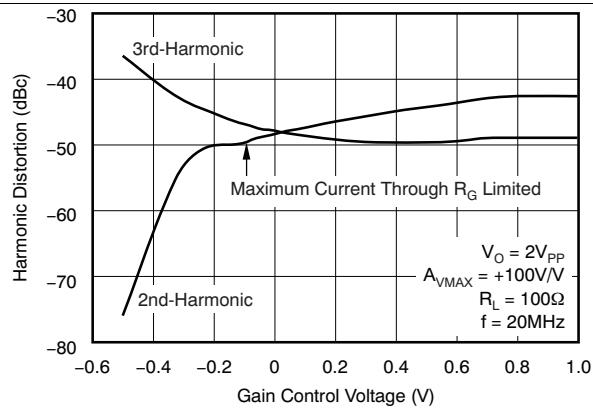

Figure 62. Harmonic Distortion vs Gain Control Voltage

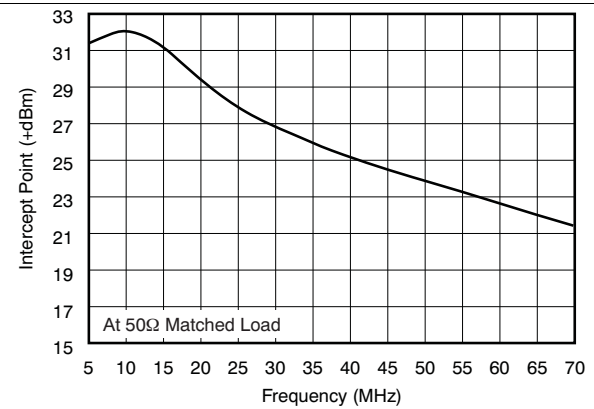

Figure 63. Two-Tone, Third-Order Intermodulation Intercept

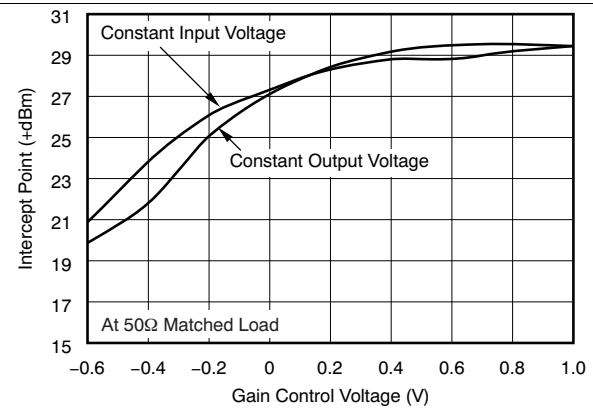
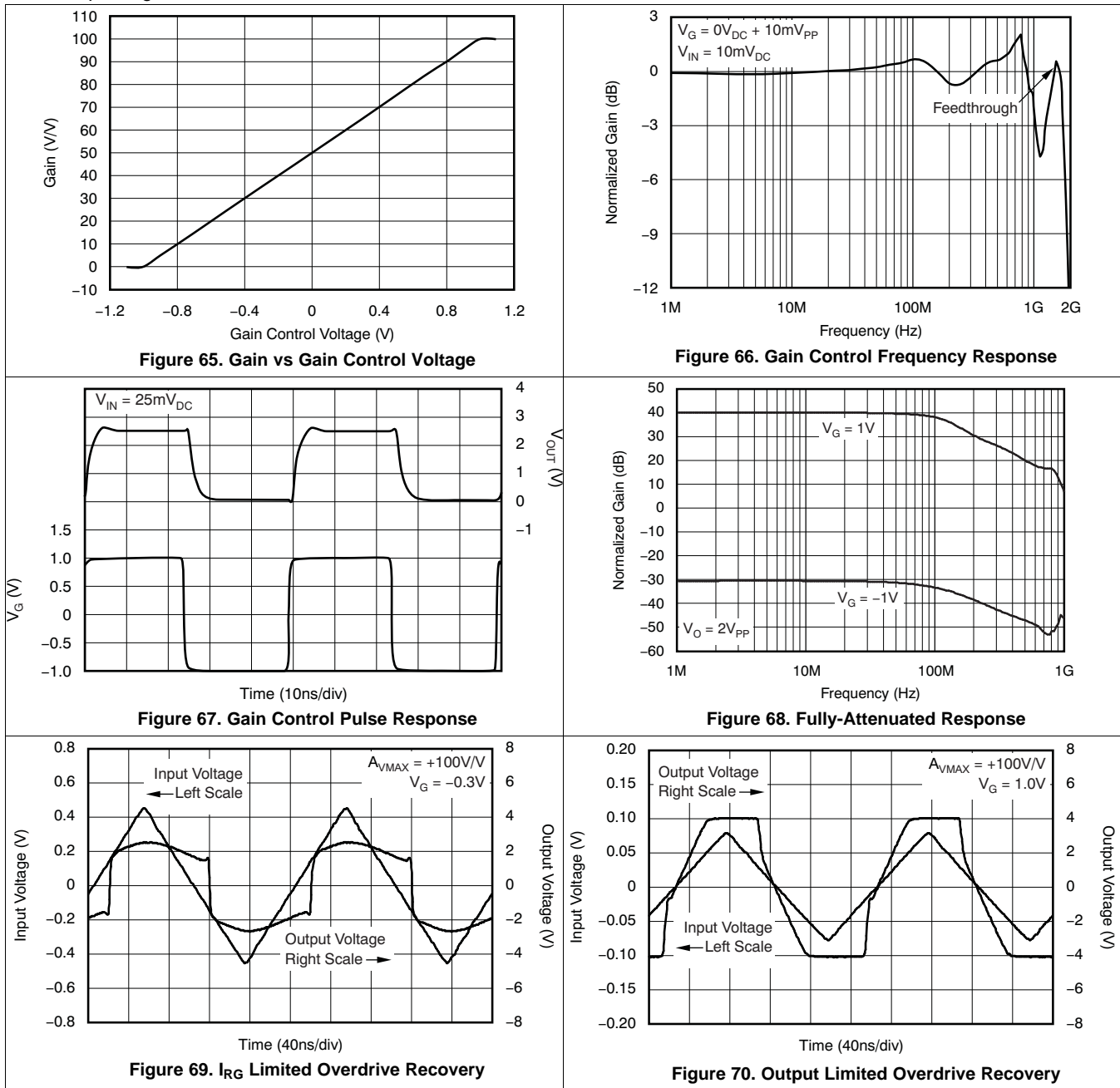

Figure 64. Two-Tone, Third-Order Intermodulation Intercept vs Gain Control Voltage ( $f_{IN} = 20\text{ MHz}$ )

**Typical Characteristics:  $V_S = \pm 5\text{ V}$ ,  $A_{VMAX} = +100\text{ V/V}$  (continued)**

At  $T_A = +25^\circ\text{C}$ ,  $R_L = 100\ \Omega$ ,  $R_F = 845\ \Omega$ ,  $R_G = 16.9\ \Omega$ ,  $V_G = +1\text{ V}$ ,  $V_{IN}$  = single-ended input on  $+V_{IN}$  with  $-V_{IN}$  at ground, and SOIC-14 package, unless otherwise noted.



**Typical Characteristics:  $V_S = \pm 5\text{ V}$ ,  $A_{V_{MAX}} = +100\text{ V/V}$  (continued)**

At  $T_A = +25^\circ\text{C}$ ,  $R_L = 100\ \Omega$ ,  $R_F = 845\ \Omega$ ,  $R_G = 16.9\ \Omega$ ,  $V_G = +1\text{ V}$ ,  $V_{IN}$  = single-ended input on  $+V_{IN}$  with  $-V_{IN}$  at ground, and SOIC-14 package, unless otherwise noted.

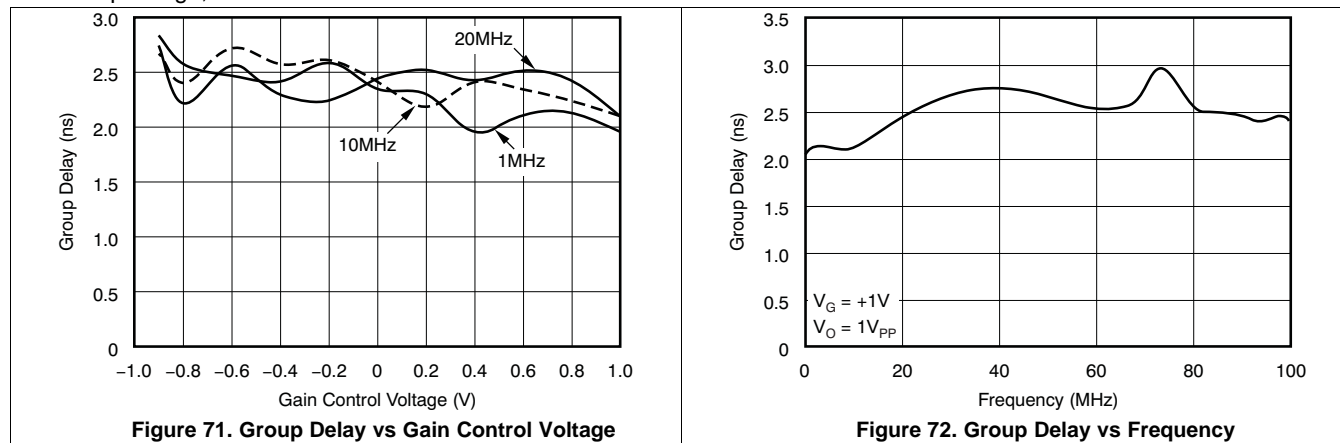

**8 Parameter Measurement Information**

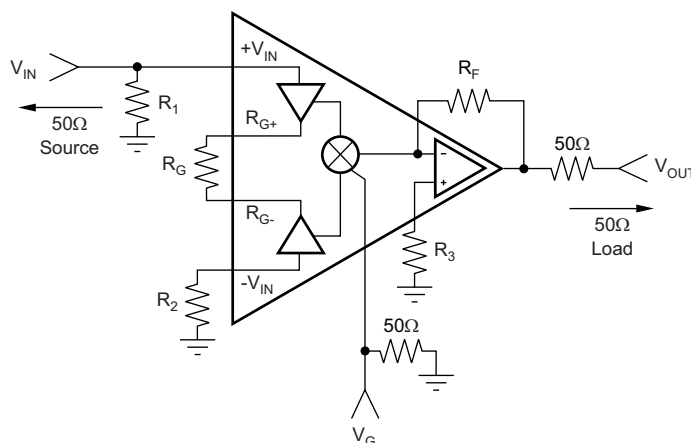

**Figure 73. Test Circuit**

## 9 Detailed Description

### 9.1 Overview

The VCA822 is a voltage controlled variable gain amplifier with differential inputs and a single ended output. The maximum gain is set by external resistors while the gain range is controlled by an external analog voltage. The maximum gain is designed for gains of 2 V/V up to 100 V/V and the analog control allows a gain range of over 40 dB. The VCA822 input consists of two buffers which together create a fully symmetrical, high impedance differential input with a typical common mode rejection of 80 dB. The gain set resistor is connected between the two input buffer output pins, so that the input impedance is independent of the gain settings. The bipolar inputs have a input voltage range of +1.6 and –2.1 V on ±5 V supplies. The amplifier maximum gain is set by external resistors, but the internal gain control circuit is controlled by a continuously variable, analog voltage. The gain control is a multiplier stage which is linear in V/V. The gain control input pin operates over a 2-V voltage range (–1 V to +1 V). The VCA822 contains a high speed, high current output buffer. The output stage can typically swing ±3.9 V and source/sink ±160 mA. The VCA822 can be operated over a voltage range of ±3.5 V to ±6 V.

### 9.2 Feature Description

The VCA822 can be operated with both single ended or differential input signals. The inputs present consistently high impedance across all gain configurations. By using an analog control signal the amplifier gain is continuously variable for smooth, glitch free gain changes. With a large signal bandwidth of 137 Mhz and a slew rate of 1700 V/us the VCA822 offers linear performance over a wide range of signal amplitudes and gain settings. The low impedance/high current output buffer can drive loads ranging from low impedance transmission lines to high-impedance, switched-capacitor analog to digital converters. By using closely matched internal components the VCA822 offers a typical gain accuracy of ±0.1 dB.

### 9.3 Device Functional Modes

The VCA822 functions as a differential input, single-ended output variable gain amplifier. This functional mode is enabled by applying power to the amplifier supply pins and is disabled by turning the power off.

The gain is continuously variable through the analog gain control input. While the gain range is fixed the maximum gain is set by two external components, R<sub>f</sub> and R<sub>g</sub> as shown in the [Parameter Measurement Information](#). The maximum gain is equal to 2x (R<sub>f</sub> / R<sub>g</sub>). This gain is achieved with a 2-V voltage on the gain adjust pin VG. As the voltage decreases on the VG pin, the gain decreases in a linear in dB fashion with over 40 dB of gain range from 2-V to 0-V control voltage.

As with most other differential input amplifiers, inputs can be applied to either one or both of the amplifier inputs. The amplifier gain is controlled through the gain control pin.

#### 9.3.1 Maximum Gain of Operation

This section describes the use of the VCA822 device in a fixed-gain application in which the V<sub>G</sub> control pin is set at V<sub>G</sub> = +1 V. The tradeoffs described here are with bandwidth, gain, and output voltage range.

In the case of an application that does not make use of the V<sub>GAIN</sub>, but requires some other characteristic of the VCA822, the R<sub>G</sub> resistor must be set such that the maximum current flowing through the resistance I<sub>RG</sub> is less than ±2.6 mA typical, or 5.2 mA<sub>PP</sub> as defined in [Electrical Characteristics: V<sub>S</sub> = ±5 V](#), and must follow [Equation 1](#).

$$I_{RG} = \frac{V_{OUT}}{A_{VMAX} \times R_G} \quad (1)$$

As demonstrated by [Equation 1](#), when the output dynamic range and maximum gain are defined, the gain resistor is set. This gain setting in turn affects the bandwidth because in order to achieve the gain (and with a set gain element), the feedback element of the output stage amplifier is set as well. Keeping in mind that the output amplifier of the VCA822 device is a current-feedback amplifier, the larger the feedback element, the lower the bandwidth as the feedback resistor is the compensation element.

Limiting the discussion to the input voltage only and ignoring the output voltage and gain, [Figure 1](#) illustrates the tradeoff between the input voltage and the current flowing through the gain resistor.

## Device Functional Modes (continued)

### 9.3.2 Output Current and Voltage

The VCA822 device provides output voltage and current capabilities that are unsurpassed in a low-cost monolithic VCA. Under no-load conditions at +25°C, the output voltage typically swings closer than 1 V to either supply rails; the +25°C swing limit is within 1.2 V of either rails. Into a 15-Ω load (the minimum tested load), it is tested to deliver more than ±160 mA.

The specifications described previously, though familiar in the industry, consider voltage and current limits separately. In many applications, it is the voltage × current, or *V-I product*, that is more relevant to circuit operation. Refer to the *Output Voltage and Current Limitations* plot (Figure 47) in the *Typical Characteristics* section. The X-axis and Y-axis of this graph show the zero-voltage output current limit and the zero-current output voltage limit, respectively. The four quadrants give a more detailed view of the VCA822 device output drive capabilities, noting that the graph is bounded by a *Safe Operating Area* of 1-W maximum internal power dissipation. Superimposing resistor load lines onto the plot shows that the VCA822 device can drive ±2.5 V into 25 Ω or ±3.5 V into 50 Ω without exceeding the output capabilities or the 1 W dissipation limit. A 100-Ω load line (the standard test circuit load) shows the full ±3.9 V output swing capability, as shown in the *Typical Characteristics*.

The minimum specified output voltage and current over-temperature are set by worst-case simulations at the cold temperature extreme. Only at cold start-up do the output current and voltage decrease to the numbers shown in *Electrical Characteristics:  $V_S = \pm 5$  V*. As the output transistors deliver power, the respective junction temperatures increase, increasing the available output voltage swing, and increasing the available output current. In steady-state operation, the available output voltage and current is always greater than that temperature shown in the over-temperature specifications because the output stage junction temperatures are higher than the specified operating ambient.

### 9.3.3 Input Voltage Dynamic Range

The VCA822 device has a input dynamic range limited to +1.6 V and –2.1 V. Increasing the input voltage dynamic range can be done by using an attenuator network on the input. If the VCA822 device is trying to regulate the amplitude at the output, such as in an AGC application, the input voltage dynamic range is directly proportional to Equation 2.

$$V_{IN(PP)} = R_G \times I_{RG(PP)} \quad (2)$$

As such, for unity-gain or under-attenuated conditions, the input voltage must be limited to the CMIR of ±1.6 V (3.2 V<sub>PP</sub>) and the current (I<sub>RQ</sub>) must flow through the gain resistor, ±2.6 mA (5.2 mA<sub>PP</sub>). This configuration sets a minimum value for R<sub>E</sub> such that the gain resistor has to be greater than Equation 3.

$$R_{GMIN} = \frac{3.2V_{PP}}{5.2mA_{PP}} = 615.4\Omega \quad (3)$$

Values lower than 615.4Ω are gain elements that result in reduced input range, as the dynamic input range is limited by the current flowing through the gain resistor R<sub>G</sub> (I<sub>RG</sub>). If the I<sub>RG</sub> current is limiting the performance of the circuit, the input stage of the VCA822 device goes into overdrive, resulting in limited output voltage range. Such I<sub>RG</sub>-limited overdrive conditions are shown in Figure 49 for the gain of +10 V/V and Figure 69 for the +100 V/V gain.

### 9.3.4 Output Voltage Dynamic Range

With its large output current capability and its wide output voltage swing of ±3.9-V typical on a 100-Ω load, it is easy to forget other types of limitations that the VCA822 device can encounter. For these limitations, careful analysis must be done to avoid input stage limitation, either voltage or I<sub>RG</sub> current; also, consider the gain limitation, as the control pin V<sub>G</sub> varies, affecting other aspects of the circuit.

### 9.3.5 Bandwidth

The output stage of the VCA822 device is a wideband current-feedback amplifier. As such, the feedback resistance is the compensation of the last stage. Reducing the feedback element and maintaining the gain constant limits the useful range of I<sub>RG</sub>, and therefore reducing the gain adjust range. For a given gain, reducing the gain element limits the maximum achievable output voltage swing.

## Device Functional Modes (continued)

### 9.3.6 Offset Adjustment

As a result of the internal architecture used on the VCA822 device, the output offset voltage originates from the output stage and from the input stage and multiplier core. [Figure 91](#) shows how to compensate both sources of the output offset voltage. Use this procedure to compensate the output offset voltage: starting with the output stage compensation, set  $V_G = -1$  V to eliminate all offset contribution of the input stage and multiplier core. Adjust the output stage offset compensation potentiometer. Finally, set  $V_G = +1$  V to the maximum gain and adjust the input stage and multiplier core potentiometer. This procedure effectively eliminates all offset contribution at the maximum gain. Because adjusting the gain modifies the contribution of the input stage and the multiplier core, some residual output offset voltage remains.

### 9.3.7 Noise

The VCA822 device offers 8.2 nV/ $\sqrt{\text{Hz}}$  input-referred voltage noise density at a gain of +10 V/V and 1.8 pA/ $\sqrt{\text{Hz}}$  input-referred current noise density. The input-referred voltage noise density considers that all noise terms, except the input current noise but including the thermal noise of both the feedback resistor and the gain resistor, are expressed as one term.

This model is formulated in [Equation 4](#) and [Figure 90](#).

$$e_o = A_{V_{MAX}} \times \sqrt{2 \times (R_s \times i_n)^2 + e_n^2 + 2 \times 4kTR_s} \tag{4}$$

A more complete model is shown in [Figure 92](#). For additional information on this model and the actual modeled noise terms, please contact the High-Speed Product Application Support team at [www.ti.com](http://www.ti.com).

### 9.3.8 Input and ESD Protection

The VCA822 device is built using a very high-speed complementary bipolar process. The internal junction breakdown voltages are relatively low for these very small geometry devices. These breakdowns are reflected in [Absolute Maximum Ratings](#).

All pins on the VCA822 device are internally protected from ESD by means of a pair of back-to-back reverse-biased diodes to either power supply, as shown in [Figure 74](#). These diodes begin to conduct when the pin voltage exceeds either power supply by about 0.7 V. This situation can occur with loss of the amplifier power supplies while a signal source is still present. The diodes can typically withstand a continuous current of 30 mA without destruction. To ensure long-term reliability, however, diode current should be externally limited to 10 mA whenever possible.

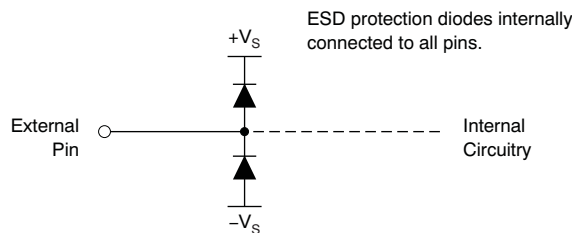

**Figure 74. Internal ESD Protection**



## 10 Application and Implementation

### NOTE

Information in the following applications sections is not part of the TI component specification, and TI does not warrant its accuracy or completeness. TI's customers are responsible for determining suitability of components for their purposes. Customers should validate and test their design implementation to confirm system functionality.

### 10.1 Application Information

The VCA822 has flexible maximum gain which is set by the  $R_f$  and  $R_g$  resistors shown in [Parameter Measurement Information](#). The maximum gain is equal to  $2x (R_f / R_g)$ . This gain is achieved with a 2-V voltage on the gain adjust pin VG. As the voltage decreases on the VG pin, the gain decreases in a linear in dB fashion with over 40 dB of gain range from 2-V to 0-V control voltage.

#### 10.1.1 Design-In Tools

##### 10.1.1.1 Demonstration Boards

Two printed circuit boards (PCBs) are available to assist in the initial evaluation of circuit performance using the VCA822 device in the two package options. Both of these are offered from [ti.com](#) as unpopulated PCBs, delivered with a user's guide. The summary information for these fixtures is shown in [Table 1](#).

**Table 1. EVM Ordering Information**

PRODUCT	PACKAGE	BOARD PART NUMBER	LITERATURE NUMBER
VCA822ID	SOIC-14	DEM-VCA-SO-1B	<a href="#">SBOU050</a>
VCA822IDGS	MSOP-10	DEM-VCA-MSOP-1A	<a href="#">SBOU051</a>

The demonstration fixtures can be requested at the TI's web site through the [VCA822](#) device product folder.

##### 10.1.1.2 Macromodels and Applications Support

Computer simulation of circuit performance using SPICE is often useful when analyzing the performance of analog circuits and systems. This principle is particularly true for video and RF amplifier circuits where parasitic capacitance and inductance can play a major role in circuit performance. A [SPICE model](#) for the VCA822 device is available through the TI web page. The applications group is also available for design assistance. The models available from TI predict typical small-signal ac performance, transient steps, dc performance, and noise under a wide variety of operating conditions. The models include the noise terms found in the electrical specifications of the relevant product data sheet.

##### 10.1.1.3 Operating Suggestions

Operating the VCA822 device optimally for a specific application requires trade-offs between bandwidth, input dynamic range and the maximum input voltage, the maximum gain of operation and gain, output dynamic range and the maximum input voltage, the package used, loading, and layout and bypass recommendations. The [Typical Characteristics](#) have been defined to cover as much ground as possible to describe the VCA822 device operation. There are four sections in the Typical Characteristics:

- $V_S = \pm 5\text{ V}$  [DC Parameters](#) and  $V_S = \pm 5\text{ V}$  [DC and Power-Supply Parameters](#), which include dc operation and the intrinsic limitation of a VCA822 device design
- $V_S = \pm 5\text{ V}$ ,  $A_{VMAX} = +2\text{ V/V}$  [Gain of +2V/V Operation](#)
- $V_S = \pm 5\text{ V}$ ,  $A_{VMAX} = +10\text{ V/V}$  [Gain of +10V/V Operation](#)
- $V_S = \pm 5\text{ V}$ ,  $A_{VMAX} = +100\text{ V/V}$  [Gain of +100V/V Operation](#)

Where the [Typical Characteristics](#) describe the actual performance that can be achieved by using the amplifier properly, the following sections describe in detail the trade-offs needed to achieve this level of performance.

**10.1.1.4 Package Considerations**

The VCA822 device is available in both SOIC-14 and MSOP-10 packages. Each package has, for the different gains used in the typical characteristics, different values of  $R_F$  and  $R_G$  to achieve the same performance detailed in *Electrical Characteristics:  $V_S = \pm 5 V$* .

Figure 73 shows a test gain circuit for the VCA822 device. Table 2 lists the recommended configuration for the SOIC-14 and MSOP-10 package.

**Table 2. SOIC-14 and MSOP-10  $R_F$  and  $R_G$  Configurations**

	G = 2	G = 10	G = 100
$R_F$	1.33 k $\Omega$	1 k $\Omega$	845 $\Omega$
$R_G$	1.33 k $\Omega$	200 $\Omega$	16.9 $\Omega$

There are no differences between the packages in the recommended values for the gain and feedback resistors. However, the bandwidth for the VCA822IDGS (MSOP-10 package) is lower than the bandwidth for the VCA822ID (SOIC-14 package). This difference is true for all gains, but especially true for gains greater than 5 V/V, as can be seen in Figure 75 and Figure 76.

**NOTE**

The scale must be changed to a linear scale to view the details.

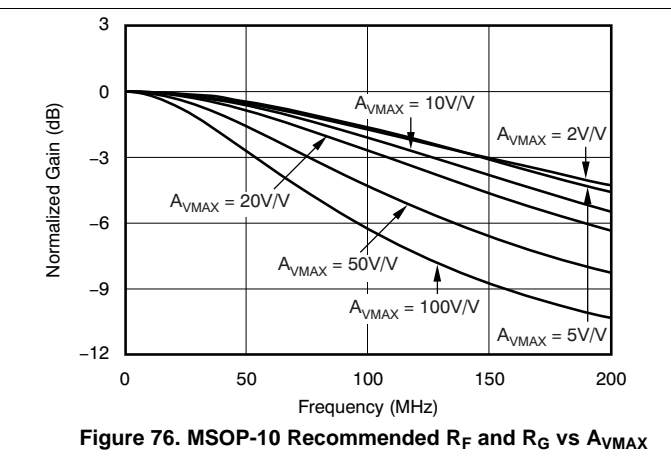
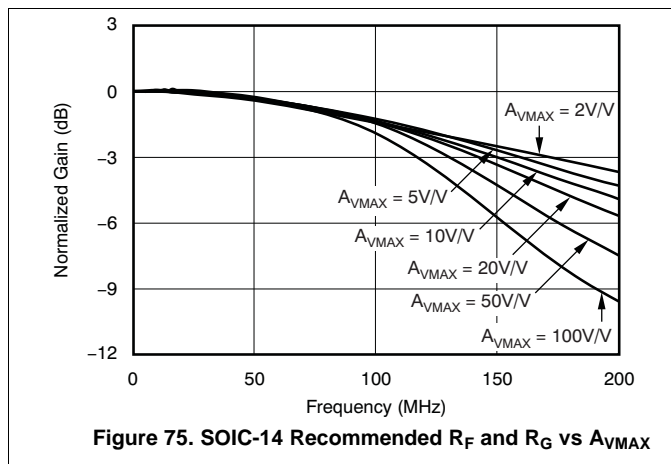

## 10.2 Typical Applications

### 10.2.1 Wideband Variable Gain Amplifier Operation Application

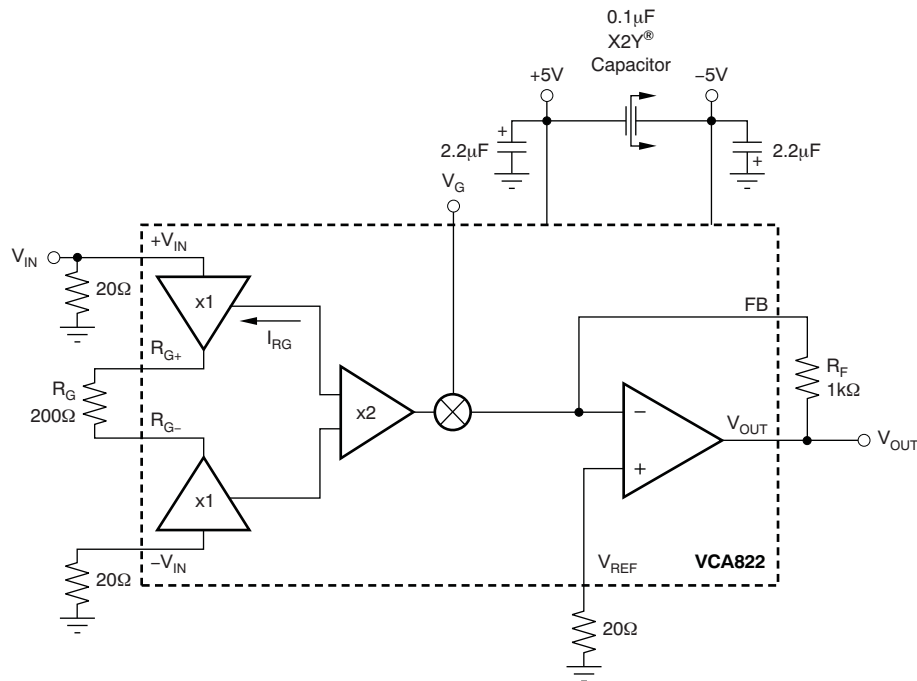

Figure 77. DC-Coupled,  $A_{V_{MAX}} = +10$  V/V, Bipolar Supply Specification and Test Circuit

#### 10.2.1.1 Design Requirements

The design shown in Figure 77 requires a single-ended input, continuously variable gain control and a single-ended output. This configuration is used to achieve the best performance with a bipolar supply. This circuit also requires a maximum gain of 10 V/V and low noise.

#### 10.2.1.2 Detailed Design Procedure

The VCA822 device provides an exceptional combination of high output power capability with a wideband, greater than 40-dB gain adjust range, linear in V/V variable gain amplifier. The input stage of the VCA822 device places the transconductance element between two input buffers, using the output currents as the forward signal. As the differential input voltage rises, a signal current is generated through the gain element. This current is then mirrored and gained by a factor of two before reaching the multiplier. The other input of the multiplier is the voltage gain control pin,  $V_G$ . Depending on the voltage present on  $V_G$ , up to two times the gain current is provided to the transimpedance output stage. The transimpedance output stage is a current-feedback amplifier providing high output current capability and high slew rate, 1700 V/ $\mu$ s. This exceptional full-power performance comes at the price of a relatively high quiescent current (36 mA), but a low input voltage noise for this type of architecture (8.2 nV/ $\sqrt{\text{Hz}}$ ).

Figure 77 shows the dc-coupled, gain of +10 V/V, dual power-supply circuit used as the basis of the  $\pm 5$  V *Electrical Characteristics:  $V_S = \pm 5$  V* and *Typical Characteristics:  $V_S = \pm 5$  V, DC Parameters*. For test purposes, the input impedance is set to 50  $\Omega$  with a resistor to ground and the output impedance is set to 50  $\Omega$  with a series output resistor. Voltage swings reported in *Electrical Characteristics:  $V_S = \pm 5$  V* are taken directly at the input and output pins, while output power (dBm) is at the matched 50- $\Omega$  load. For the circuit in Figure 77, the total effective load is 100  $\Omega$  || 1 k $\Omega$ .

**NOTE**

For the SOIC-14 package, there is a voltage reference pin,  $V_{REF}$  (pin 9). For the SOIC-14 package, this pin must be connected to ground through a  $20\text{-}\Omega$  resistor in order to avoid possible oscillations of the output stage. In the MSOP-10 package, this pin is internally connected and does not require such precaution. An X2Y<sup>®</sup> capacitor has been used for power-supply bypassing. The combination of low inductance, high resonance frequency, and integration of three capacitors in one package (two capacitors to ground and one across the supplies) of this capacitor enables to achieve the low second-harmonic distortion reported in *Electrical Characteristics:  $V_S = \pm 5\text{ V}$* .

More information on how the VCA822 device operates can be found in the *Operating Suggestions* section.

**10.2.1.3 Application Curve**

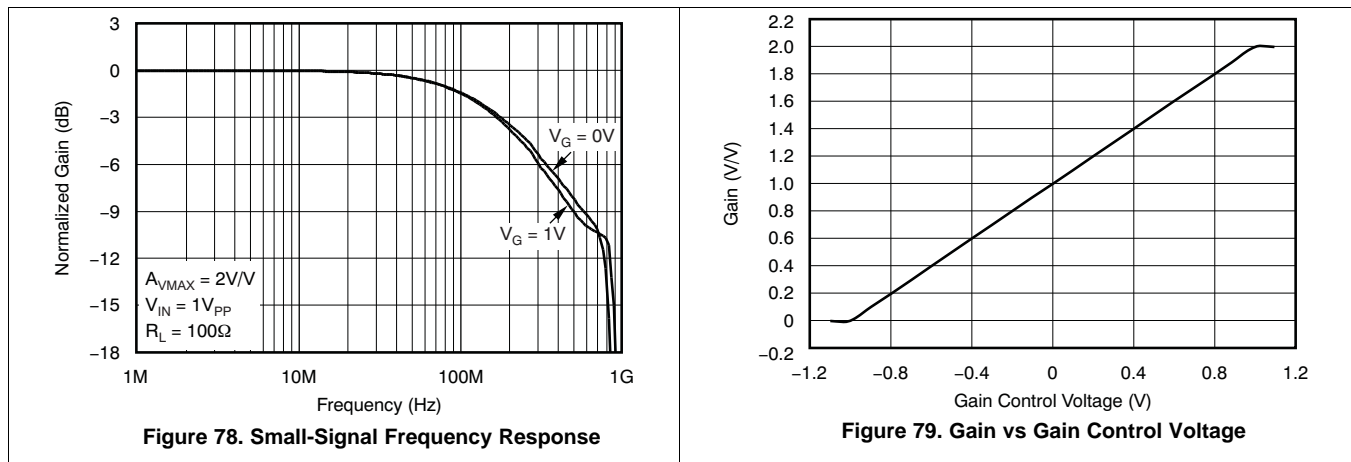

**10.2.2 Four-Quadrant Multiplier Application**

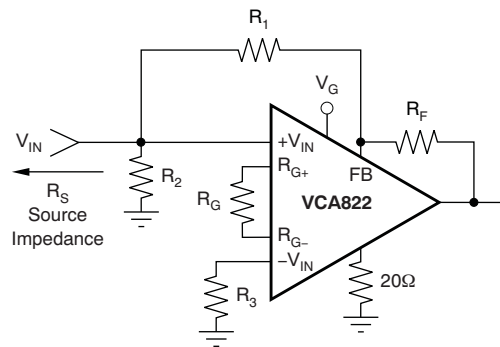

**Figure 80. Four-Quadrant Multiplier Circuit**

**10.2.2.1 Design Requirements**

A multiplier requires two inputs, one for the X input and one for the Y input. The output of the multiplier circuit is in the form of  $V_{OUT} = aV_{in1} \times bV_{in2}$ : where a and b are real numbers and should not be negative. For four quadrant operation both positive and negative inputs must be supported on the X and Y inputs.

**10.2.2.2 Detailed Design Procedure**

A four-quadrant multiplier can easily be implemented using the VCA822. By placing a resistor between FB and  $V_{IN}$ , the transfer function depends upon both  $V_{IN}$  and  $V_G$ , as shown in Equation 5.

$$V_{OUT} = \frac{R_F}{R_G} \times V_G \times V_{IN} + \left( \frac{R_F}{R_G} - \frac{R_F}{R_1} \right) \times V_{IN} \quad (5)$$

Setting  $R_1$  to equal  $R_G$ , the term that depends only on  $V_{IN}$  drops out of the equation, leaving only the term that depends on both  $V_G$  and  $V_{IN}$ .  $V_{OUT}$  then follows Equation 6.

$$V_{OUT} = \frac{R_F}{R_G} \times V_{IN} \times V_G \quad (6)$$

The behavior of this circuit is illustrated in Figure 81. Keeping the input amplitude of a 1MHz signal constant and varying the  $V_G$  voltage (100kHz, 2V<sub>PP</sub>) gives the modulated output voltage shown in Figure 81.

### 10.2.2.3 Application Curves

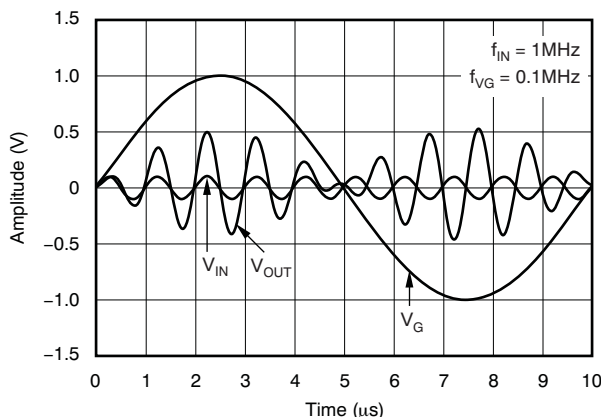

Figure 81. Modulated Output Signal of the Four-Quadrant Multiplexer Circuit

### 10.2.3 Difference Amplifier Application

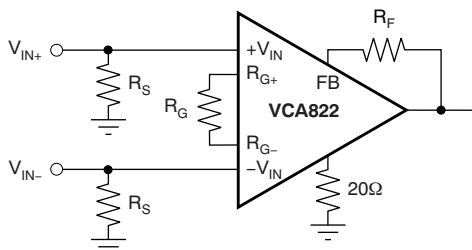

Figure 82. Difference Amplifier

#### 10.2.3.1 Design Requirements

For a difference amplifier, the design requirements are differential voltage gain, common mode rejection, and load drive capability. This circuit delivers differential gain of  $2 \times (R_f/R_g)$ , and CMRR as shown in Figure 83.

#### 10.2.3.2 Detailed Design Procedure

Because both inputs of the VCA822 device are high-impedance, a difference amplifier can be implemented without any major problem. This implementation is shown in Figure 82. This circuit provides excellent common-mode rejection ratio (CMRR) as long as the input is within the CMRR range of  $-2.1$  V to  $+1.6$  V. Note that this circuit does not make use of the gain control pin,  $V_G$ . Also, it is recommended to choose  $R_S$  such that the pole formed by  $R_S$  and the parasitic input capacitance does not limit the bandwidth of the circuit. The common-mode rejection ratio for this circuit implemented in a gain of  $+10$  V/V for  $V_G = +1$  V is shown in Figure 83. Note that because the gain control voltage is fixed and is normally set to  $+1$  V, the feedback element can be reduced in order to increase the bandwidth. When reducing the feedback element make sure that the VCA822 device is not limited by common-mode input voltage, the current flowing through  $R_G$ , or any other limitation described in this data sheet.

### 10.2.3.3 Application Curve

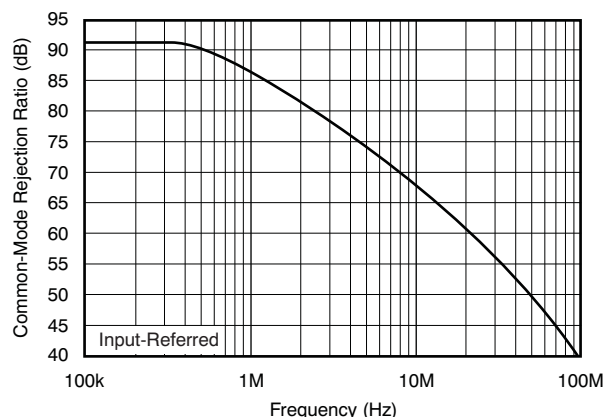

**Figure 83. Common-Mode Rejection Ratio**

### 10.2.4 Differential Equalizer Application

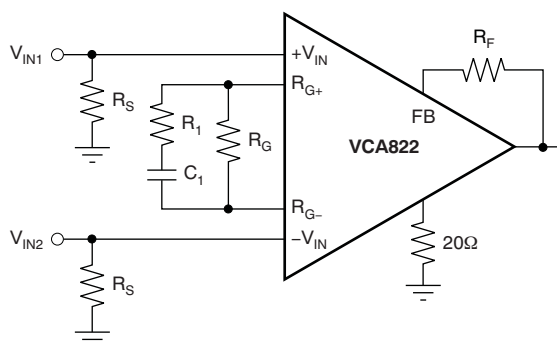

**Figure 84. Differential Equalizer**

#### 10.2.4.1 Design Requirements

Signals that travel over a length of cable experience an attenuation that is proportional to the square root of the frequency. For this reason, a fixed bandwidth amplifier will not restore the original signal. To replicate the original signal, the higher frequency signal components require more gain. The circuit in [Figure 84](#) has one stage of frequency shaping to help restore a signal transmitted along a cable. If needed, additional frequency shaping stages can be added as shown in [Figure 85](#).

#### 10.2.4.2 Detailed Design Procedure

If the application requires frequency shaping (the transition from one gain to another), the VCA822 device can be used advantageously because its architecture allows the application to isolate the input from the gain setting elements. [Figure 84](#) shows an implementation of such a configuration. The transfer function is shown in [Equation 7](#).

$$G = 2 \times \frac{R_F}{R_G} \times \frac{1 + sR_G C_1}{1 + sR_1 C_1} \quad (7)$$

This transfer function has one pole,  $P_1$  (located at  $R_G C_1$ ), and one zero,  $Z_1$  (located at  $R_1 C_1$ ). When equalizing an RC load,  $R_L$  and  $C_L$ , compensate the pole added by the load located at  $R_L C_L$  with the zero  $Z_1$ . Knowing  $R_L$ ,  $C_L$ , and  $R_G$  allows the user to select  $C_1$  as a first step and then calculate  $R_1$ . Using  $R_L = 75 \Omega$ ,  $C_L = 100 \text{ pF}$  and wanting the VCA822 device to operate at a gain of  $+2V/V$ , which gives  $R_F = R_G = 1.33 \text{ k}\Omega$ , allows the user to select  $C_1 = 5 \text{ pF}$  to ensure a positive value for the resistor  $R_1$ . With all these values known,  $R_1$  can be calculated to be  $170 \Omega$ . The frequency response for both the initial, unequalized frequency response and the resulting equalized frequency response are shown in [Figure 85](#).

### 10.2.4.3 Application Curve

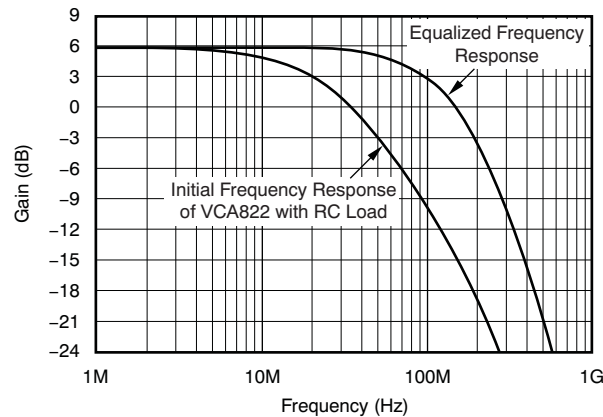

Figure 85. Differential Equalization of an RC Load

### 10.2.5 Differential Cable Equalizer Application

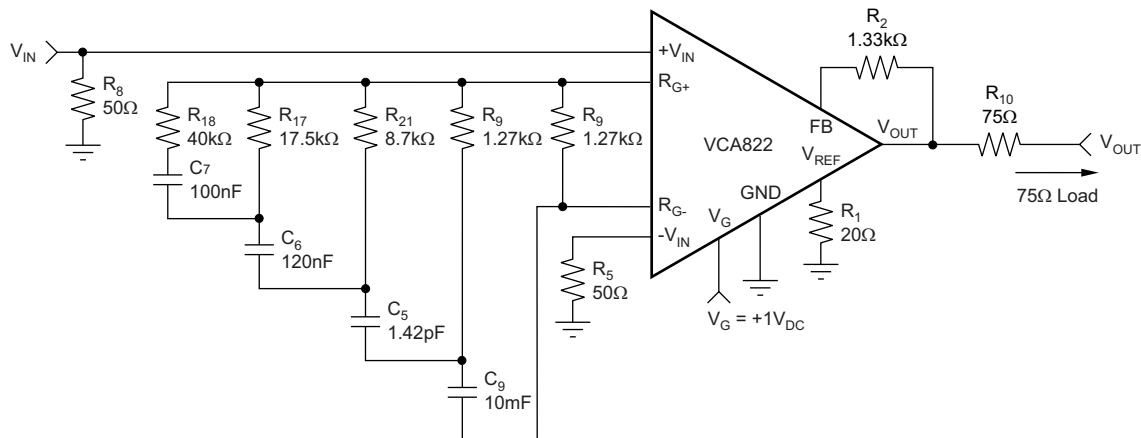

Figure 86. Differential Cable Equalizer

#### 10.2.5.1 Design Requirements

Signals that travel over a length of cable experience an attenuation that is proportional to the square root of the frequency. For this reason, a fixed bandwidth amplifier will not restore the original signal. To replicate the original signal, the higher frequency signal components require more gain. The circuit in Figure 86 has multiple stages of frequency shaping to help restore a signal transmitted along a cable. This circuit is similar to the one shown in Figure 84, but is much more accurate in replicating the  $1/\sqrt{f}$  frequency response shape.

#### 10.2.5.2 Detailed Design Procedure

A differential cable equalizer can easily be implemented using the VCA822. An example of a cable equalization for 100 feet of Belden Cable 1694F is illustrated in Figure 86, with the result for this implementation shown in Figure 87. This implementation has a maximum error of 0.2dB from dc to 40MHz.

### 10.2.5.3 Application Curve

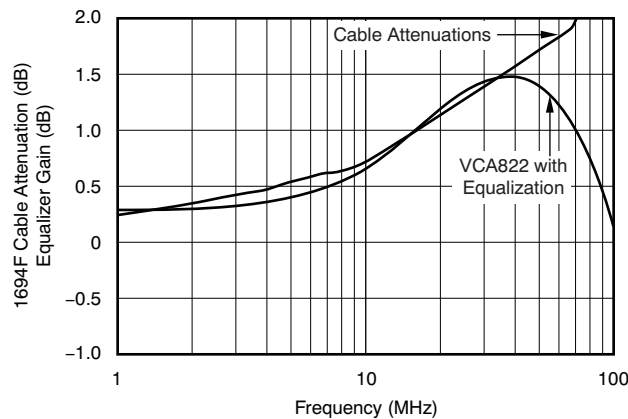

Figure 87. Cable Attenuation versus Equalizer Gain

#### NOTE

This implementation shows the cable attenuation side-by-side with the equalization in the same plot. For a given frequency, the equalization function realized with the VCA822 device matches the cable attenuation. The circuit in Figure 86 is a driver circuit. To implement a receiver circuit, the signal is received differentially between the  $+V_{IN}$  and  $-V_{IN}$  inputs.

### 10.2.6 Voltage-Controlled Low-Pass Filter Application

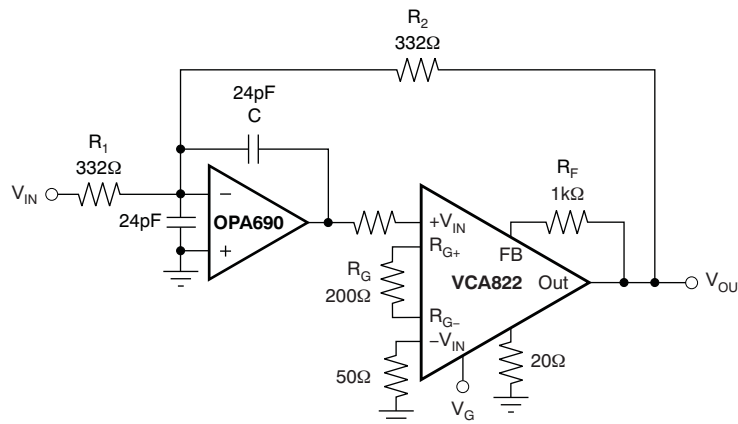

Figure 88. Voltage-Control Low-Pass Filter

#### 10.2.6.1 Design Requirements

A low pass filter should be DC coupled and should only pass frequencies up to the cut off frequency. A good filter provides increasing attenuation as the frequency increases above the cutoff frequency as well as a flat frequency response over the range of frequencies below the cutoff frequency. Passive filters have the limitation of a fixed cutoff frequency unless variable capacitors or inductors are used. This circuit uses the variable gain of the VCA822 to provide an electronically controlled cutoff frequency.

#### 10.2.6.2 Detailed Design Procedure

In the circuit of Figure 88, the VCA822 device serves as the variable-gain element of a voltage-controlled low-pass filter. This section discusses how this implementation expands the circuit voltage swing capability over that normally achieved with the equivalent multiplier implementation. The circuit control voltage,  $V_G$ , is calculated as according to the simplified relationship in Equation 8:



$$\frac{V_{OUT}}{V_{IN}} = -\frac{R_2}{R_1} \times \frac{1}{1 + s \frac{R_2 C}{G}} \quad (8)$$

The response control results from amplification of the feedback voltage applied to  $R_2$ . First, consider the case where the VCA822 device produces  $G = 1V/V$ . Then this circuit performs as if the amplifier were replaced by a short circuit. Visually replacing the amplifier by a short leaves a simple voltage-feedback amplifier with a feedback resistor bypassed by a capacitor. Replacing this gain with a variable gain,  $G$ , the pole can be written as shown in Equation 9:

$$f_b = \frac{G}{2\pi R_2 C} \quad (9)$$

Because the VCA822 device is most linear in the midrange, the median of the adjustable pole should be set at  $V_G = 0V$  (see Figure 79, Figure 42, Figure 63, and Equation 10). Selecting  $R_1 = R_2 = 332 \Omega$ , and targeting a median frequency of 10 MHz, the capacitance ( $C$ ) is 24 pF. Because the OPA690 was selected for the circuit of Figure 88, and in order to limit peaking in the OPA690 frequency response, a capacitor equal to  $C$  was added on the inverting mode to ground. This architecture has the effect of setting the high-frequency noise gain of the OPA690 to +2 V/V, ensuring stability and providing flat frequency response.

$$-0.8V \leq V_G \leq 0.8V \quad (10)$$

Once the median frequency is set, the maximum and minimum frequencies can be determined by using  $V_G = -0.8V$  and  $V_G = +0.8V$  in the gain equation of Equation 11. Note that this is a first-order analysis and does not take into consideration the open-loop gain limitation of the OPA690.

$$G = 2 \times \frac{R_F}{R_G} \times \frac{V_G + 1}{2} \quad (11)$$

With the components shown, the circuit provides a linear variation of the low-pass cutoff from 2MHz to 20MHz, using  $-1V \leq V_G \leq +1V$ . Practical evaluation shows that this circuit works from 8 MHz to 16 MHz with  $-0.8V < V_G < +0.8V$ , as shown in Figure 89.

### 10.2.6.3 Application Curve

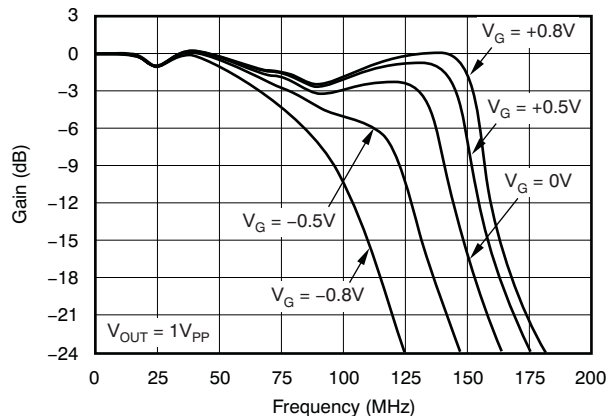

Figure 89. VCA822 as a Voltage-Control, Low-Pass Filter

### 10.3 System Examples

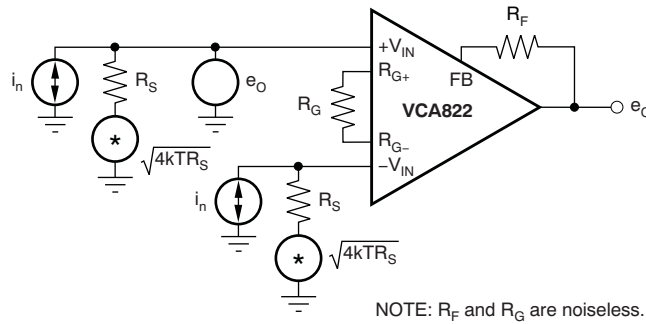

Figure 90. Simple Noise Model

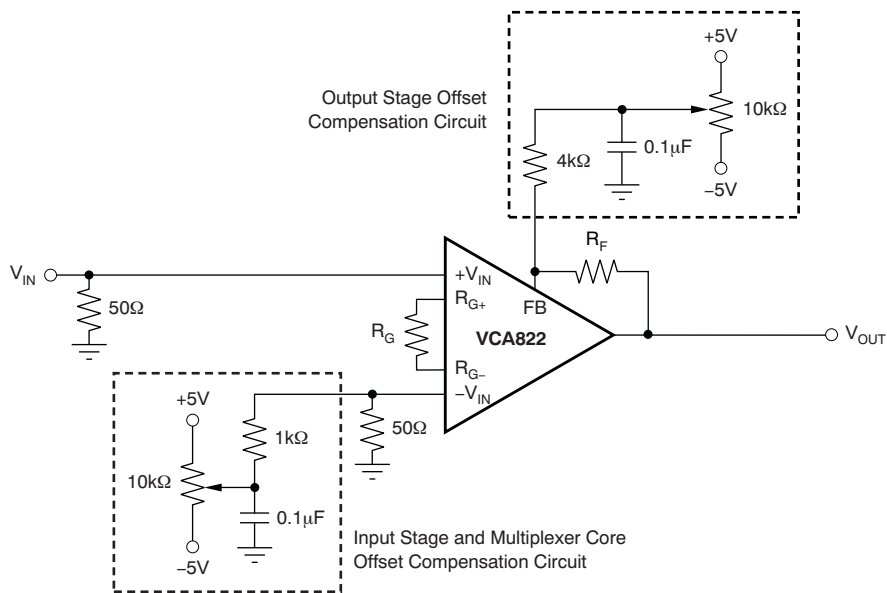

Figure 91. Adjusting the Input and Output Voltage Sources

System Examples (continued)

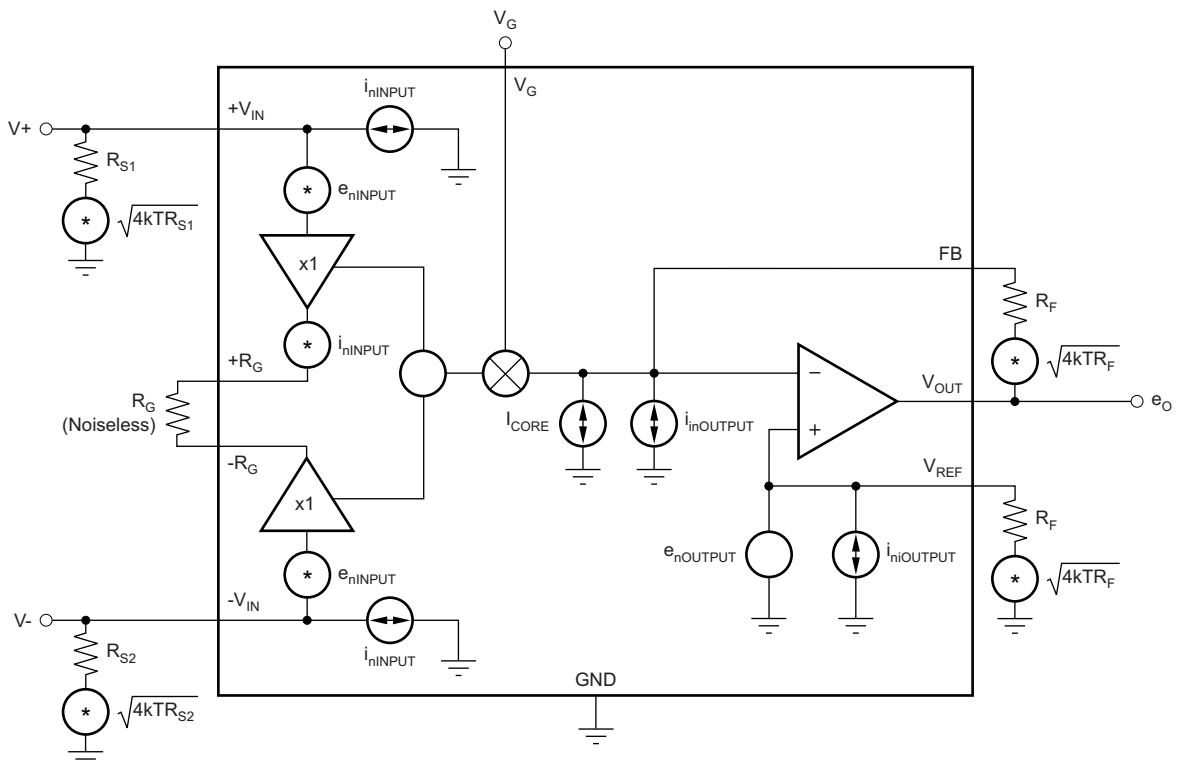

Figure 92. Full Noise Model

## 11 Power Supply Recommendations

High-speed amplifiers require low inductance power supply traces and low ESR bypass capacitors. The power supply voltage should be centered on the desired amplifier output voltage, so for ground referenced output signals, split supplies are required. The power supply voltage should be from 7 V to 12 V.

## 12 Layout

### 12.1 Layout Guidelines

Achieving optimum performance with a high-frequency amplifier such as the VCA822 device requires careful attention to printed circuit board (PCB) layout parasitics and external component types. Recommendations to optimize performance include:

- a. **Minimize parasitic capacitance** to any AC ground for all of the signal I/O pins. This recommendation includes the ground pin (pin 2). Parasitic capacitance on the output can cause instability: on both the inverting input and the noninverting input, it can react with the source impedance to cause unintentional band limiting. To reduce unwanted capacitance, a window around the signal I/O pins should be opened in all of the ground and power planes around those pins. Otherwise, ground and power planes should be unbroken elsewhere on the board. Place a small series resistance (greater than 25  $\Omega$ ) with the input pin connected to ground to help decouple package parasitics.
- b. **Minimize the distance** (less than 0.25") from the power-supply pins to high-frequency 0.1- $\mu$ F decoupling capacitors. At the device pins, the ground and power plane layout should not be in close proximity to the signal I/O pins. Avoid narrow power and ground traces to minimize inductance between the pins and the decoupling capacitors. The power-supply connections should always be decoupled with these capacitors. Larger (2.2- $\mu$ F to 6.8- $\mu$ F) decoupling capacitors, effective at lower frequencies, should also be used on the main supply pins. These capacitors may be placed somewhat farther from the device and may be shared among several devices in the same area of the PCB.
- c. **Careful selection and placement** of external components preserve the high-frequency performance of the VCA822. Resistors should be a very low reactance type. Surface-mount resistors work best and allow a tighter overall layout. Metal-film and carbon composition, axially-leaded resistors can also provide good high-frequency performance. Again, keep the leads and PCB trace length as short as possible. Never use wire-wound type resistors in a high-frequency application. Because the output pin is the most sensitive to parasitic capacitance, always position the series output resistor, if any, as close as possible to the output pin. Other network components, such as inverting or non-inverting input termination resistors, should also be placed close to the package.
- d. **Connections to other wideband devices** on the board may be made with short direct traces or through onboard transmission lines. For short connections, consider the trace and the input to the next device as a lumped capacitive load. Relatively wide traces (50 mils to 100 mils, or 1.27 mm to 2.54 mm) should be used, preferably with ground and power planes opened up around them.
- e. **Socketing a high-speed part like the VCA822 device is not recommended.** The additional lead length and pin-to-pin capacitance introduced by the socket can create an extremely troublesome parasitic network, which can make it almost impossible to achieve a smooth, stable frequency response. Best results are obtained by soldering the VCA822 device onto the board.

## 12.2 Layout Example

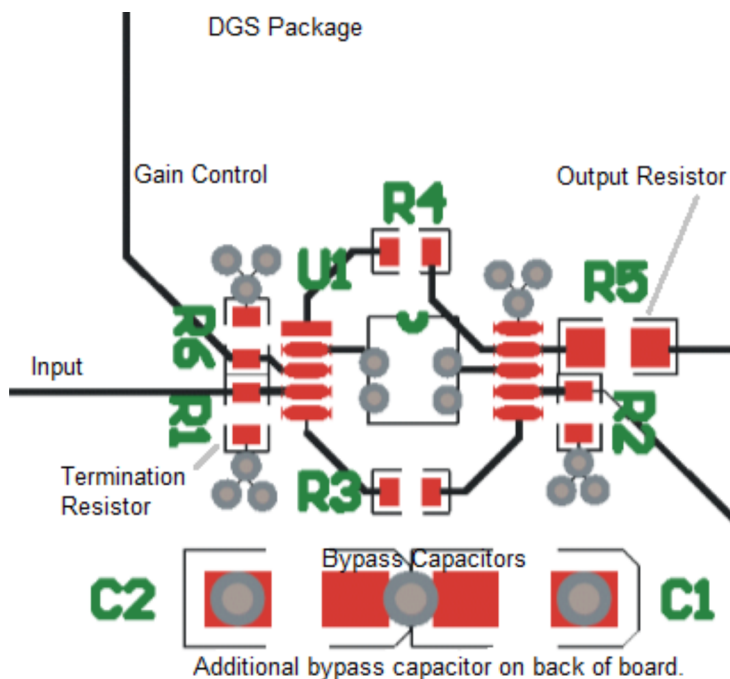

Figure 93. Layout Recommendation

## 12.3 Thermal Considerations

The VCA822 device does not require heat-sinking or airflow in most applications. The maximum desired junction temperature sets the maximum allowed internal power dissipation as described in this section. In no case should the maximum junction temperature be allowed to exceed +150°C.

Operating junction temperature ( $T_J$ ) is given by Equation 12.

$$T_J = T_A + P_D \times \theta_{JA} \quad (12)$$

The total internal power dissipation ( $P_D$ ) is the sum of quiescent power ( $P_{DQ}$ ) and additional power dissipated in the output stage ( $P_{DL}$ ) to deliver load power. Quiescent power is simply the specified no-load supply current times the total supply voltage across the part.  $P_{DL}$  depends on the required output signal and load; for a grounded resistive load, however, it is at a maximum when the output is fixed at a voltage equal to one-half of either supply voltage (for equal bipolar supplies). Under this worst-case condition,  $P_{DL} = V_S^2 / (4 \times R_L)$ , where  $R_L$  is the resistive load.

Note that it is the power in the output stage and not in the load that determines internal power dissipation. As a worst-case example, compute the maximum  $T_J$  using a VCA822ID (SOIC-14 package) in the circuit of Figure 77 operating at maximum gain and at the maximum specified ambient temperature of +85°C.

$$P_D = 10V(38mA) + 5^2 / (4 \times 100\Omega) = 442.5mW \quad (13)$$

$$\text{Maximum } T_J = +85^\circ\text{C} + (0.449W \times 80^\circ\text{C/W}) = 120.5^\circ\text{C} \quad (14)$$

This maximum operating junction temperature is well below most system level targets. Most applications should be lower because an absolute worst-case output stage power was assumed in this calculation of  $V_{CC} / 2$ , which is beyond the output voltage range for the VCA822 device.

## 13 Device and Documentation Support

### 13.1 Device Support

#### 13.1.1 Third-Party Products Disclaimer

TI'S PUBLICATION OF INFORMATION REGARDING THIRD-PARTY PRODUCTS OR SERVICES DOES NOT CONSTITUTE AN ENDORSEMENT REGARDING THE SUITABILITY OF SUCH PRODUCTS OR SERVICES OR A WARRANTY, REPRESENTATION OR ENDORSEMENT OF SUCH PRODUCTS OR SERVICES, EITHER ALONE OR IN COMBINATION WITH ANY TI PRODUCT OR SERVICE.

### 13.2 Community Resources

The following links connect to TI community resources. Linked contents are provided "AS IS" by the respective contributors. They do not constitute TI specifications and do not necessarily reflect TI's views; see TI's [Terms of Use](#).

**TI E2E™ Online Community** *TI's Engineer-to-Engineer (E2E) Community*. Created to foster collaboration among engineers. At [e2e.ti.com](http://e2e.ti.com), you can ask questions, share knowledge, explore ideas and help solve problems with fellow engineers.

**Design Support** *TI's Design Support* Quickly find helpful E2E forums along with design support tools and contact information for technical support.

### 13.3 Trademarks

E2E is a trademark of Texas Instruments.

X2Y is a registered trademark of X2Y ATTENUATORS, LLC .

All other trademarks are the property of their respective owners.

### 13.4 Electrostatic Discharge Caution



These devices have limited built-in ESD protection. The leads should be shorted together or the device placed in conductive foam during storage or handling to prevent electrostatic damage to the MOS gates.

### 13.5 Glossary

[SLYZ022](#) — *TI Glossary*.

This glossary lists and explains terms, acronyms, and definitions.

## 14 Mechanical, Packaging, and Orderable Information

The following pages include mechanical, packaging, and orderable information. This information is the most current data available for the designated devices. This data is subject to change without notice and revision of this document. For browser-based versions of this data sheet, refer to the left-hand navigation.

**PACKAGING INFORMATION**

Orderable Device	Status (1)	Package Type	Package Drawing	Pins	Package Qty	Eco Plan (2)	Lead finish/ Ball material (6)	MSL Peak Temp (3)	Op Temp (°C)	Device Marking (4/5)	Samples
VCA822ID	ACTIVE	SOIC	D	14	50	RoHS & Green	NIPDAU	Level-2-260C-1 YEAR	-40 to 85	VCA822ID	<a href="#">Samples</a>
VCA822IDGST	ACTIVE	VSSOP	DGS	10	250	RoHS & Green	NIPDAUAG	Level-2-260C-1 YEAR	-40 to 85	BOS	<a href="#">Samples</a>
VCA822IDR	ACTIVE	SOIC	D	14	2500	RoHS & Green	NIPDAU	Level-2-260C-1 YEAR	-40 to 85	VCA822ID	<a href="#">Samples</a>
VCA822IDRG4	LIFEBUY	SOIC	D	14	2500	RoHS & Green	NIPDAU	Level-2-260C-1 YEAR	-40 to 85	VCA822ID	

(1) The marketing status values are defined as follows:

**ACTIVE:** Product device recommended for new designs.

**LIFEBUY:** TI has announced that the device will be discontinued, and a lifetime-buy period is in effect.

**NRND:** Not recommended for new designs. Device is in production to support existing customers, but TI does not recommend using this part in a new design.

**PREVIEW:** Device has been announced but is not in production. Samples may or may not be available.

**OBSELETE:** TI has discontinued the production of the device.

(2) **RoHS:** TI defines "RoHS" to mean semiconductor products that are compliant with the current EU RoHS requirements for all 10 RoHS substances, including the requirement that RoHS substance do not exceed 0.1% by weight in homogeneous materials. Where designed to be soldered at high temperatures, "RoHS" products are suitable for use in specified lead-free processes. TI may reference these types of products as "Pb-Free".

**RoHS Exempt:** TI defines "RoHS Exempt" to mean products that contain lead but are compliant with EU RoHS pursuant to a specific EU RoHS exemption.

**Green:** TI defines "Green" to mean the content of Chlorine (Cl) and Bromine (Br) based flame retardants meet JS709B low halogen requirements of <=1000ppm threshold. Antimony trioxide based flame retardants must also meet the <=1000ppm threshold requirement.

(3) MSL, Peak Temp. - The Moisture Sensitivity Level rating according to the JEDEC industry standard classifications, and peak solder temperature.

(4) There may be additional marking, which relates to the logo, the lot trace code information, or the environmental category on the device.

(5) Multiple Device Markings will be inside parentheses. Only one Device Marking contained in parentheses and separated by a "~" will appear on a device. If a line is indented then it is a continuation of the previous line and the two combined represent the entire Device Marking for that device.

(6) Lead finish/Ball material - Orderable Devices may have multiple material finish options. Finish options are separated by a vertical ruled line. Lead finish/Ball material values may wrap to two lines if the finish value exceeds the maximum column width.

**Important Information and Disclaimer:**The information provided on this page represents TI's knowledge and belief as of the date that it is provided. TI bases its knowledge and belief on information provided by third parties, and makes no representation or warranty as to the accuracy of such information. Efforts are underway to better integrate information from third parties. TI has taken and continues to take reasonable steps to provide representative and accurate information but may not have conducted destructive testing or chemical analysis on incoming materials and chemicals. TI and TI suppliers consider certain information to be proprietary, and thus CAS numbers and other limited information may not be available for release.

In no event shall TI's liability arising out of such information exceed the total purchase price of the TI part(s) at issue in this document sold by TI to Customer on an annual basis.



**TAPE AND REEL INFORMATION**

**QUADRANT ASSIGNMENTS FOR PIN 1 ORIENTATION IN TAPE**

\*All dimensions are nominal

Device	Package Type	Package Drawing	Pins	SPQ	Reel Diameter (mm)	Reel Width W1 (mm)	A0 (mm)	B0 (mm)	K0 (mm)	P1 (mm)	W (mm)	Pin1 Quadrant
VCA822IDGST	VSSOP	DGS	10	250	180.0	12.4	5.3	3.4	1.4	8.0	12.0	Q1
VCA822IDR	SOIC	D	14	2500	330.0	16.4	6.5	9.0	2.1	8.0	16.0	Q1

**TAPE AND REEL BOX DIMENSIONS**

\*All dimensions are nominal

Device	Package Type	Package Drawing	Pins	SPQ	Length (mm)	Width (mm)	Height (mm)
VCA822IDGST	VSSOP	DGS	10	250	210.0	185.0	35.0
VCA822IDR	SOIC	D	14	2500	356.0	356.0	35.0

**TUBE**

\*All dimensions are nominal

Device	Package Name	Package Type	Pins	SPQ	L (mm)	W (mm)	T (μm)	B (mm)
VCA822ID	D	SOIC	14	50	506.6	8	3940	4.32

# DGS0010A



# PACKAGE OUTLINE

## VSSOP - 1.1 mm max height

SMALL OUTLINE PACKAGE

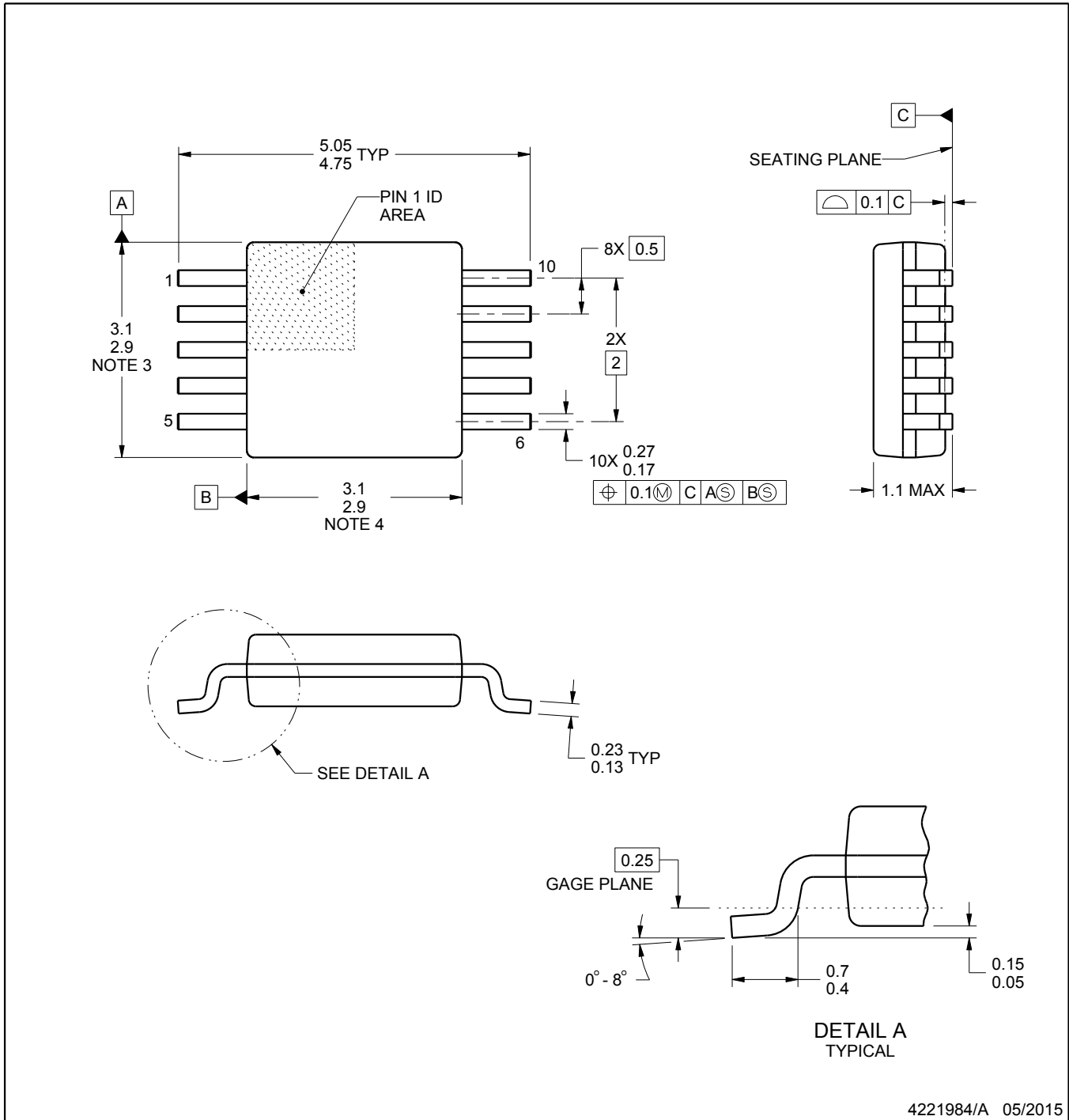

4221984/A 05/2015

### NOTES:

1. All linear dimensions are in millimeters. Any dimensions in parenthesis are for reference only. Dimensioning and tolerancing per ASME Y14.5M.
2. This drawing is subject to change without notice.
3. This dimension does not include mold flash, protrusions, or gate burrs. Mold flash, protrusions, or gate burrs shall not exceed 0.15 mm per side.
4. This dimension does not include interlead flash. Interlead flash shall not exceed 0.25 mm per side.
5. Reference JEDEC registration MO-187, variation BA.



# EXAMPLE STENCIL DESIGN

DGS0010A

VSSOP - 1.1 mm max height

SMALL OUTLINE PACKAGE



SOLDER PASTE EXAMPLE  
BASED ON 0.125 mm THICK STENCIL  
SCALE:10X

4221984/A 05/2015

NOTES: (continued)

8. Laser cutting apertures with trapezoidal walls and rounded corners may offer better paste release. IPC-7525 may have alternate design recommendations.
9. Board assembly site may have different recommendations for stencil design.

D (R-PDSO-G14)

PLASTIC SMALL OUTLINE



- NOTES:
- A. All linear dimensions are in inches (millimeters).
  - B. This drawing is subject to change without notice.
  -  Body length does not include mold flash, protrusions, or gate burrs. Mold flash, protrusions, or gate burrs shall not exceed 0.006 (0,15) each side.
  -  Body width does not include interlead flash. Interlead flash shall not exceed 0.017 (0,43) each side.
  - E. Reference JEDEC MS-012 variation AB.

D (R-PDSO-G14)

PLASTIC SMALL OUTLINE



4211283-3/E 08/12

- NOTES:
- All linear dimensions are in millimeters.
  - This drawing is subject to change without notice.
  - Publication IPC-7351 is recommended for alternate designs.
  - Laser cutting apertures with trapezoidal walls and also rounding corners will offer better paste release. Customers should contact their board assembly site for stencil design recommendations. Refer to IPC-7525 for other stencil recommendations.
  - Customers should contact their board fabrication site for solder mask tolerances between and around signal pads.



## IMPORTANT NOTICE AND DISCLAIMER

TI PROVIDES TECHNICAL AND RELIABILITY DATA (INCLUDING DATA SHEETS), DESIGN RESOURCES (INCLUDING REFERENCE DESIGNS), APPLICATION OR OTHER DESIGN ADVICE, WEB TOOLS, SAFETY INFORMATION, AND OTHER RESOURCES "AS IS" AND WITH ALL FAULTS, AND DISCLAIMS ALL WARRANTIES, EXPRESS AND IMPLIED, INCLUDING WITHOUT LIMITATION ANY IMPLIED WARRANTIES OF MERCHANTABILITY, FITNESS FOR A PARTICULAR PURPOSE OR NON-INFRINGEMENT OF THIRD PARTY INTELLECTUAL PROPERTY RIGHTS.

These resources are intended for skilled developers designing with TI products. You are solely responsible for (1) selecting the appropriate TI products for your application, (2) designing, validating and testing your application, and (3) ensuring your application meets applicable standards, and any other safety, security, regulatory or other requirements.

These resources are subject to change without notice. TI grants you permission to use these resources only for development of an application that uses the TI products described in the resource. Other reproduction and display of these resources is prohibited. No license is granted to any other TI intellectual property right or to any third party intellectual property right. TI disclaims responsibility for, and you will fully indemnify TI and its representatives against, any claims, damages, costs, losses, and liabilities arising out of your use of these resources.

TI's products are provided subject to [TI's Terms of Sale](#) or other applicable terms available either on [ti.com](https://www.ti.com) or provided in conjunction with such TI products. TI's provision of these resources does not expand or otherwise alter TI's applicable warranties or warranty disclaimers for TI products.

TI objects to and rejects any additional or different terms you may have proposed.

Mailing Address: Texas Instruments, Post Office Box 655303, Dallas, Texas 75265  
Copyright © 2023, Texas Instruments Incorporated