

## ADS54T01 单通道 12 位 750 Msps 接收器和反馈 IC

### 1 特性

- 单通道
- 12 位分辨率
- 最大时钟频率：750 Msps
- 低摆幅全刻度输入：1.0 Vpp
- 模拟输入缓冲器，具有高阻抗输入
- 输入带宽 (3dB)：> 1.2 GHz
- 数据输出接口：DDR LVDS
- 196 引脚 NFBGA 封装 (12mm × 12mm)
- 功耗：1.2W
- $f_{in} = 230$  MHz IF 时的性能
  - SNR：60.7 dBFS
  - SFDR：73 dBc
- $f_{in} = 700$  MHz IF 时的性能
  - SNR：58.6 dBFS
  - SFDR：64 dBc
- 接收模式：使用低通或高通滤波器进行 2 倍抽取
- 反馈模式：针对全带宽 DPD 反馈的突发模式输出

### 2 应用

- 电信
- 无线基础设施
- 功率放大器线性化

### 3 说明

ADS54T01 是一款高线性度单通道 12 位 750Msps 模数转换器 (ADC)，此器件简化了宽带接收器的前端滤波器设计。模拟输入缓冲器使片载跟踪和保持功能的内部切换不会干扰信号源并提供一个高阻抗输入。

有两个针对输出数据的输出模式：对数据进行二倍抽取；或者以突发模式输出数据。突发模式输出特别设计用于 DPD 反馈应用，在此类应用中，高分辨率输出数据在短时间内可用。此 ADC 设计用于高 SFDR，且在宽输入频率范围内具有低噪声性能以及出色的无杂散动态范围。此器件采用 196 引脚 NFBGA 封装并且可在整个工业温度范围 ( - 40°C 至 85°C ) 内正常工作。

#### 器件信息

器件型号	封装 <sup>(1)</sup>	封装尺寸 (标称值)
ADS54T01	NFBGA (196)	12.00mm x 12.00mm

(1) 如需了解所有可用封装，请参阅数据表末尾的可订购产品附录。

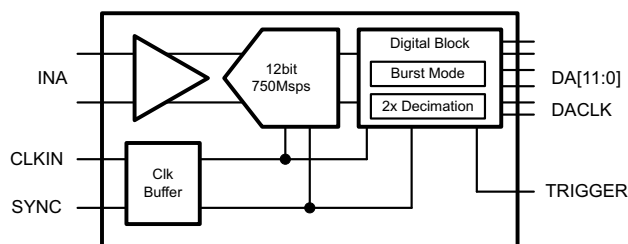

功能方框图



## Table of Contents

<b>1 特性</b> .....	<b>1</b>	<b>8 Detailed Description</b> .....	<b>22</b>
<b>2 应用</b> .....	<b>1</b>	8.1 Overview.....	22
<b>3 说明</b> .....	<b>1</b>	8.2 Functional Block Diagram.....	22
<b>4 Revision History</b> .....	<b>2</b>	8.3 Feature Description.....	22
<b>5 Device Comparison</b> .....	<b>3</b>	8.4 Device Functional Modes.....	29
<b>6 Pin Configuration and Functions</b> .....	<b>3</b>	8.5 Programming.....	32
<b>7 Specifications</b> .....	<b>6</b>	8.6 Register Maps.....	34
7.1 Absolute Maximum Ratings.....	6	<b>9 Power Supply Recommendations</b> .....	<b>39</b>
7.2 ESD Ratings.....	6	<b>10 Device and Documentation Support</b> .....	<b>40</b>
7.3 Recommended Operating Conditions.....	7	10.1 接收文档更新通知.....	40
7.4 Thermal Information.....	7	10.2 支持资源.....	40
7.5 Electrical Characteristics.....	7	10.3 Trademarks.....	40
7.6 Electrical Characteristics.....	9	10.4 Electrostatic Discharge Caution.....	40
7.7 Electrical Characteristics.....	10	10.5 术语表.....	40
7.8 Electrical Characteristics.....	11	<b>11 Mechanical, Packaging, and Orderable Information</b> .....	<b>40</b>
7.9 Electrical Characteristics.....	11		
7.10 Typical Characteristics.....	13		

## 4 Revision History

### Changes from Revision A (January 2014) to Revision B (April 2022) Page

• 添加了 ESD 等级表、特性说明部分、器件功能模式、应用和实施部分、电源相关建议部分、布局部分、器件和文档支持部分以及机械、封装和可订购信息部分.....	1
• 更新了整个文档中的表格、图和交叉参考的编号格式.....	1
• Changed Revision A History from "Deleted P7, N7" to "Deleted G4, G3".....	2
• Changed <i>Pin Functions</i> table to match TI Standards.....	3

### Changes from Revision \* (December 2012) to Revision A (January 2014) Page

• Deleted G4, G3 from TRDYP/N pin numbers.....	3
• Changed package from QFN to nFBGA in THERMAL INFORMATION.....	7
• Added text and figure to TEST PATTERN OUTPUT section.....	22
• Deleted text from last paragraph in INTERLEAVING CORRECTION section.....	26
• Changed second paragraph in MULTI DEVICE SYNCHRONIZATION section.....	28
• Deleted Register Initialization section and added Device Initialization section.....	32
• Changed Register Address 2 Bit D13 from 0 to 1 in SERIAL REGISTER MAP.....	34
• Changed Register Address E Bits D1 and D0 to 0 in SERIAL REGISTER MAP.....	34
• Changed Register Address 38 Bits D3 to D0 from 0 to 1 in SERIAL REGISTER MAP.....	34
• Changed Register Address 2 Bit D13 from 0 to 1 and add D13 Read back 1.....	34
• Changed Register Address E Bit D1 and D0 to 0.....	34
• Changed Register Address 38 Bits D3 to D0 from 0 to 1 and add D3 to D0 Read back 1.....	34
• Changed Register Address 66 D15-D10 to D15-D0 and D11-D10 to D11-D0.....	34

## 5 Device Comparison

表 5-1. Device Comparison

PART NUMBER	NUMBER OF CHANNELS	SPEED GRADE
ADS54T02	2	750 Msps
ADS54T01	1	750 Msps
ADS54T04	2	500 Msps

## 6 Pin Configuration and Functions

	A	B	C	D	E	F	G	H	J	K	L	M	N	P	
14	VREF	VCM	GND	NC	NC	GND	AVDDC	AVDDC	GND	INA_P	INA_N	GND	GND	CLKINP	14
13	SDENB	TEST MODE	GND	GND	GND	GND	GND	GND	GND	GND	GND	GND	GND	CLKINN	13
12	SCLK	SRESET	GND	AVDD33	AVDD33	AVDD33	AVDD33	AVDD33	AVDD33	AVDD33	AVDD33	GND	AVDD33	AVDD33	12
11	SDIO	ENABLE	GND	AVDD18	AVDD18	AVDD18	AVDD18	AVDD18	AVDD18	AVDD18	AVDD18	GND	AVDD18	AVDD18	11
10	SDO	IOVDD	GND	AVDD18	GND	GND	GND	GND	GND	GND	AVDD18	GND	TRIGGER N	TRIGGER P	10
9	DVDD	DVDD	GND	GND	GND	GND	GND	GND	GND	GND	GND	GND	SYNCP	SYNCP	9
8	DVDD	DVDD	DVDD	DVDD	GND	GND	GND	GND	GND	GND	DVDD	DVDD	DVDD	DVDD	8
7	NC	NC	DVDD LVDS	DVDD LVDS	GND	GND	GND	GND	GND	GND	DVDD LVDS	DVDD LVDS	TRDYN	TRDYP	7
6	NC	NC	DVDD LVDS	DVDD LVDS	GND	GND	GND	GND	GND	GND	DVDD LVDS	DVDD LVDS	HRESN	HRESP	6
5	NC	NC	NC	NC	GND	GND	GND	GND	GND	GND	OVRAN	OVRAP	SYNC OUTN	SYNC OUTP	5
4	NC	NC	NC	NC	NC	NC	NC	DA0P	DA2P	DA4P	DA6P	DA8P	NC	NC	4
3	NC	NC	NC	NC	NC	NC	NC	DA0N	DA2N	DA4N	DA6N	DA8N	DA11N	DA11P	3
2	NC	NC	NC	NC	NC	NC	NC	DACLKP	DA1P	DA3P	DA5P	DA7P	DA10N	DA10P	2
1	NC	NC	NC	NC	NC	NC	NC	DACLKN	DA1N	DA3N	DA5N	DA7N	DA9N	DA9P	1

图 6-1. ADS54T01 ZAY Package, 196-Pin NFBGA, Top View (DDR Output Mode)

表 6-1. Pin Functions

PIN		I/O TYPE <sup>(1)</sup>	DESCRIPTION
NAME	NUMBER		
<b>INPUT/REFERENCE</b>			
INA_P/N	K14, L14	I	Analog ADC differential input signal.
VCM	B14	O	Output of the analog input common mode (nominally 1.9 V). A 0.1- μ F capacitor to AGND is recommended, but not required.
VREF	A14	I	Reference voltage input. A 0.1- μ F capacitor to AGND is recommended.
<b>CLOCK/SYNC</b>			

表 6-1. Pin Functions (continued)

PIN		I/O TYPE <sup>(1)</sup>	DESCRIPTION
NAME	NUMBER		
CLKINP/N	P14, P13	I	Differential input clock
SYNCP/N	P9, N9	I	Synchronization input. Inactive if logic low. When clocked in a high state initially, this is used for resetting internal clocks and digital logic and starting the SYNCOUT signal. Internal 100-Ω termination.
<b>CONTROL/SERIAL</b>			
SRESET	B12	I	Serial interface reset input. Active low. Initialized internal registers during high-to-low transition. Asynchronous. Internal 50-kΩ pullup resistor to IOVDD.
ENABLE	B11	I	Chip enable - active high. Power-down function can be controlled through SPI register assignment. Internal 50-kΩ pullup resistor to IOVDD.
SCLK	A12	I	Serial interface clock. Internal 50-kΩ pulldown resistor.
SDIO	A11	I/O	Bidirectional serial data in 3-pin mode (default). In 4-pin interface mode (register x00, D16), the SDIO pin in an input only. Internal 50-kΩ pulldown resistor.
SDENB	A13	I	Serial interface enable. Internal 50-kΩ pulldown resistor.
SDO	A10	O	Uni-directional serial interface data in 4-pin mode (register x00, D16). The SDO pin is tri-stated in 3-pin interface mode (default). Internal 50-kΩ pulldown resistor.
<b>DATA INTERFACE</b>			
DA[11:0]P/N	P3, N3, P2, N2, P1, N1, M4, M3, M2, M1, L4, L3, L2, L1, K4, K3, K2, K1, J4, J3, J2, J1, H4, H3	O	ADC A Data Bits 11 (MSB) to 0 (LSB) in DDR output mode. Standard LVDS output.
DACLKP/N	H2, H1	O	DDR differential output data clock for Bus A. Register programmable to provide either rising or falling edge to center of stable data nominal timing.
SYNCOUTP/N	P5, N5	O	Synchronization output signal for synchronizing multiple ADCs. Can be disabled through the SPI.
OVRAP/N	M5, L5	O	Bus A, Overrange indicator, LVDS output. A logic high signals an analog input in excess of the full-scale range. Optional SYNC output.
TRIGGERP/N	P10, N10	I	Trigger used for high-resolution output data in feedback mode. Internal 100-Ω termination.
TRDYP/N	P7, N7	O	Trigger ready output indicator
HRESP/N	P6, N6	O	Indicator for high-resolution output data; logic high signals 12-bit output data.
<b>NO CONNECT</b>			
NC	A1, A2, A3, A4, A5, A6, A7, B1, B2, B3, B4, B5, B6, B7, C1, C2, C3, C4, C5, D1, D2, D3, D4, D5, D14, E1, E2, E3, E4, E14, F1, F2, F3, F4, G1, G2, G3, G4, N4, P4	-	Do not connect to pin, leave floating.
TESTMODE	B13	-	Used for factory internal test. Do not connect to pin, leave floating.
<b>POWER SUPPLY</b>			
AVDD33	D12, E12, F12, G12, H12, J12, K12, L12, N12, P12	P	3.3-V analog supply
AVDDC	G14, H14	P	1.8-V supply for clock input

**表 6-1. Pin Functions (continued)**

PIN		I/O TYPE <sup>(1)</sup>	DESCRIPTION
NAME	NUMBER		
AVDD18	D10, D11, E11, F11, G11, H11, J11, K11, L10, L11, N11, P11	P	1.8-V analog supply
DVDD	A8, A9, B8, B9, C8, D8, L8, M8, N8, P8	P	1.8-V supply for digital block
DVDDLVD5	C6, C7, D6, D7, L6, L7, M6, M7	P	1.8-V supply for LVDS outputs
IOVDD	B10	P	1.8-V for digital I/Os
GND	C9, C10, C11, C12, C13, C14, D9, D13, E5, E6, E7, E8, E9, E10, E13, F5, F6, F7, F8, F9, F10, F13, F14, G5, G6, G7, G8, G9, G10, H5, H6, H7, H8, H9, H10, J5, J6, J7, J8, J9, J10, K5, K6, K7, K8, K9, K10, L9, M9, M10, M11, M12, M13, M14, N13, N14	GND	Ground

(1) The definitions below define the I/O type for each pin.

- I = Input
- O = Output
- I/O = Input / Output
- P = Power Supply
- G = Ground

## 7 Specifications

### 7.1 Absolute Maximum Ratings

over operating free-air temperature range (unless otherwise noted) <sup>(1)</sup>

		MIN	MAX	UNIT
Supply voltage	AVDD33	- 0.5	4	V
	AVDDC	- 0.5	2.3	V
	AVDD18	- 0.5	2.3	V
	DVDD	- 0.5	2.3	V
	DVDDLVD5	- 0.5	2.3	V
	IOVDD	- 0.5	4	V
Voltage applied to input pins	INA_P, INA_N	- 0.5	AVDD33 + 0.5	V
	CLKINP, CLKINN	- 0.5	AVDDC + 0.5	V
	SYNCP, SYNCPN	- 0.5	AVDD33 + 0.5	V
	SRESET, SDENB, SCLK, SDIO, SDO, ENABLE	- 0.5	IOVDD + 0.5	V
Operating free-air temperature, T <sub>A</sub>		- 40	85	°C
Operating junction temperature, T <sub>J</sub>			150	°C
Storage temperature, T <sub>stg</sub>		- 65	150	°C

- (1) Operation outside the *Absolute Maximum Ratings* may cause permanent device damage. *Absolute Maximum Ratings* do not imply functional operation of the device at these or any other conditions beyond those listed under *Recommended Operating Conditions*. If used outside the *Recommended Operating Conditions* but within the *Absolute Maximum Ratings*, the device may not be fully functional, and this may affect device reliability, functionality, performance, and shorten the device lifetime.

### 7.2 ESD Ratings

			VALUE	UNIT
V <sub>(ESD)</sub>	Electrostatic discharge	Human-body model (HBM), per ANSI/ESDA/JEDEC JS-001, all pins <sup>(1)</sup>	±2000	V

- (1) JEDEC document JEP155 states that 500-V HBM allows safe manufacturing with a standard ESD control process.

## 7.3 Recommended Operating Conditions

over operating free-air temperature range (unless otherwise noted)

		MIN	NOM	MAX	UNIT
T <sub>J</sub>	Recommended operating junction temperature			105	°C
	Maximum rated operating junction temperature <sup>(1)</sup>	125			
T <sub>A</sub>	Recommended free-air temperature	- 40	25	85	°C

(1) Prolonged use at this junction temperature may increase the device failure-in-time (FIT) rate.

## 7.4 Thermal Information

THERMAL METRIC <sup>(1)</sup>		ADS54T01	UNIT
		ZAY (NFBGA)	
		196 PINS	
θ <sub>JA</sub>	Junction-to-ambient thermal resistance <sup>(2)</sup>	37.6	°C/W
θ <sub>JCtop</sub>	Junction-to-case (top) thermal resistance <sup>(3)</sup>	6.8	°C/W
θ <sub>JB</sub>	Junction-to-board thermal resistance <sup>(4)</sup>	16.8	°C/W
ψ <sub>JT</sub>	Junction-to-top characterization parameter <sup>(5)</sup>	0.2	°C/W
ψ <sub>JB</sub>	Junction-to-board characterization parameter <sup>(6)</sup>	16.4	°C/W

- For more information about traditional and new thermal metrics, see the [Semiconductor and IC Package Thermal Metrics](#) application report.
- The junction-to-ambient thermal resistance under natural convection is obtained in a simulation on a JEDEC-standard, high-K board, as specified in JESD51-7, in an environment described in JESD51-2a.
- The junction-to-case (top) thermal resistance is obtained by simulating a cold plate test on the package top. No specific JEDEC-standard test exists, but a close description can be found in the ANSI SEMI standard G30-88.
- The junction-to-board thermal resistance is obtained by simulating in an environment with a ring cold plate fixture to control the PCB temperature, as described in JESD51-8.
- The junction-to-top characterization parameter, ψ<sub>JT</sub>, estimates the junction temperature of a device in a real system and is extracted from the simulation data for obtaining R<sub>θJA</sub>, using a procedure described in JESD51-2a (sections 6 and 7).
- The junction-to-board characterization parameter, ψ<sub>JB</sub>, estimates the junction temperature of a device in a real system and is extracted from the simulation data for obtaining R<sub>θJA</sub>, using a procedure described in JESD51-2a (sections 6 and 7).

## 7.5 Electrical Characteristics

Typical values at T<sub>A</sub> = 25°C, full temperature range is T<sub>MIN</sub> = - 40°C to T<sub>MAX</sub> = 85°C, ADC sampling rate = 750 Msps, 50% clock duty cycle, AVDD33 = 3.3 V, AVDDC/AVDD18/DVDD/DVDDLVDVS/IOVDD = 1.8 V, - 1-dBFS differential input (unless otherwise noted).

PARAMETER	TEST CONDITIONS	MIN	TYP	MAX	UNITS
<b>ADC Clock Frequency</b>		40		750	MSPS
<b>Resolution</b>		12			Bits
<b>SUPPLY</b>					
AVDD33		3.15	3.3	3.45	V
AVDDC, AVDD18, DVDD, DVDDLVDVS		1.7	1.8	1.9	V
IOVDD		1.7	1.8	3.45	V
<b>POWER SUPPLY</b>					
I <sub>AVDD33</sub>	3.3-V Analog supply current		154	170	mA
I <sub>AVDD18</sub>	1.8-V Analog supply current		66	80	mA
I <sub>AVDDC</sub>	1.8-V Clock supply current		42	60	mA
I <sub>DVDD</sub>	1.8-V Digital supply current	Auto Correction Enabled	250	280	mA
I <sub>DVDD</sub>	1.8-V Digital supply current	Auto Correction Disabled	215		mA
I <sub>DVDD</sub>	1.8-V Digital supply current	Auto Correction Disabled, decimation filter enabled	234		mA
I <sub>DVDDLVDVS</sub>	1.8-V LVDS supply current		66	90	mA
I <sub>IOVDD</sub>	1.8-V I/O Voltage supply current		1	2	mA

## 7.5 Electrical Characteristics (continued)

Typical values at  $T_A = 25^\circ\text{C}$ , full temperature range is  $T_{\text{MIN}} = -40^\circ\text{C}$  to  $T_{\text{MAX}} = 85^\circ\text{C}$ , ADC sampling rate = 750 Msps, 50% clock duty cycle, AVDD33 = 3.3 V, AVDDC/AVDD18/DVDD/DVDDLVD/IOVDD = 1.8 V, -1-dBFS differential input (unless otherwise noted).

PARAMETER		TEST CONDITIONS	MIN	TYP	MAX	UNITS
$P_{\text{dis}}$	Total power dissipation	Auto Correction Enabled, decimation filter disabled		1.28	1.75	W
$P_{\text{dis}}$	Total power dissipation	Auto Correction Disabled, decimation filter disabled		1.2		W
PSRR		250 kHz to 500 MHz	40			dB
Shutdown power dissipation				7		mW
Shutdown wake-up time				2.5		ms
Standby power dissipation				7		mW
Standby wake-up time				100		$\mu\text{s}$
Deep-sleep mode power dissipation		Auto correction disabled		350		mW
		Auto correction enabled		475		mW
Deep-sleep mode wake-up time				20		$\mu\text{s}$
Light-sleep mode power dissipation		Auto correction disabled		655		mW
		Auto correction enabled		780		mW
Light-sleep mode wake-up time				2		$\mu\text{s}$



## 7.6 Electrical Characteristics

Typical values at  $T_A = 25^\circ\text{C}$ , full temperature range is  $T_{\text{MIN}} = -40^\circ\text{C}$  to  $T_{\text{MAX}} = 85^\circ\text{C}$ , ADC sampling rate = 750 Msps, 50% clock duty cycle, AVDD3V = 3.3 V, AVDD/DRVDD/IOVDD = 1.8 V, -1-dBFS differential input (unless otherwise noted).

PARAMETER	TEST CONDITIONS	MIN	TYP	MAX	UNITS
<b>ANALOG INPUTS</b>					
Differential input full-scale			1.0 1.25		V <sub>pp</sub>
Input common-mode voltage			1.9 ±0.1		V
Input resistance	Differential at DC		1		kΩ
Input capacitance	Each input to GND		2		pF
VCM common-mode voltage output			1.9		V
Analog input bandwidth (3 dB)			1200		MHz
<b>DYNAMIC ACCURACY</b>					
Offset Error	Auto Correction Disabled	- 20	- 7.5	20	mV
	Auto Correction Enabled	- 1	0	1	mV
Offset temperature coefficient			- 6.5		μV/°C
Gain error		- 5		5	%FS
Gain temperature coefficient			0.005		%FS/°C
Differential nonlinearity	$f_{\text{IN}} = 230 \text{ MHz}$	- 1	±0.9	2	LSB
Integral nonlinearity	$f_{\text{IN}} = 230 \text{ MHz}$	- 5	±1.5	5	LSB
<b>CLOCK INPUT</b>					
Input clock frequency		40		750	MHz
Input clock amplitude			2		V <sub>pp</sub>
Input clock duty cycle		40%	50%	60%	
Internal clock biasing			0.9		V

## 7.7 Electrical Characteristics

Typical values at  $T_A = 25^\circ\text{C}$ , full temperature range is  $T_{\text{MIN}} = -40^\circ\text{C}$  to  $T_{\text{MAX}} = 85^\circ\text{C}$ , ADC sampling rate = 750 Msps, 50% clock duty cycle, AVDD33 = 3.3 V, AVDDC/AVDD18/DVDD/DVDDLVDs/IOVDD = 1.8 V, -1-dBFS differential input (unless otherwise noted).

PARAMETER		TEST CONDITIONS	MIN	TYP	MAX	MIN	TYP	MAX	UNITS
Auto Correction			Enabled			Disabled			Vpp
<b>DYNAMIC AC CHARACTERISTICS<sup>(1)</sup> - Burst Mode Enabled: 12-bit High Resolution Output Data</b>									
SNR	Signal to Noise Ratio	$f_{\text{IN}} = 10\text{ MHz}$		61.1			61.2		dBFS
		$f_{\text{IN}} = 100\text{ MHz}$		61.1			61.1		
		$f_{\text{IN}} = 230\text{ MHz}$	59	60.7			60.9		
		$f_{\text{IN}} = 450\text{ MHz}$		59.9			60.5		
		$f_{\text{IN}} = 700\text{ MHz}$		58.6			59.6		
HD2,3	Second and third harmonic distortion	$f_{\text{IN}} = 10\text{ MHz}$		81			83		dBc
		$f_{\text{IN}} = 100\text{ MHz}$		76			81		
		$f_{\text{IN}} = 230\text{ MHz}$		78			79		
		$f_{\text{IN}} = 450\text{ MHz}$		75			76		
		$f_{\text{IN}} = 700\text{ MHz}$		74			76		
Non HD2,3	Spur Free Dynamic Range (excluding second and third harmonic distortion)	$f_{\text{IN}} = 10\text{ MHz}$		78			79		dBc
		$f_{\text{IN}} = 100\text{ MHz}$	68	75			77		
		$f_{\text{IN}} = 230\text{ MHz}$		73			73		
		$f_{\text{IN}} = 450\text{ MHz}$		68			69		
		$f_{\text{IN}} = 700\text{ MHz}$		64			66		
IL	Fs/2-Fin interleaving spur	$f_{\text{IN}} = 10\text{ MHz}$		90			87		dBc
		$f_{\text{IN}} = 100\text{ MHz}$		84			82		
		$f_{\text{IN}} = 230\text{ MHz}$	65	79			76		
		$f_{\text{IN}} = 450\text{ MHz}$		72			72		
		$f_{\text{IN}} = 700\text{ MHz}$		66			69		
SINAD	Signal to noise and distortion ratio	$f_{\text{IN}} = 10\text{ MHz}$		61.0			61.1		dBc
		$f_{\text{IN}} = 100\text{ MHz}$		60.8			61.0		
		$f_{\text{IN}} = 230\text{ MHz}$	57.5	60.5			60.8		
		$f_{\text{IN}} = 450\text{ MHz}$		59.8			60.3		
		$f_{\text{IN}} = 700\text{ MHz}$		58.4			59.4		
THD	Total Harmonic Distortion	$f_{\text{IN}} = 10\text{ MHz}$		76			76		dBc
		$f_{\text{IN}} = 100\text{ MHz}$		73			76		
		$f_{\text{IN}} = 230\text{ MHz}$	66	74			74		
		$f_{\text{IN}} = 450\text{ MHz}$		74			73		
		$f_{\text{IN}} = 700\text{ MHz}$		72			74		
IMD3	Inter modulation distortion	$F_{\text{in}} = 184.5\text{ and }185.5\text{ MHz, } -7\text{ dBFS}$		82			83		dBFS
		$F_{\text{in}} = 549.5\text{ and }550.5\text{ MHz, } -7\text{ dBFS}$		76			77		
	Crosstalk			90			90		dB
ENOB	Effective number of bits	$f_{\text{IN}} = 230\text{ MHz}$		9.8			9.8		LSB

(1) SFDR and SNR calculations do not include the DC or Fs/2 bins when Auto Correction is disabled.

## 7.8 Electrical Characteristics

Typical values at  $T_A = 25^\circ\text{C}$ , full temperature range is  $T_{\text{MIN}} = -40^\circ\text{C}$  to  $T_{\text{MAX}} = 85^\circ\text{C}$ , ADC sampling rate = 500 Msps, 50% clock duty cycle, AVDD33 = 3.3 V, AVDDC/AVDD18/DVDD/DVDDLVS/IOVDD = 1.8 V, -1-dBFS differential input (unless otherwise noted).

PARAMETER	TEST CONDITIONS	MIN	TYP	MAX	UNITS
<b>OVER-DRIVE RECOVERY ERROR</b>					
Input overload recovery	Recovery to within 5% (of final value) for 6-dB overload with sine wave input		2		ns
<b>SAMPLE TIMING CHARACTERISTICS</b>					
rms Aperture Jitter	Sample uncertainty		100		fs rms
Data Latency	ADC sample to digital output, Auto correction disabled		38		Clock Cycles
	ADC sample to digital output, Auto correction enabled		50		
	ADC sample to digital output, Decimation filter enabled, Auto correction disabled		74		Sampling clock Cycles
Over-range Latency	ADC sample to over-range output		12		Clock Cycles

## 7.9 Electrical Characteristics

The DC specifications refer to the condition where the digital outputs are not switching, but are permanently at a valid logic level 0 or 1. AVDD33 = 3.3 V, AVDDC/AVDD18/DVDD/DVDDLVS/IOVDD = 1.8 V

PARAMETER	TEST CONDITIONS	MIN	TYP	MAX	UNITS	
<b>DIGITAL INPUTS - SRESET, SCLK, SDENB, SDIO, ENABLE</b>						
High-level input voltage	All digital inputs support 1.8-V and 3.3-V logic levels.	0.7 x IOVDD			V	
Low-level input voltage				0.3 x IOVDD	V	
High-level input current		- 50		200	$\mu\text{A}$	
Low-level input current		- 50		50	$\mu\text{A}$	
Input capacitance			5		pF	
<b>DIGITAL OUTPUTS - SDO</b>						
High-level output voltage	Iload = -100 $\mu\text{A}$	IOVDD - 0.2			V	
	Iload = -2 mA	0.8 x IOVDD				
Low-level output voltage	Iload = 100 $\mu\text{A}$			0.2	V	
	Iload = 2 mA			0.22 x IOVDD		
<b>DIGITAL INPUTS - SYNC/P/N, TRIGGER/P/N</b>						
V <sub>ID</sub>	Differential input voltage	250	350	450	mV	
V <sub>CM</sub>	Input common-mode voltage	1.125	1.2	1.375	V	
t <sub>SU</sub>		500			ps	
<b>DIGITAL OUTPUTS - DA[11:0]P/N, DACLKP/N, OVRAP/N, SYNCOUTP/N, TRDYP/N, HRESP/N</b>						
V <sub>OD</sub>	Output differential voltage	Iout = 3.5 mA	250	350	450	mV
V <sub>OCM</sub>	Output common-mode voltage	Iout = 3.5 mA	1.125	1.25	1.375	V
t <sub>SU</sub>	F <sub>s</sub> = 750 Msps	Data valid to zero-crossing of DACLK	320	400		ps
t <sub>h</sub>	F <sub>s</sub> = 750 Msps	Zero-crossing of DACLK to data becoming invalid	250	320		ps

### 7.9 Electrical Characteristics (continued)

The DC specifications refer to the condition where the digital outputs are not switching, but are permanently at a valid logic level 0 or 1. AVDD33 = 3.3 V, AVDDC/AVDD18/DVDD/DVDDLVD/IOVDD = 1.8 V

PARAMETER	TEST CONDITIONS	MIN	TYP	MAX	UNITS
$t_{PD}$	$F_s = 750\text{Mps}$ CLKIN falling edge to DACLK rising edge	3.36	3.69	3.92	ns
$t_{RISE}$	10% - 90%	100	150	200	ps
$t_{FALL}$	90% - 10%	100	150	200	ps



图 7-1. Timing Diagram for 12-Bit DDR Output

## 7.10 Typical Characteristics

Typical values at  $T_A = +25^\circ\text{C}$ , full temperature range is  $T_{\text{MIN}} = -40^\circ\text{C}$  to  $T_{\text{MAX}} = +85^\circ\text{C}$ , ADC sampling rate = 750 Msps, 50% clock duty cycle, AVDD33 = 3.3 V, AVDDC/AVDD18/DVDD/DVDDLVD/IOVDD = 1.8 V, -1-dBFS differential input, unless otherwise noted.

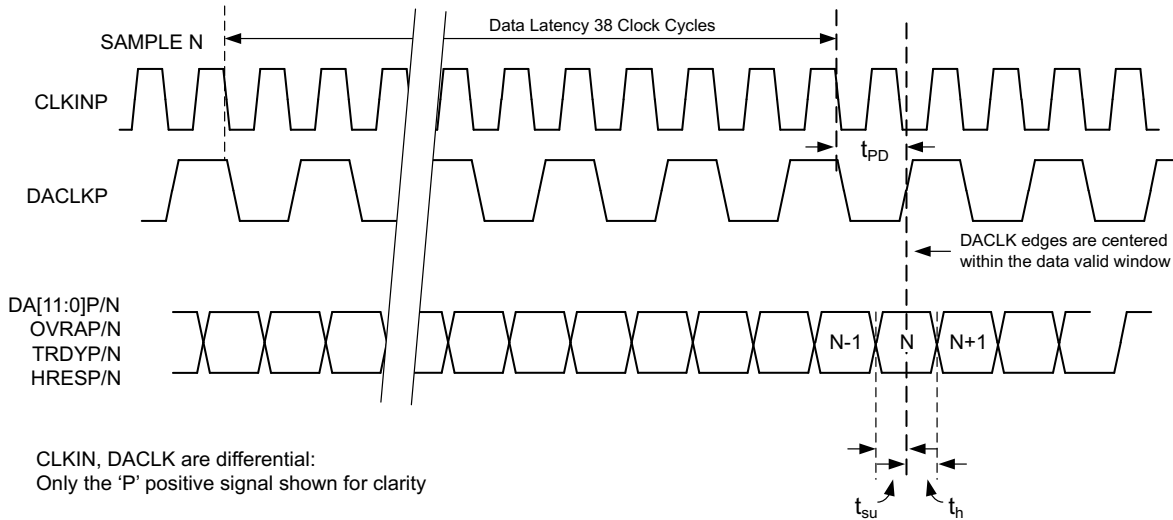

图 7-2. FFT for 10-MHz Input Signal (Auto On)



图 7-3. FFT for 10-MHz Input Signal (Auto Off)

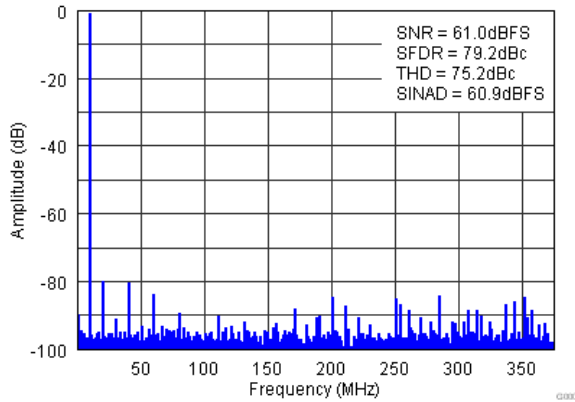

图 7-4. FFT for 230-MHz Input Signal (Auto On)

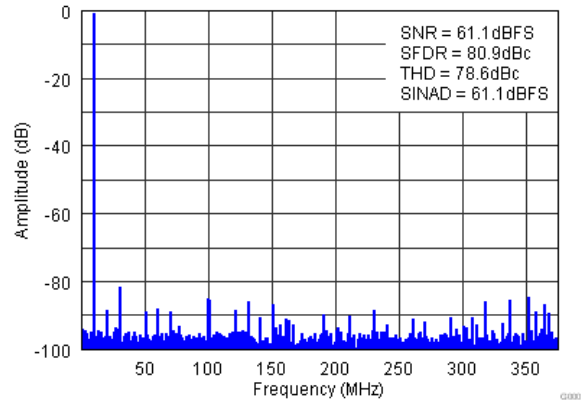

图 7-5. FFT for 230-MHz Input Signal (Auto Off)

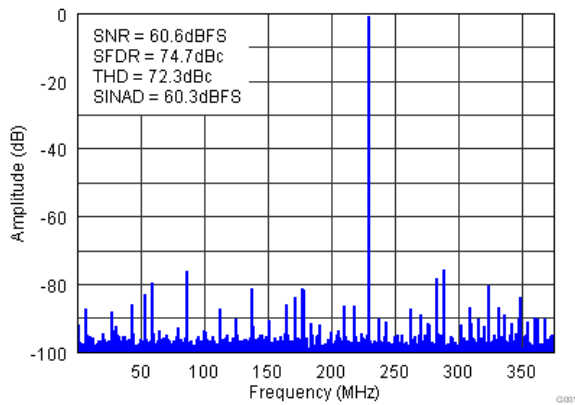

图 7-6. FFT for 450-MHz Input Signal (Auto On)

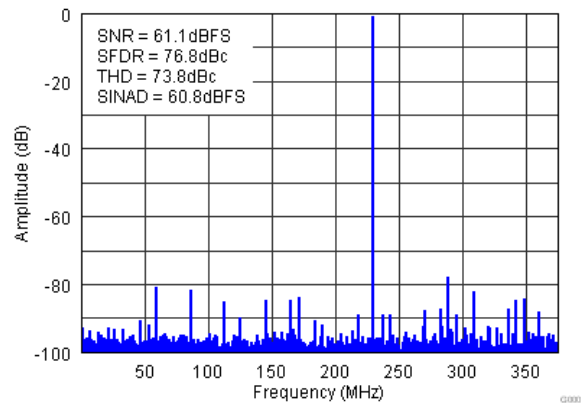

图 7-7. FFT for 450-MHz Input Signal (Auto Off)

### 7.10 Typical Characteristics (continued)

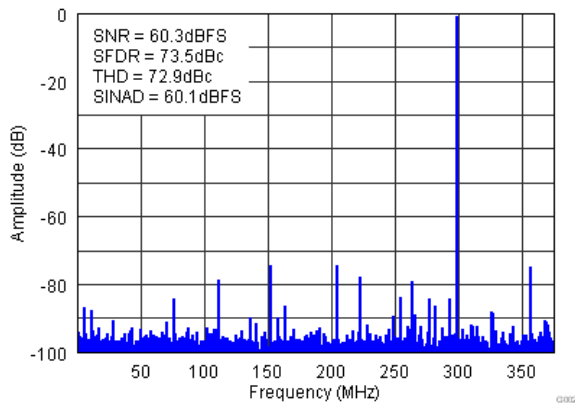
Typical values at  $T_A = +25^\circ\text{C}$ , full temperature range is  $T_{\text{MIN}} = -40^\circ\text{C}$  to  $T_{\text{MAX}} = +85^\circ\text{C}$ , ADC sampling rate = 750 Msps, 50% clock duty cycle, AVDD33 = 3.3 V, AVDDC/AVDD18/DVDD/DVDDLVD/IOVDD = 1.8 V, -1-dBFS differential input, unless otherwise noted.

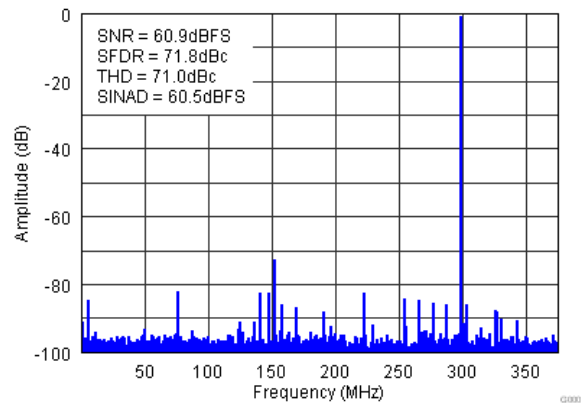

图 7-8. FFT for 700-MHz Input Signal (Auto On)



图 7-9. FFT for 700-MHz Input Signal (Auto Off)

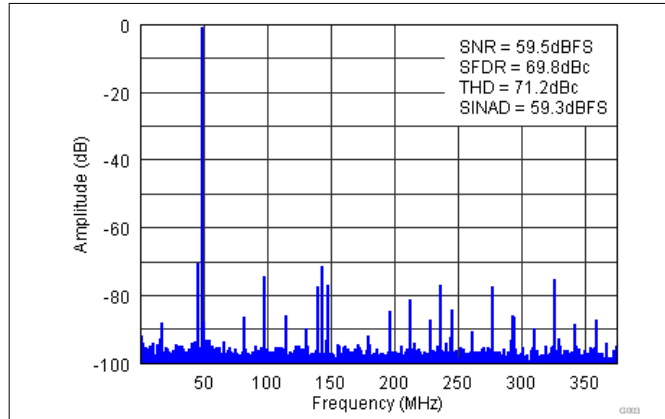

图 7-10. SFDR vs. Input Frequency

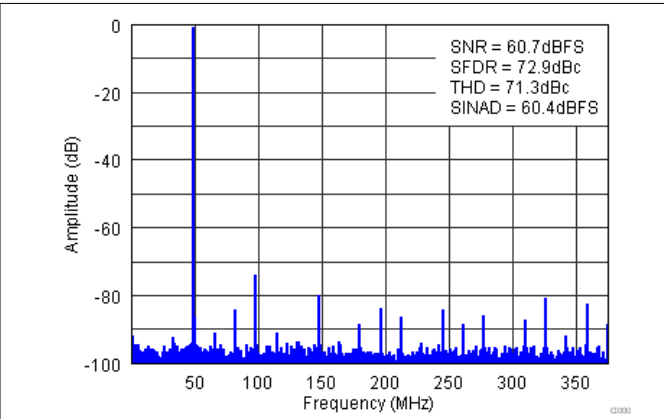

图 7-11. SNR vs. Input Frequency

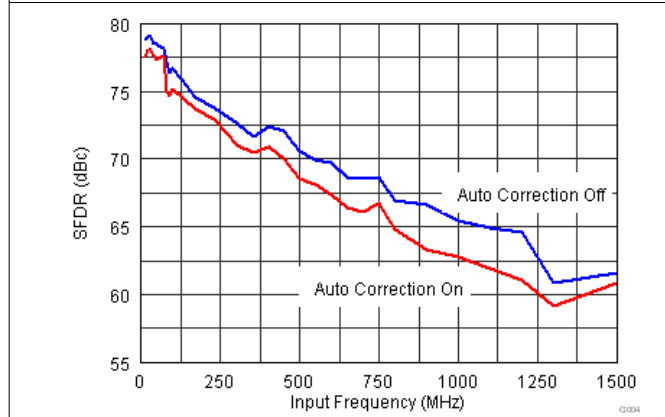

图 7-12. SFDR vs. Amplitude (fin = 230 MHz)

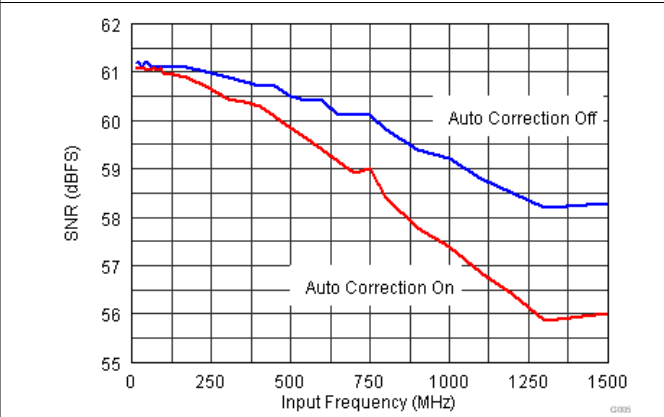

图 7-13. SNR vs. Amplitude (fin = 230 MHz)

### 7.10 Typical Characteristics (continued)

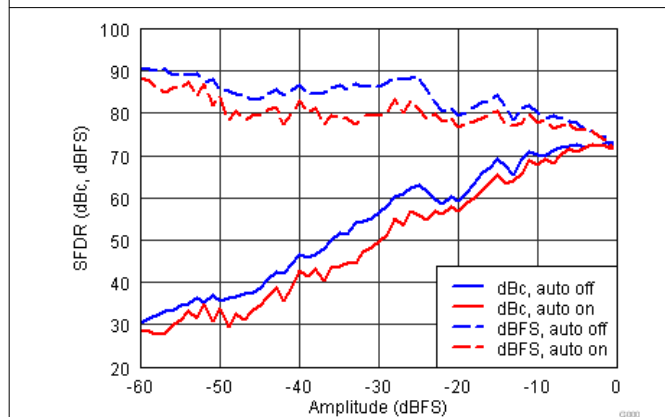
Typical values at  $T_A = +25^\circ\text{C}$ , full temperature range is  $T_{\text{MIN}} = -40^\circ\text{C}$  to  $T_{\text{MAX}} = +85^\circ\text{C}$ , ADC sampling rate = 750 Msps, 50% clock duty cycle, AVDD33 = 3.3 V, AVDDC/AVDD18/DVDD/DVDDLVS/IOVDD = 1.8 V, -1-dBFS differential input, unless otherwise noted.

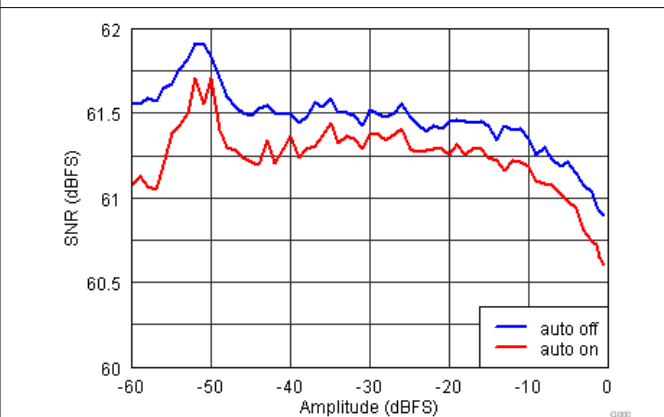

图 7-14. Tow Tone Performance Across Input Amplitude ( $f_{\text{in}} = 185 \text{ MHz}$ )



图 7-15. SFDR vs. Vref (Auto On)

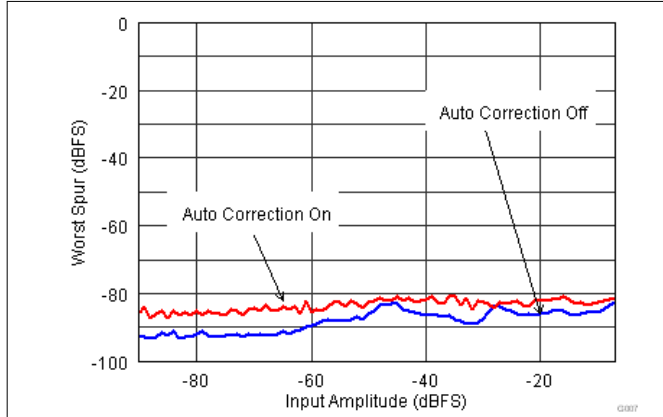

图 7-16. SFDR vs. Vref (Auto Off)

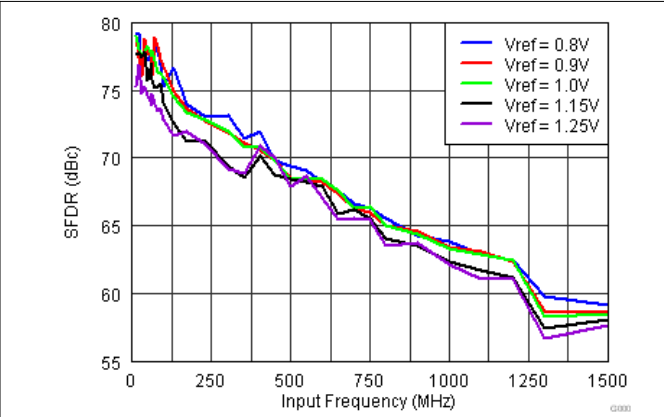

图 7-17. SNR vs. Vref (Auto On)

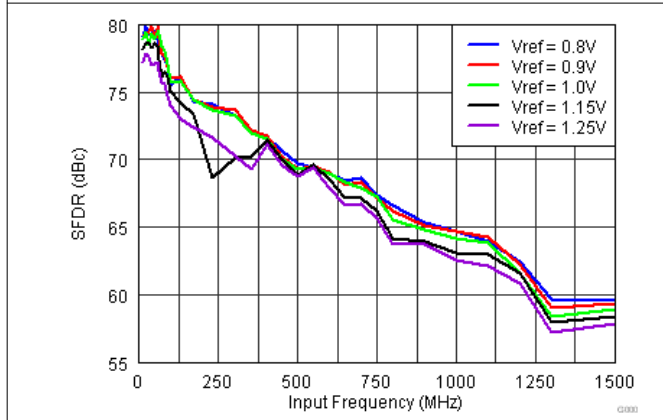

图 7-18. SNR vs. Vref (Auto Off)

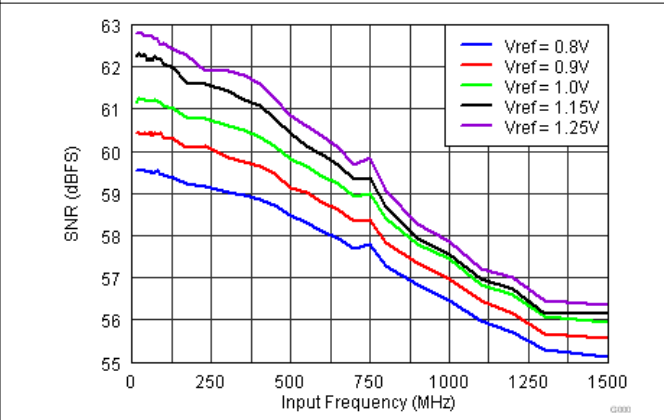

图 7-19. Performance Across Input Common-Mode Voltage

### 7.10 Typical Characteristics (continued)

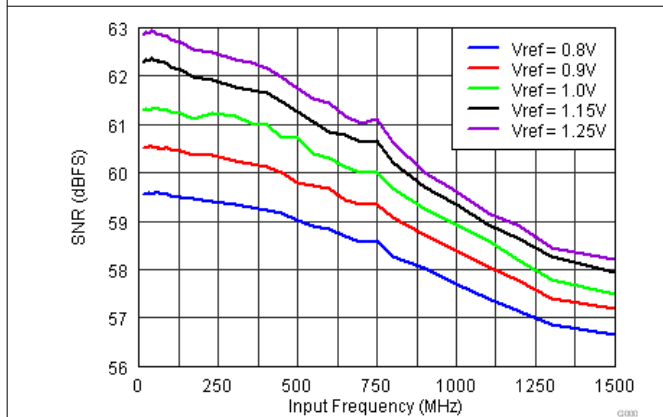
Typical values at  $T_A = +25^\circ\text{C}$ , full temperature range is  $T_{\text{MIN}} = -40^\circ\text{C}$  to  $T_{\text{MAX}} = +85^\circ\text{C}$ , ADC sampling rate = 750 Msps, 50% clock duty cycle, AVDD33 = 3.3 V, AVDDC/AVDD18/DVDD/DVDDLVDVS/IOVDD = 1.8 V, -1-dBFS differential input, unless otherwise noted.

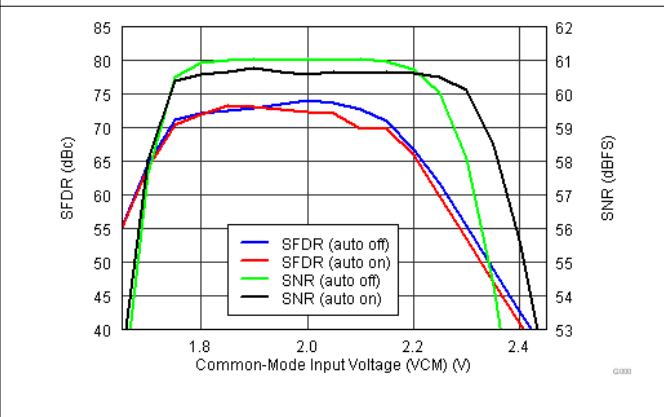

图 7-20. Performance Across Temperature (fin = 230 MHz)



图 7-21. Performance Across AVDD33 (fin = 230 MHz)

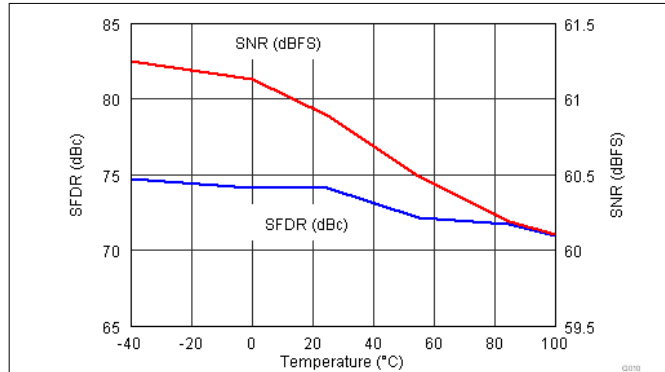

图 7-22. Performance Across AVDD18 (fin = 230 MHz)

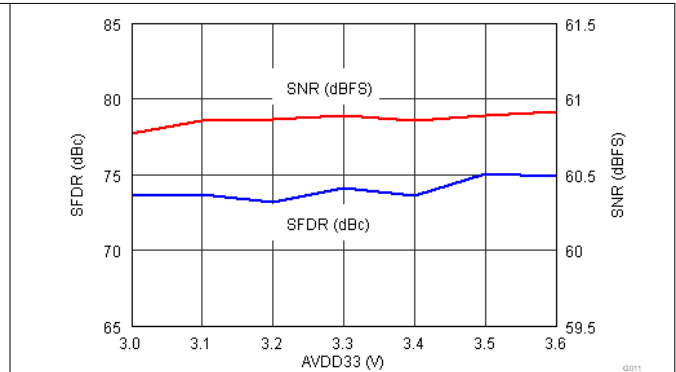

图 7-23. Performance Across Clock Amplitude

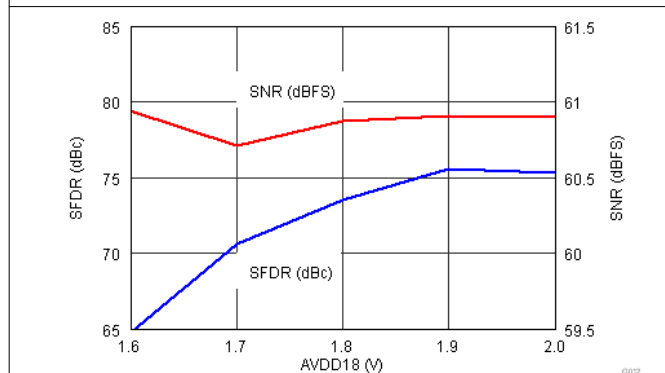

图 7-24. INL

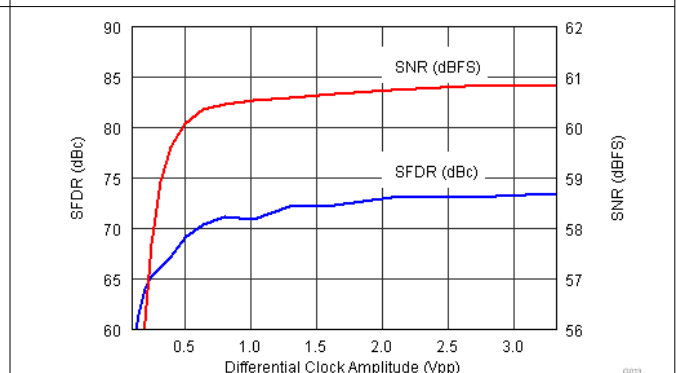

图 7-25. DNL

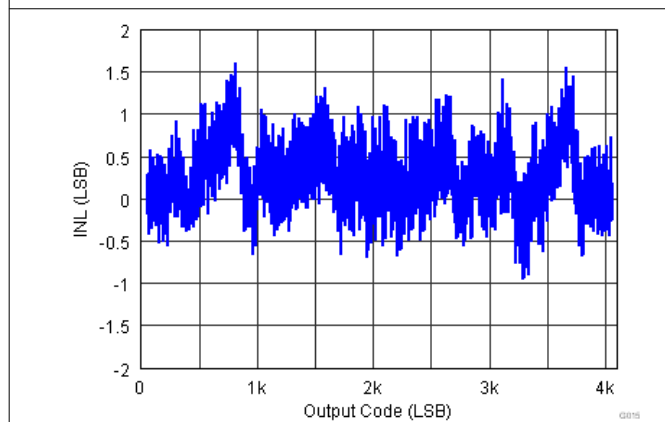

### 7.10 Typical Characteristics (continued)

Typical values at  $T_A = +25^\circ\text{C}$ , full temperature range is  $T_{\text{MIN}} = -40^\circ\text{C}$  to  $T_{\text{MAX}} = +85^\circ\text{C}$ , ADC sampling rate = 750 Msps, 50% clock duty cycle, AVDD33 = 3.3 V, AVDD18/DVDD/DVDDLVD/IOVDD = 1.8 V, -1-dBFS differential input, unless otherwise noted.

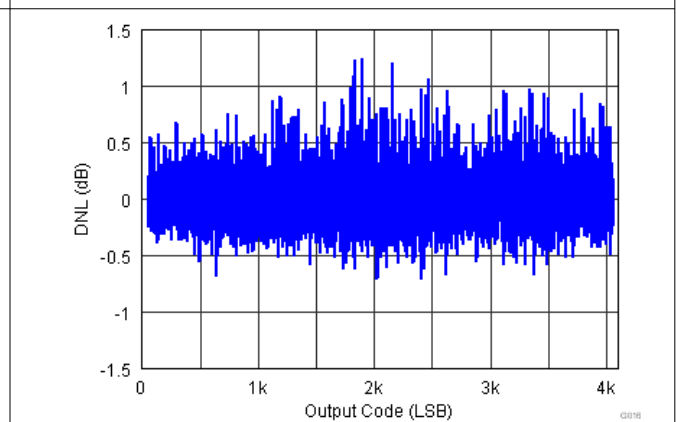
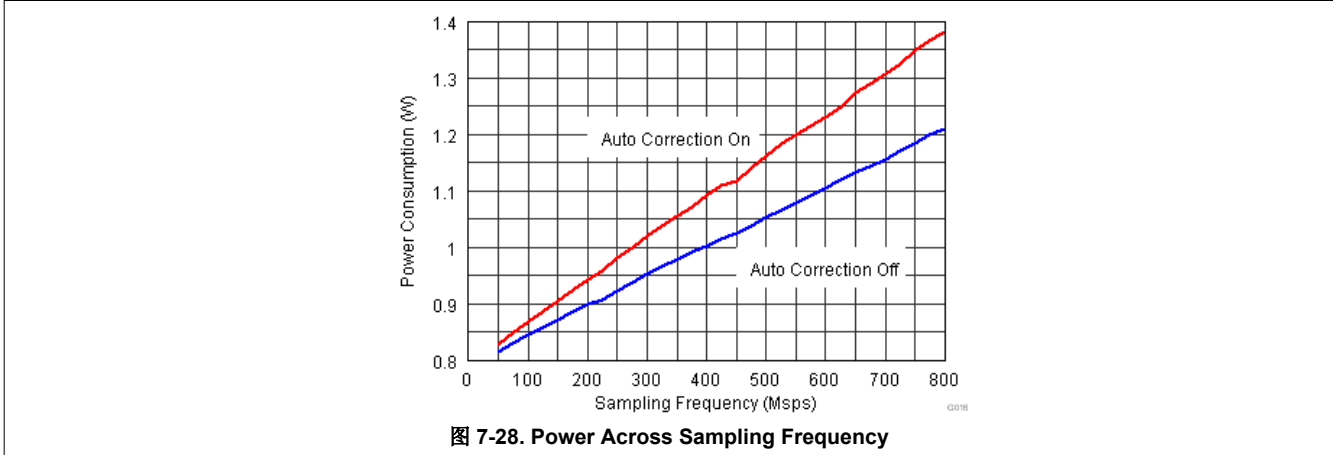
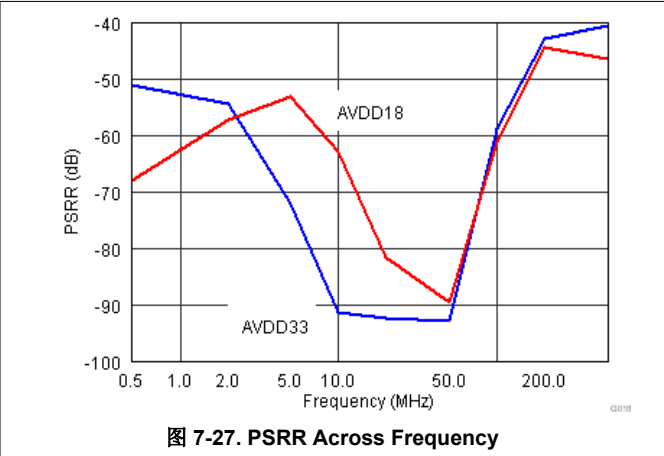
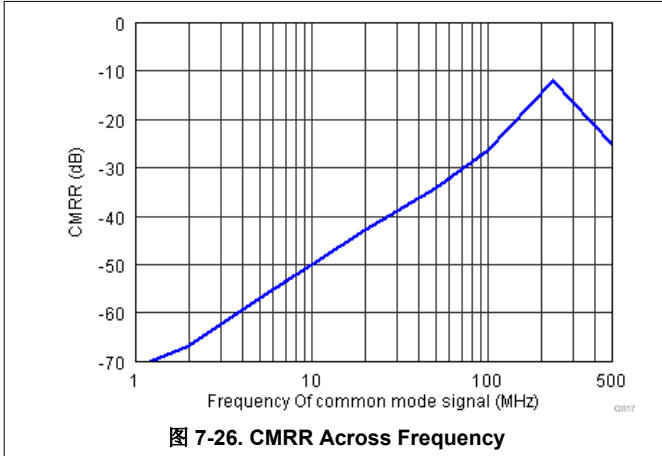

### 7.10 Typical Characteristics (continued)

Typical values at  $T_A = +25^\circ\text{C}$ , full temperature range is  $T_{\text{MIN}} = -40^\circ\text{C}$  to  $T_{\text{MAX}} = +85^\circ\text{C}$ , ADC sampling rate = 750 Msps, 50% clock duty cycle, AVDD33 = 3.3 V, AVDDC/AVDD18/DVDD/DVDDLVDVS/IOVDD = 1.8 V, -1-dBFS differential input, unless otherwise noted.



图 7-29. SFDR Across Input and Sampling Frequencies (Auto On)

### 7.10 Typical Characteristics (continued)

Typical values at  $T_A = +25^\circ\text{C}$ , full temperature range is  $T_{\text{MIN}} = -40^\circ\text{C}$  to  $T_{\text{MAX}} = +85^\circ\text{C}$ , ADC sampling rate = 750 Msps, 50% clock duty cycle, AVDD33 = 3.3 V, AVDDC/AVDD18/DVDD/DVDDLVDVS/IOVDD = 1.8 V, -1-dBFS differential input, unless otherwise noted.

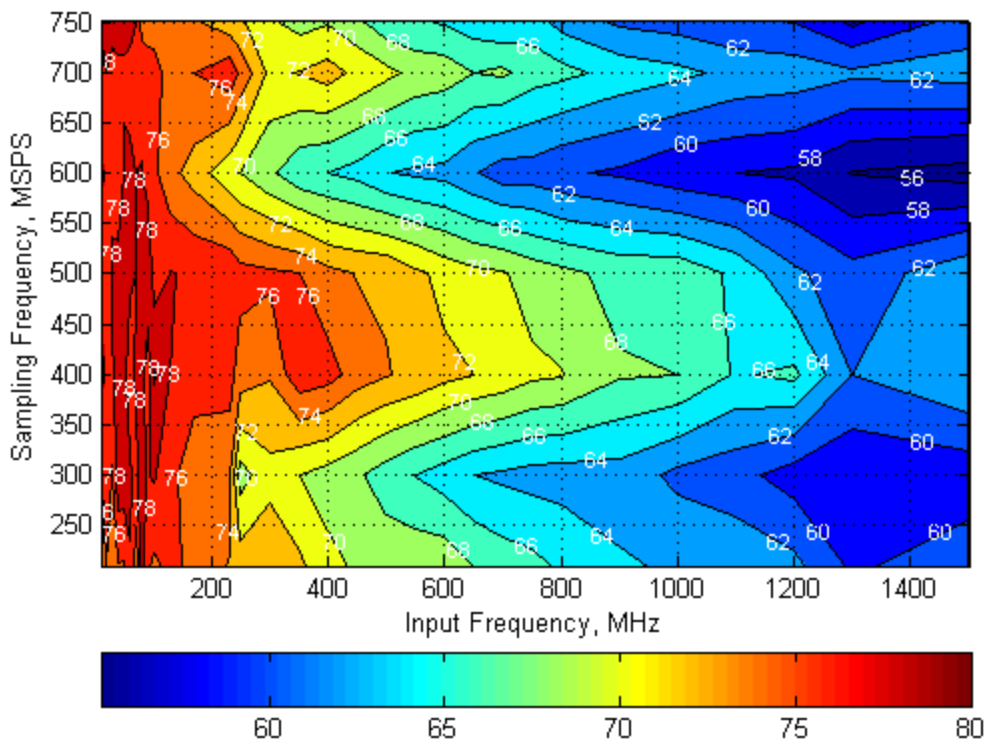

图 7-30. SFDR Across Input and Sampling Frequencies (Auto Off)

### 7.10 Typical Characteristics (continued)

Typical values at  $T_A = +25^\circ\text{C}$ , full temperature range is  $T_{\text{MIN}} = -40^\circ\text{C}$  to  $T_{\text{MAX}} = +85^\circ\text{C}$ , ADC sampling rate = 750 Msps, 50% clock duty cycle, AVDD33 = 3.3 V, AVDDC/AVDD18/DVDD/DVDDLVDVS/IOVDD = 1.8 V, -1-dBFS differential input, unless otherwise noted.

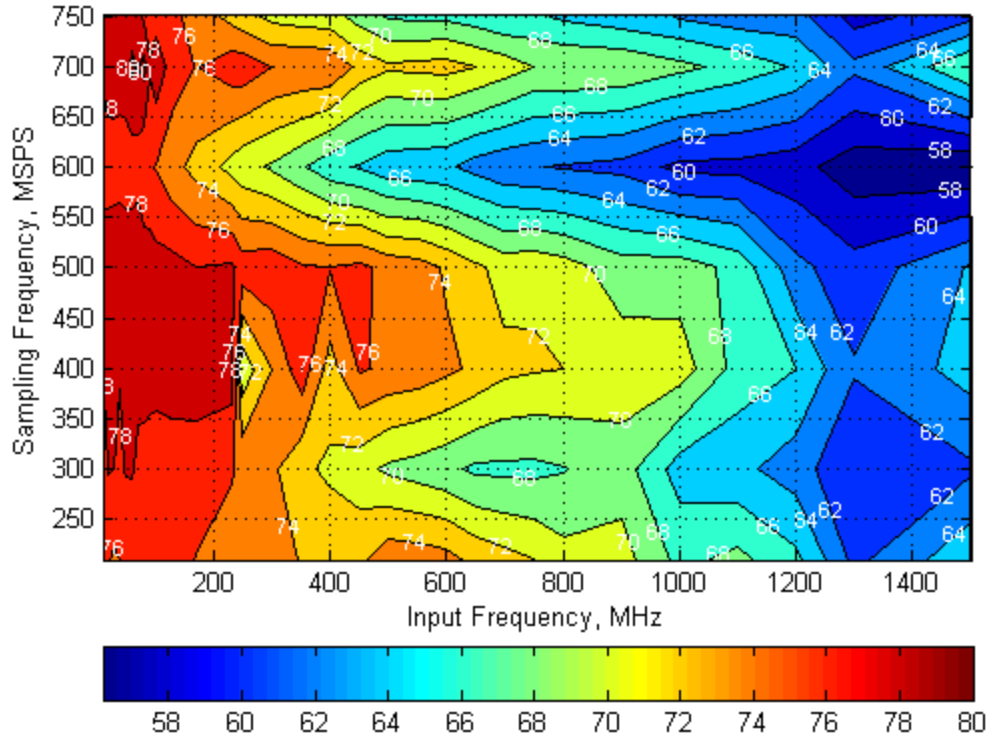

图 7-31. SNR Across Input and Sampling Frequencies (Auto On)

### 7.10 Typical Characteristics (continued)

Typical values at  $T_A = +25^\circ\text{C}$ , full temperature range is  $T_{\text{MIN}} = -40^\circ\text{C}$  to  $T_{\text{MAX}} = +85^\circ\text{C}$ , ADC sampling rate = 750 Msps, 50% clock duty cycle, AVDD33 = 3.3 V, AVDDC/AVDD18/DVDD/DVDDLVDVS/IOVDD = 1.8 V, -1-dBFS differential input, unless otherwise noted.

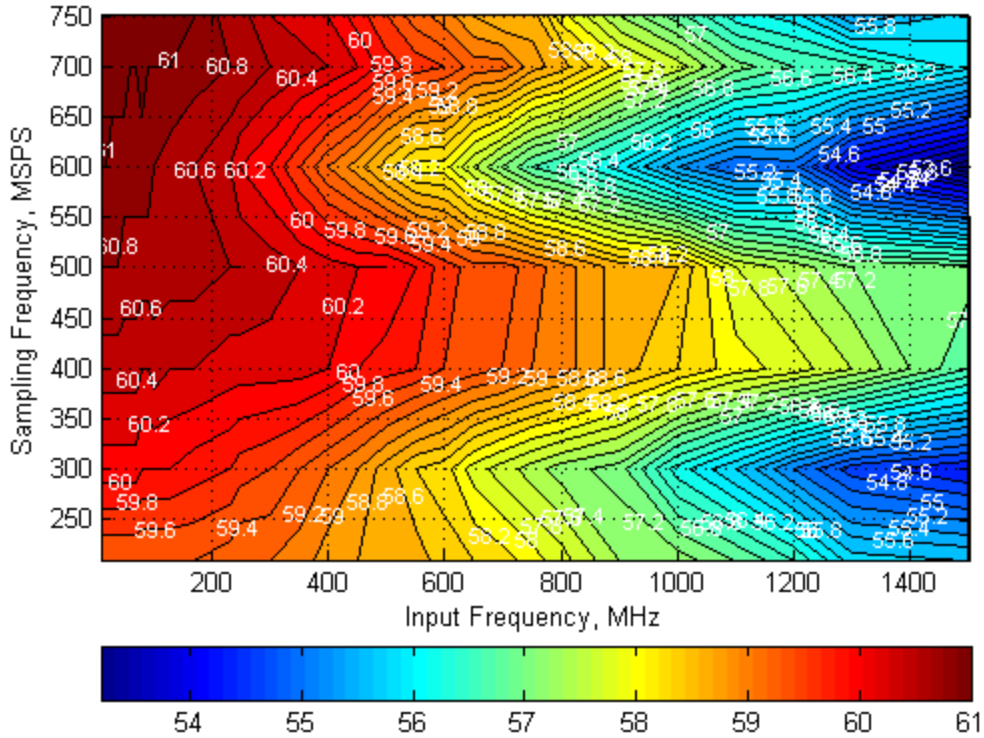

图 7-32. SNR Across Input and Sampling Frequencies (Auto On)

## 8 Detailed Description

### 8.1 Overview

The ADS54T01 is a 12-bit, single channel ADC that operates at sampling rates of up to 750 Msps. This device has excellent SFDR over a large input frequency range and low noise performance. The ADC accepts differential signals for the clock input and analog input buffers. The analog input buffer provides an isolated signal from the source with a high-impedance input.

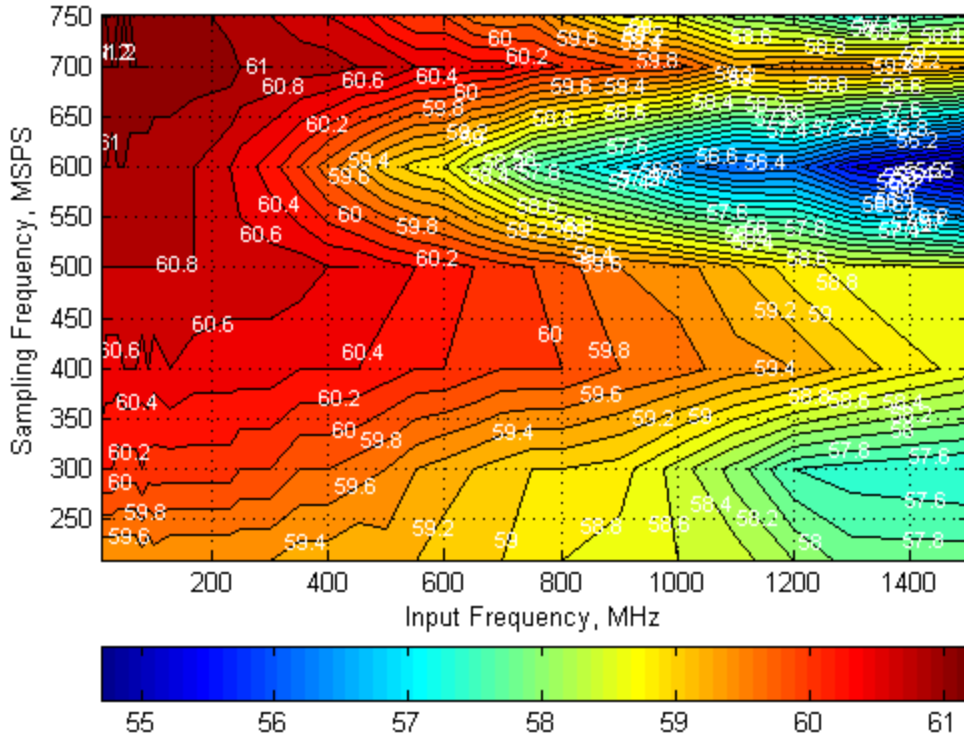
### 8.2 Functional Block Diagram



图 8-1. Functional Block Diagram

### 8.3 Feature Description

#### 8.3.1 Test Pattern Output

The ADS54T01 can be configured to output different test patterns that can be used to verify the digital interface is connected and working properly.

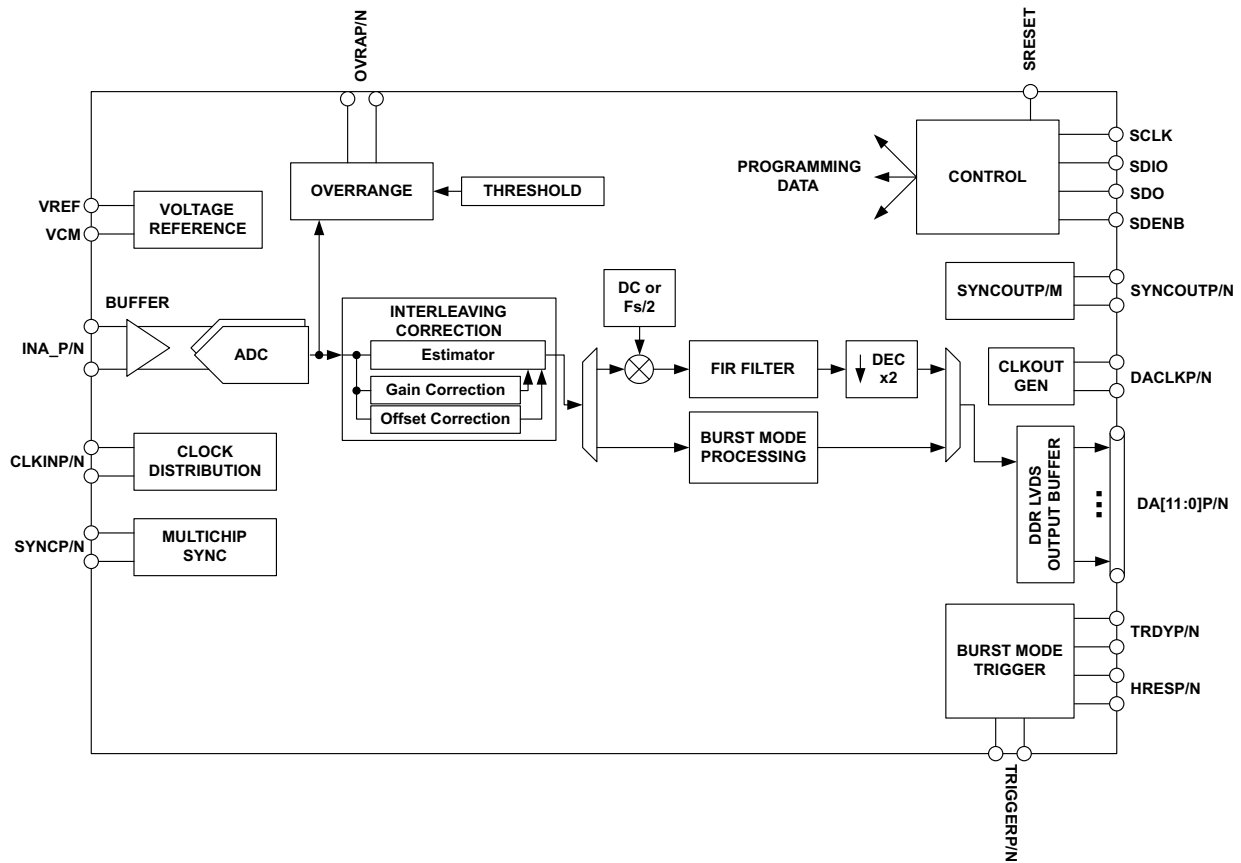
To enable the test pattern mode, the high-performance mode 1 has to be disabled first through the SPI register write. Then different test patterns can be selected by configuring registers x3C, x3D, and x3E. All three registers must be configured for the test pattern to work properly.

First set HP1 = 0 (Addr 0x01, D01)

Internally the test pattern replaces the sampled data from the ADC. However at the LVDS outputs the output data is still subject to burst mode operation. In low-resolution output, the LSBs of the test pattern are replaced with 0 s.



图 8-2. Test Pattern Selection

表 8-1. Test Pattern Register Setting

Register Address	All 0s	All 1s	Toggle (0xAAA => 0x555)	Toggle (0xFFF => 0x000)
0x3C	0x8000	0xBFFC	0x9554	0xBFFC
0x3D	0x0000	0x3FFC	0x2AA8	0x0000
0x3E	0x0000	0x3FFC	0x1554	0x3FFC

表 8-2. Custom Pattern Register Setting

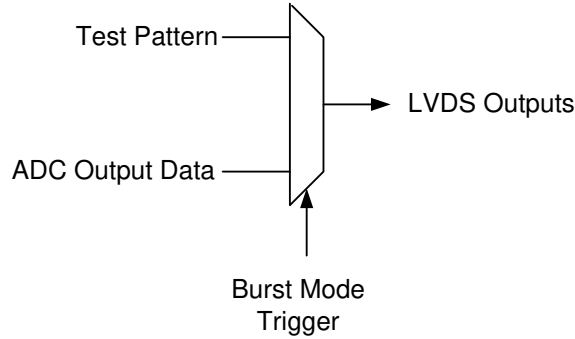
Register Address	Custom Pattern															
	D15	D14	D13	D12	D11	D10	D9	D8	D7	D6	D5	D4	D3	D2	D1	D0
x3C	1	0	D11	D10	D9	D8	D7	D6	D5	D4	D3	D2	D1	D0	0	0
x3D	0	0													0	0
x3E	0	0													0	0

For normal operation, set HP1 = 1 (Addr 0x01, D01) and 0x3C, 0x3D, and 0x3E all to 0.

### 8.3.2 Clock Inputs

The ADS54T01 clock input can be driven differentially with a sine wave, LVPECL, or LVDS source with little or no difference in performance. The common-mode voltage of the clock input is set to 0.9 V using internal 2-k $\Omega$  resistors. This allows for AC coupling of the clock inputs. The termination resistors should be placed as close to the clock inputs as possible to minimize signal reflections and jitter degradation.

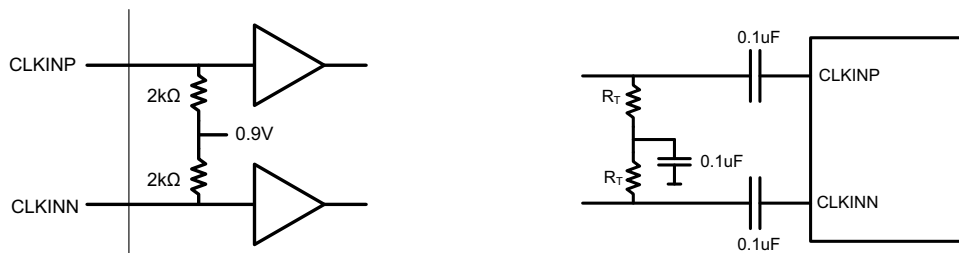

Recommended differential clock driving circuit

图 8-3. Recommended Differential Clock Driving Circuit

### 8.3.3 SNR and Clock Jitter

The signal-to-noise ratio of the ADC is limited by three different factors: the quantization noise is typically not noticeable in pipeline converters and is 72 dB for a 12-bit ADC. The thermal noise limits the SNR at low input frequencies while the clock jitter sets the SNR for higher input frequencies.

$$\text{SNR}_{\text{ADC}}[\text{dBc}] = -20 \times \log \sqrt{\left(10 - \frac{\text{SNR}_{\text{Quantization\_Noise}}}{20}\right)^2 + \left(10 - \frac{\text{SNR}_{\text{ThermalNoise}}}{20}\right)^2 + \left(10 - \frac{\text{SNR}_{\text{Jitter}}}{20}\right)^2} \quad (1)$$

Use 方程式 2 to calculate the SNR limitation due to sample clock jitter.

$$\text{SNR}_{\text{Jitter}}[\text{dBc}] = -20 \times \log(2\pi \times f_{\text{IN}} \times t_{\text{Jitter}}) \quad (2)$$

The total clock jitter ( $t_{\text{Jitter}}$ ) has three components: the internal aperture jitter (100 fs for ADS54T01) which is set by the noise of the clock input buffer, the external clock jitter, and the jitter from the analog input signal. Use 方程式 3 to calculate the total clock jitter.

$$T_{\text{Jitter}} = \sqrt{(T_{\text{Jitter,Ext.Clock\_Input}})^2 + (T_{\text{Aperture\_ADC}})^2} \quad (3)$$

External clock jitter can be minimized by using high-quality clock sources and jitter cleaners as well as bandpass filters at the clock input while a faster clock slew rate improves the ADC aperture jitter.

The ADS54T01 has a thermal noise of 61.2 dBFS and internal aperture jitter of 100 fs. 图 8-4 shows the SNR depending on amount of external jitter for different input frequencies.



图 8-4. SNR vs. Frequency and External Clock Jitter

### 8.3.4 Analog Inputs

The ADS54T01 analog signal input is designed to be driven differentially. The analog input pins have internal analog buffers that drive the sampling circuit. As a result of the analog buffer, the input pins present a high impedance input across a very wide frequency range to the external driving source which enables great flexibility in the external analog filter design as well as excellent 50  $\Omega$  matching for RF applications. The buffer also helps isolate the external driving circuit from the internal switching currents of the sampling circuit which results in a more constant SFDR performance across input frequencies.

The common-mode voltage of the signal inputs is internally biased to 1.9 V using 500- $\Omega$  resistors which allows for AC coupling of the input drive network. Each input pin (INP, INM) must swing symmetrically between ( $V_{\text{CM}} + 0.25 \text{ V}$ ) and ( $V_{\text{CM}} - 0.25 \text{ V}$ ), resulting in a 1.0 V<sub>pp</sub> (default) differential input swing. The input sampling circuit has a 3-dB bandwidth that extends up to 1.2 GHz.

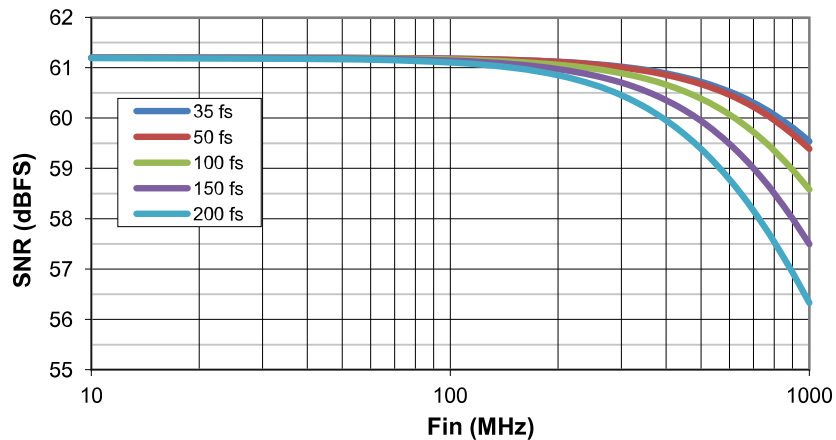



图 8-5. Analog Input Internal Circuitry

### 8.3.5 Over-Range Indication

The ADS54T01 provides a fast over-range indication on the OVRA/B pins. The fast OVR is triggered if the input voltage exceeds the programmable overrange threshold and it gets presented after just 12 clock cycles enabling a quicker reaction to an overrange event. The OVR threshold can be configured using SPI register writes.

The input voltage level at which the overload is detected is referred to as the threshold and is programmable using the over-range threshold bits. The threshold at which fast OVR is triggered is (full-scale × [the decimal value of the FAST OVR THRESH bits] / 16). After reset, the default value of the over-range threshold is set to 15 (decimal) which corresponds to a threshold of 0.56 dB below full scale ( $20 \times \log(15/16)$ ).

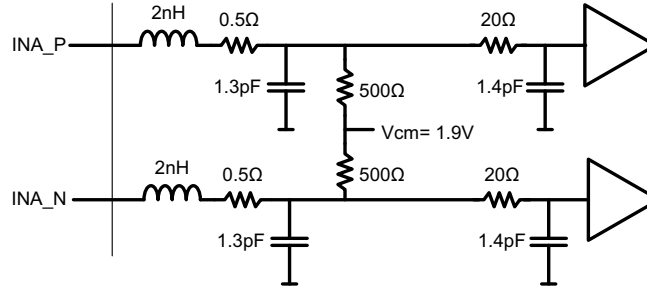

图 8-6. OVR Detection Threshold

### 8.3.6 Interleaving Correction

The data converter channel consists of two interleaved ADCs each operating at half of the ADC sampling rate but 180° out of phase from each other. The front end track and hold circuitry is operating at the full ADC sampling rate which minimizes the timing mismatch between the two interleaved ADCs. In addition, the ADS54T01 is equipped with internal interleaving correction logic that can be enabled through a SPI register write.

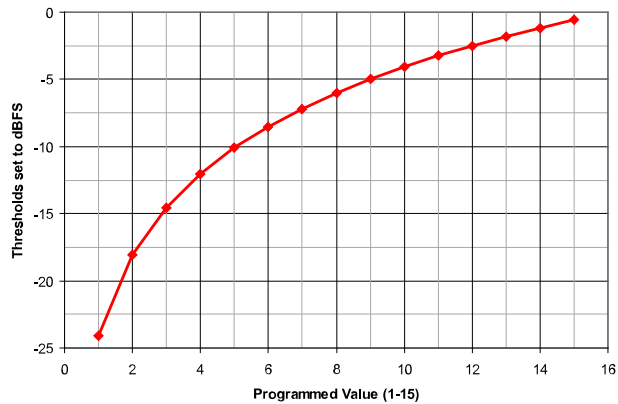

图 8-7. Interleaving Correction Block Diagram

The interleaving operation creates 2 distinct and interleaving products:

- $F_s/2 - F_{in}$ : this spur is created by gain timing mismatch between the ADCs. Since internally the front end track and hold is operated at the full sampling rate, this component is greatly improved and mostly dependent on gain mismatch.
- $F_s/2$  Spur: due to offset mismatch between ADCs

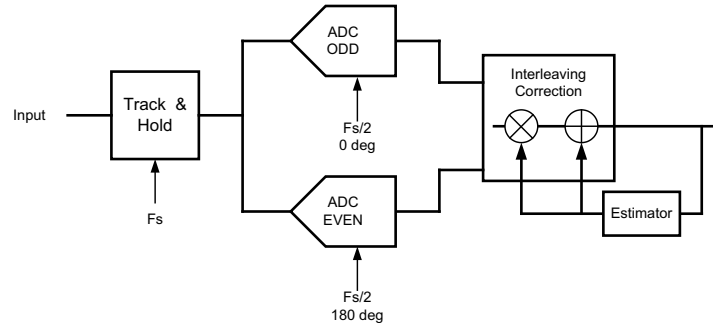

图 8-8. Interleaving Correction Spurs

The auto correction loop can be enabled through a SPI register write in address 0x01. By default, the auto correction function is disabled for lowest possible power consumption. The default settings for the auto correction function should work for most applications. However please contact Texas Instruments if further fine tuning of the algorithm is required.

The auto correction function yields best performance for input frequencies below 250 MHz.

### 8.3.7 High-Resolution Output Data

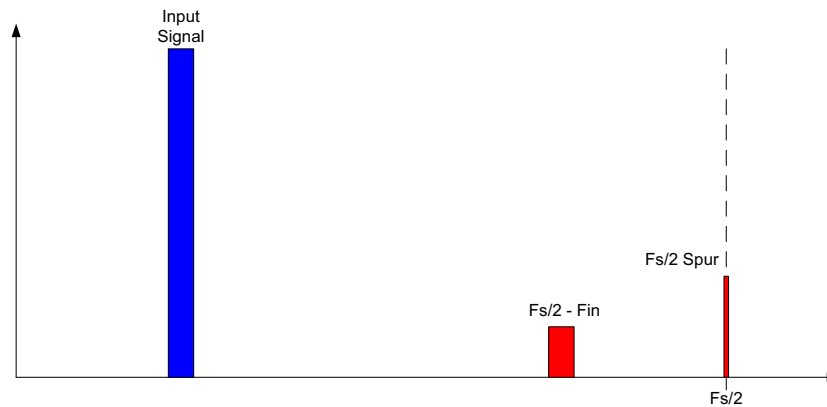
After trigger, the data outputs DA[11..0] are 12-bit resolution for  $2^N$  samples, where N is a programmable register with a range  $10 \leq N \leq 25$  (corresponding to 1024 to 33554432 samples).



图 8-9. High-Resolution Data Output Timing

After the high-resolution data, the data output returns to low-resolution mode, the logic level of the HRES flag returns low and the trigger is locked out for  $2^{(N+3)}$  samples. N is the sample integer resulting in a maximum output duty cycle of 1/9. During the trigger lockout time, a low to high transition on TRIGGERP/N will be ignored. After the  $2^{N+3}$  low-resolution samples, the TRIGGERP/N is re-enabled for the next valid data burst.

### 8.3.8 Low-Resolution Output Data

There are two different options for the low-resolution output data and the selection is made through SPI register control. The data can either be output at full speed (ADC sampling rate) with the output resolution limited to 7 bit (7 MSBs). Alternatively the output resolution can be selected to 11 bit (11 MSBs) but at a reduced effective data rate where every 4<sup>th</sup> sample gets repeated four times.

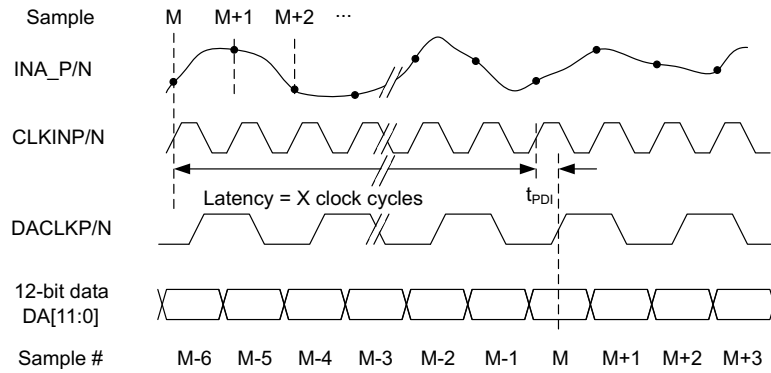
### 8.3.9 Full Speed – 7 Bit

The output data rate and timing is exactly the same as the high-resolution data, only the output resolution is limited to the 7 MSBs.



图 8-10. Full-Rate, Low-Resolution Output Data Timing

### 8.3.10 Decimated Low-Resolution Output Data

In decimated low-resolution mode, the output data is limited to 11 bits and every sample is repeated four times, so the effective data rate is 1/4 of ADC sampling rate. The latency of the ADC sample to output sample is exactly the same as for high-resolution data—there is no uncertainty in which conversion sample results in the valid output data. This is because the output continues to run at the ADC sample rate in decimated low-resolution mode where only the resolution is changed and three out of four samples are deleted.

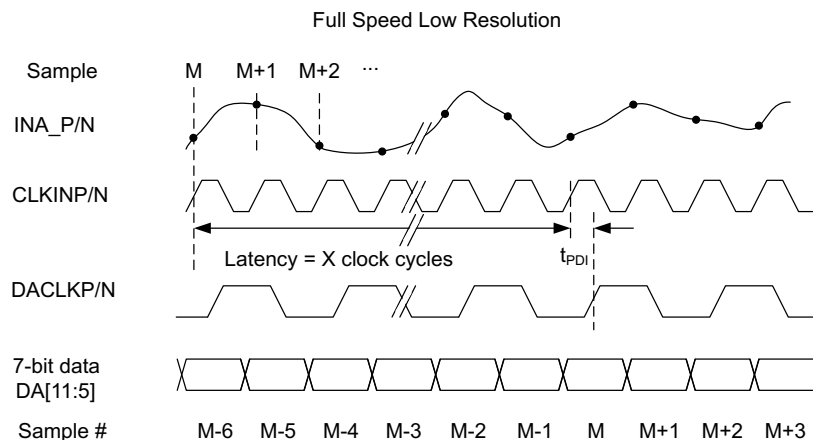
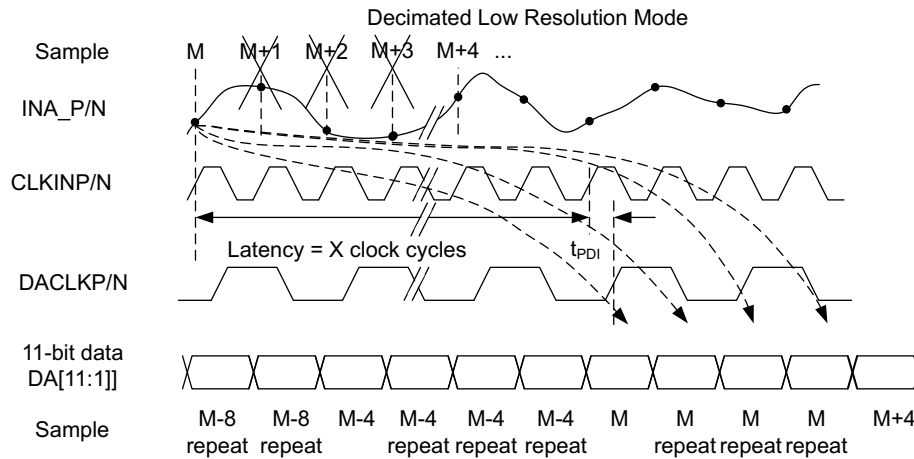

**图 8-11. Decimated Low-Resolution Output Data Timing Diagram**

### 8.3.11 Multi Device Synchronization

The ADS54T01 simplifies the synchronization of data from multiple ADCs in one common receiver. Upon receiving the initial SYNC input signal, the ADS54T01 resets all the internal clocks and digital logic while also starting a SYNCOUT signal which operates on a 5-bit counter (32 clock cycles). Therefore, by providing a common SYNC signal to multiple ADCs, their output data can be synchronized as the SYNCOUT signal marks a specific sample with the same latency in all ADCs. The SYNCOUT signal then can be used in the receiving device to synchronize the FIFO pointers across the different input data streams. Thus the output data of multiple ADCs can be aligned properly even if there are different trace lengths between the different ADCs.

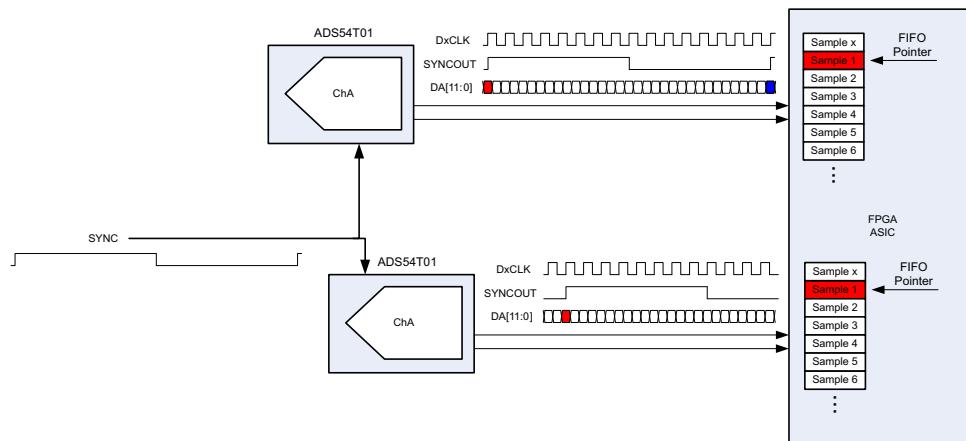

**图 8-12. Multi Device SYNC**

The SYNC input signal should be a one-time pulse to trigger the periodic 5-bit counter for SYNCOUT or a periodic signal repeating every 32 CLKIN clock cycles. The signal is registered on the rising edge of the ADC input clock (CLKIN). Upon registering the initial rising edge of the SYNC signal, the internal clocks and logic get reset which results in invalid output data for 36 samples (1 complete sync cycle and 4 additional samples). The SYNCOUT signal starts with the next output clock (DACLK) rising edge and operates on a 5-bit counter. If a SYNCIN rising edge gets registered at a new position, the counter gets reset and SYNCOUT starts from the new position.

The ADS54T01 output interface operates with a DDR clock, therefore the synchronization can happen on the rising edge or falling edge sample. Synchronization on the falling edge sample will result in a half cycle clock stretch of DACLK. For convenience, the SYNCOUT signal is available on the ChA output LVDS bus.

When using decimation, the SYNCOUT signal still operates on 32 clock cycles of CLKIN, but because the output data is decimated by 2, only the first 18 samples should be discarded.



图 8-13. SYNC Timing Diagram

## 8.4 Device Functional Modes

### 8.4.1 Power-Down Modes

The ADS54T01 can be configured through a SPI write (address x37) to a standby, light, or deep sleep power mode which is controlled by the ENABLE pin. The sleep modes are active when the ENABLE pin goes low. Different internal functions stay powered up which results in different power consumption and wake up time between the two sleep modes.

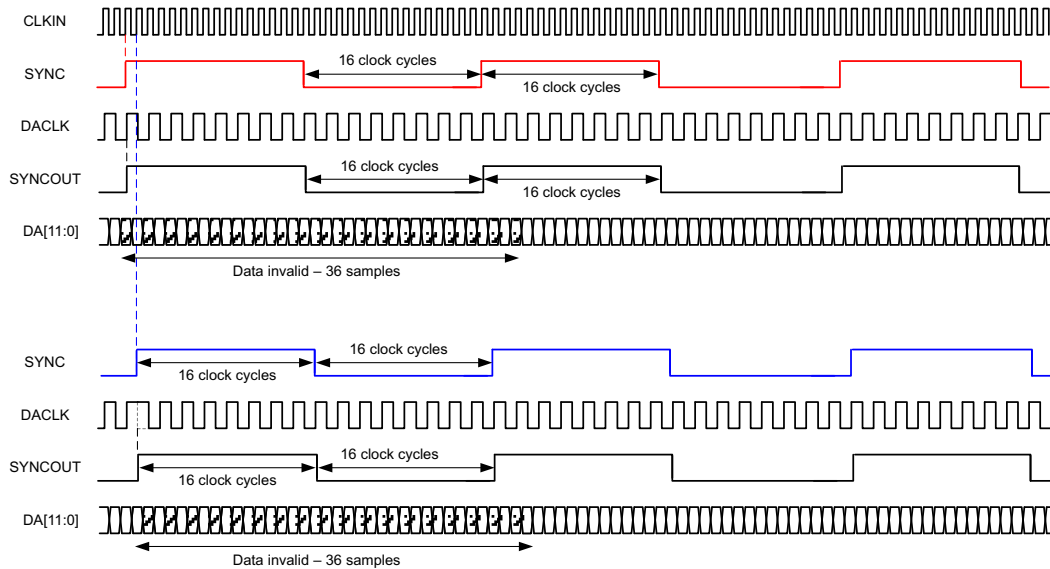
表 8-3. Sleep Mode Power Consumption

Sleep Mode	Wake-Up Time	Power Consumption With Auto Correction Disabled	Power Consumption With Auto Correction Enabled
Complete Shutdown	2.5 ms	7 mW	7 mW
Standby	100 $\mu$ s	7 mW	7 mW
Deep Sleep	20 $\mu$ s	350 mW	475 mW
Light Sleep	2 $\mu$ s	655 mW	780 mW

### 8.4.2 Feedback Mode: Burst Mode

In burst mode, the output data is alternated between a high-resolution, 12-bit output of  $2^N$  samples and a low-resolution, 7-bit or 11-bit output of  $2^{N+3}$  samples. Burst mode is enabled through a SPI register write and there are two basic operating modes available: a manual trigger mode where the high-resolution output is initiated through an external trigger and an auto-trigger mode where the internal logic transitions to a high-resolution output immediately after transmitting the last low-resolution sample. After burst mode is enabled through a SPI register write, the ADS54T01 transmits  $2^{13}$  low-resolution samples and the trigger command is locked out until completion.

The parameter N can be changed through the SPI at any time. The change will go into effect with the next output cycle, starting with the transmission of low-resolution samples. The default value for N after reset is N=10.

表 8-4. Burst Mode Samples Per Cycle

N limit	10 (minimum)	25 (maximum)
Number of low resolution samples per cycle ( $2^{N+3}$ )	8,192	268,435,456
Number of high resolution samples per cycle ( $2^N$ )	1,024	33,554,432
Total amount of samples per cycle	9,216	301,989,888

**表 8-4. Burst Mode Samples Per Cycle (continued)**

N limit	10 (minimum)	25 (maximum)
Maximum number of high resolution (12-bit) samples per 1 second	83.3M	83.3M

**8.4.3 Receive Mode: Decimation Filter**

图 8-14 shows that each channel has a digital filter in the data path.

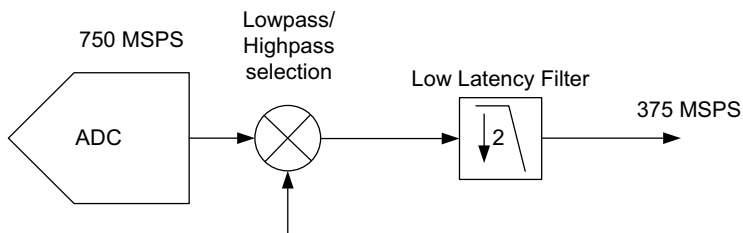

**图 8-14. Decimation Filter Block Diagram**

The filter can be programmed as a low-pass or a high-pass filter and the normalized frequency response of both filters. The decimation filter response has a 0.1-dB pass-band ripple with approximately 41% pass-band bandwidth. The stop-band attenuation is approximately 40 dB.

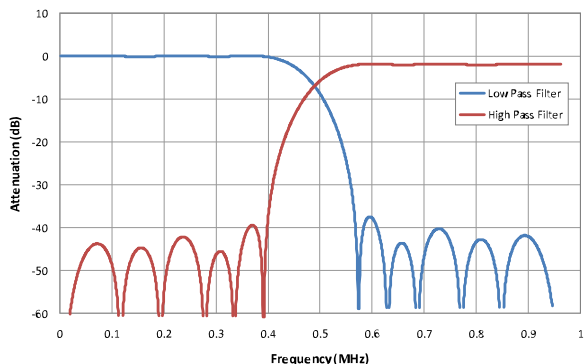

**图 8-15. Decimation Filter Response**

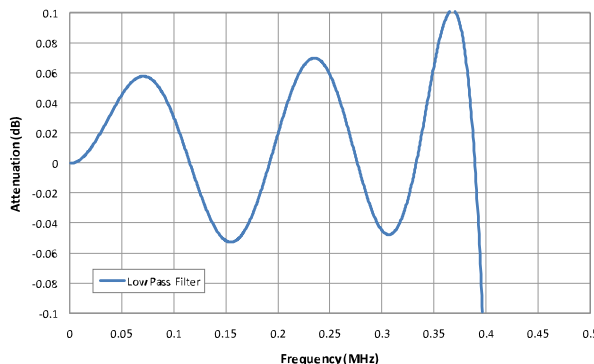

**图 8-16. Decimation Filter Response**

**8.4.4 Manual Trigger Mode**

The control of the high-resolution output is shown below along with the two output flags (TRDY and HRES).



图 8-17. Triggering High Resolution Mode and Lockout Time

After enabling burst mode, the output data DA[11..0] are forced to low-resolution mode for  $2^{13}$  samples. During that period, any trigger signal is ignored. The completion of the low-resolution sample cycle is signaled by a logic high on the TRDY output pins indicating that a high-resolution (12-bit) data output burst can be triggered by a low-to-high transition on the TRIGGER input. The ADC monitors the TRIGGER input at each rising edge of the input clock.

The high-resolution output data starts with a delay of  $t_{TRIG\_DELAY} = 1-2$  DACLK clock cycles and is indicated through the HRES data flag which stays high for all  $2^N$  high-resolution samples. At completion the register value for N is verified and transmission of  $2^{(N+3)}$  low-resolution data immediately follows. When the last low-resolution sample is output on the output data bus, the flag TRDY is asserted high again indicating the end of the lockout period and the next  $2^N$  high-resolution samples can be triggered again.

#### 8.4.5 Auto Trigger Mode

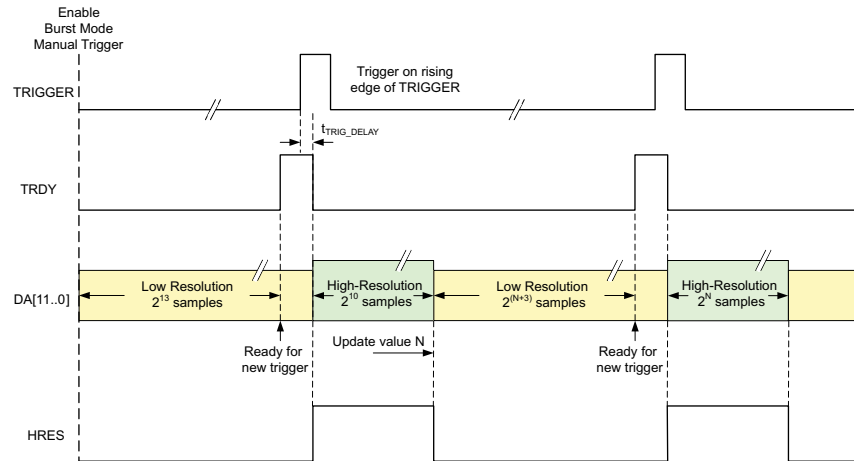
This mode is enabled by setting the auto trigger bit through a SPI register write and the DA data outputs start in low resolution for  $2^{13}$  samples. Immediately following completion of transmission of the last low resolution sample, the outputs automatically start transmitting  $2^{10}$  high-resolution samples without the need for external trigger ensuring maximum efficiency. Any input signal on the TRIGGER pins is ignored and the TRDY flag will go high only for one clock cycle with the start of the high-resolution data.

The output flag HRES is aligned with the  $2^N$  high-resolution output samples and the parameter N can be changed until the next output cycle starts again with low-resolution output data.



图 8-18. Auto Trigger Mode Timing Diagram

## 8.5 Programming

The serial interface (SIF) included in the ADS54T01 is a simple 3 or 4 pin interface. In normal mode, 3 pins are used to communicate with the device. There is an enable (SDENB), a clock (SCLK) and a bidirectional IO port (SDIO). If the user would like to use the 4-pin interface one write must be implemented in the 3-pin mode to enable 4-pin communications. In this mode, the SDO pin becomes the dedicated output. The serial interface has an 8-bit address word and a 16-bit data word. The first rising edge of SCLK after SDENB goes low will latch the read/write bit. If a high is registered, then a read is requested. If it is low, then a write is requested. SDENB must be brought high again before another transfer can be requested. The signal diagram is shown below:

### 8.5.1 Device Initialization

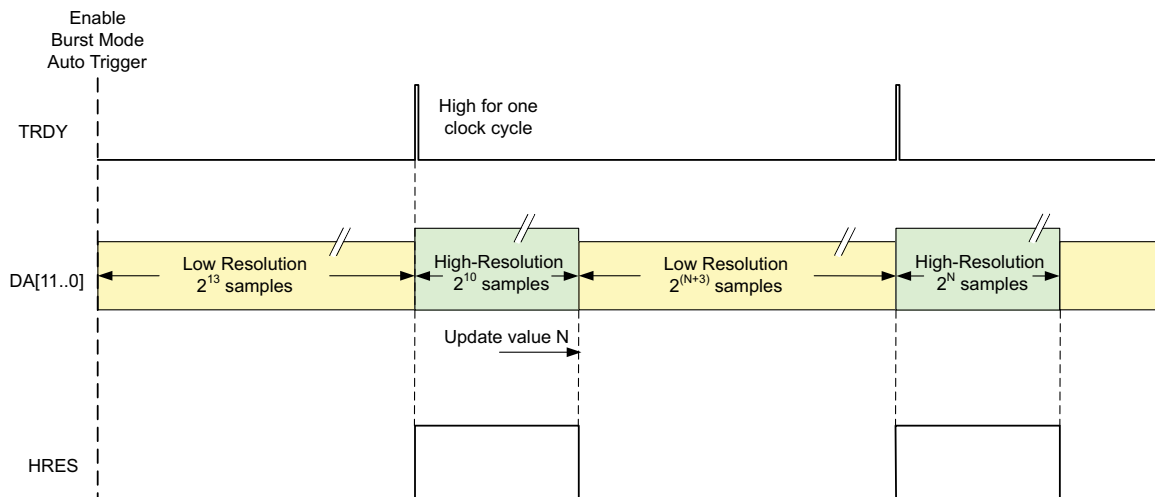
After power up, TI recommends to initialize the device through a hardware reset by applying a logic low pulse on the SRESETb pin (of width greater than 20 ns), as shown in [图 8-19](#). This resets all internal digital blocks (including SPI registers) to their default condition.



图 8-19. Device Initialization Timing Diagram

表 8-5. Reset Timing

PARAMETER		CONDITIONS	MIN	TYP	MAX	UNIT
$t_1$	Power-on delay	Delay from power up to active low RESET pulse	3			ms
$t_2$	Reset pulse width	Active low RESET pulse width	20			ns
$t_3$	Register write delay	Delay from RESET disable to SDENb active	100			ns

Recommended Device Initialization Sequence:

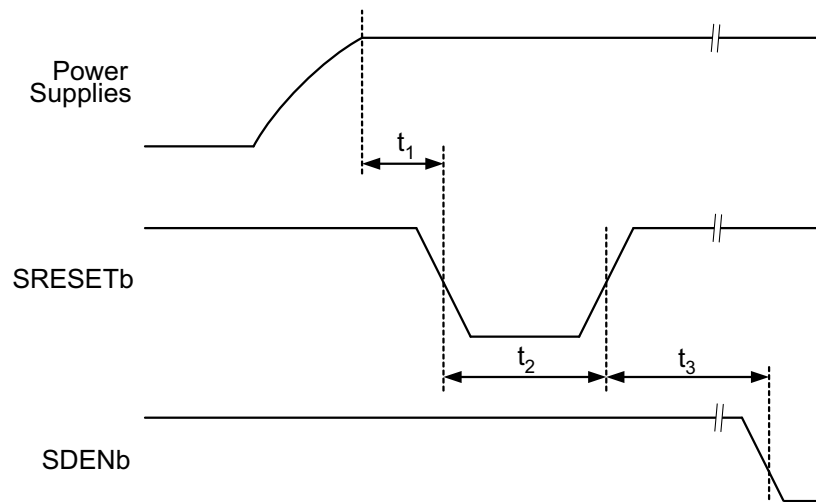
1. Power up
2. Reset ADS54T01 using hardware reset.
3. Apply clock and input signal.
4. Set register 0x01 bit D15 to "1" (ChA Corr EN) to enable gain/offset correction circuit and other desired registers.
5. Set register 0x03 bit D14 to "1" (Start Auto Corr ChA). This clears and resets the accumulator values in the DC and gain correction loop.
6. Set register 0x03 bit D14 to "0" (Start Auto Corr ChA). This starts the DC and gain auto-correction loop.

### 8.5.2 Serial Register Write

The internal register of the ADS54T01 can be programmed following these steps:

1. Drive SDENB pin low
2. Set the R/W bit to "0" (bit A7 of the 8-bit address)



- Initiate a serial interface cycle specifying the address of the register (A6 to A0) whose content has to be written
- Write 16-bit data which is latched on the rising edge of SCLK



图 8-20. Serial Register Write Timing Diagram

表 8-6. Timing Requirements

PARAMETER		MIN	TYP <sup>(1)</sup>	MAX	UNIT
f <sub>SCLK</sub>	SCLK frequency (equal to 1/t <sub>SCLK</sub> )	>DC		20	MHz
t <sub>SLOADS</sub>	SDENB to SCLK setup time	25			ns
t <sub>SLOADH</sub>	SCLK to SDENB hold time	25			ns
t <sub>DSU</sub>	SDIO setup time	25			ns
t <sub>DH</sub>	SDIO hold time	25			ns

(1) Typical values at +25°C; minimum and maximum values across the full temperature range: TMIN = -40°C to TMAX = +85°C, AVDD3V = 3.3 V, AVDD, DRVDD = 1.9 V, unless otherwise noted.

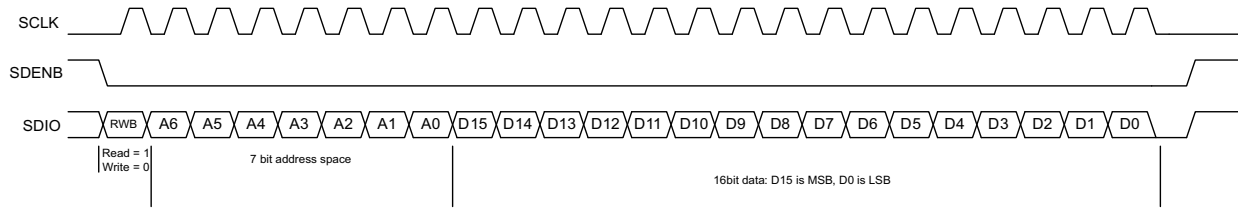
### 8.5.3 Serial Register Readout

The device includes a mode where the contents of the internal registers can be read back using the SDO/SDIO pins. This read-back mode may be useful as a diagnostic check to verify the serial interface communication between the external controller and the ADC.

- Drive SDENB pin low
- Set the RW bit (A7) to "1". This setting disables any further writes to the registers
- Initiate a serial interface cycle specifying the address of the register (A6 to A0) whose content has to be read.
- The device outputs the contents (D15 to D0) of the selected register on the SDO/SDIO pin
- The external controller can latch the contents at the SCLK rising edge.
- To enable register writes, reset the RW register bit to "0".



图 8-21. Serial Register Read Timing Diagram

## 8.6 Register Maps

### 8.6.1 Serial Register Map

表 8-7. Serial Registers

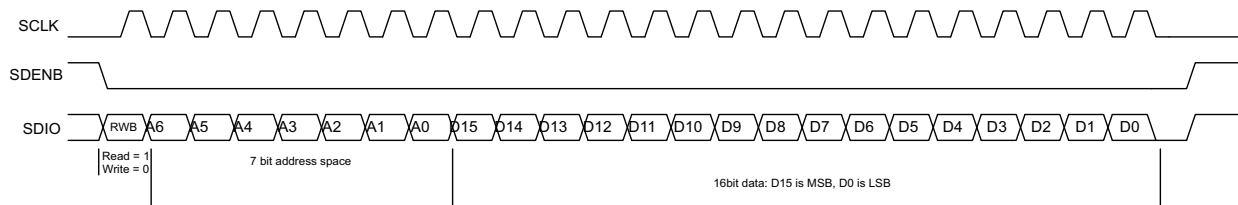
Register Address	Register Data <sup>(1)</sup>																
A7 - A0 IN HEX	D15	D14	D13	D12	D11	D10	D9	D8	D7	D6	D5	D4	D3	D2	D1	D0	
0	3/4 Wire SPI	DecFil/ Burst	0	High/ Low Pass	0	0	0	0	0	0	Burst rate	0	0	Auto Trigger	0	0	
1	Corr EN	0	0	0	0	0	0	0	0	0	0	0	Data Format	0	Hp Mode1	0	
2	0	1	1	0	0	Over-range threshold				0	0	0	0	0	0	0	
3	0	DC Offset Corr	0	0	1	0	1	1	0	0	0	1	1	0	0	0	
E	Sync Select														0	0	
F	Sync Select				0	0	0	0	0	VREF Set			0	0	0	0	
1A	0	0	0	0	1	0	1	1	0	0	0	1	1	0	0	0	
2B	0	0	0	0	0	0	0	Temp Sensor									
2C	Reset																
34	0	0	Burst Mode N				0	0	0	0	0	0	0	0	0	0	0
37	Sleep Modes						0	0	0	0	0	0	0	0	0	0	
38	HP Mode2							LP Mode	TEMP EN	BIAS EN	SYNC EN	TRIGEN	1	1	1	1	
3A	LVDS Current Strength			LVDS SW		Internal LVDS Termination		0	0	0	0	DACLK EN	DBCLK EN	0	OVRA EN	OVRB EN	
66	LVDS Output Bus A EN																

(1) Multiple functions in a register can be programmed in a single write operation.

### 8.6.2 Description of Serial Interface Registers

Register Address	Register Data															
A7-A0 in hex	D15	D14	D13	D12	D11	D10	D9	D8	D7	D6	D5	D4	D3	D2	D1	D0
0	3/4 Wire SPI	Dec Fil/ Burst	0	High/ Low Pass	0	0	0	0	0	0	Burst rate	0	0	Auto Trigger	0	0

- D15     **3/4 Wire SPI**                      Enables 4-bit serial interface when set  
Default 0
- 0         3-wire SPI is used with SDIO pin operating as bidirectional I/O port
- 1         4-wire SPI is used with SDIO pin operating as data input and SDO pin as data output port.
- D14     **DecFil/ Burst**                      2x decimation filter (Receive Mode) is enabled when bit is set  
Default 0
- 0         Burst mode enable
- 1         2x decimation filter enabled
- D12     **High/Low Pass**                      (Decimation filter must be enabled first: set bit D14)  
Default 0
- 0         Low Pass
- 1         High Pass
- D5       **Burst Rate**                              Low resolution output data rate in burst mode  
Default 0
- 0         Low resolution (9-bit) full output rate
- 1         Decimated low resolution output (4x decimation, 11-bit resolution)
- D2       **Auto Trigger**                            Enables auto trigger mode in burst mode without the need to control the trigger pin.  
Default 0
- 0         Manual trigger mode using the external trigger input pin
- 1         Auto trigger mode enabled

Register Address	Register Data															
A7-A0 in hex	D15	D14	D13	D12	D11	D10	D9	D8	D7	D6	D5	D4	D3	D2	D1	D0
1	Corr EN	0	0	0	0	0	0	0	0	0	0	0	Data Format	0	HP Mode1	0

**D15 Corr EN (should be enabled for maximum performance)**  
Default 0

- 0 auto gain correction disabled
- 1 auto gain correction enabled

**D3 Data Format**  
Default 0

- 0 Two's complement
- 1 Offset Binary

**D1 HP Mode 1**  
Default 0

- 1 Must be set to 1 for optimum performance

Register Address	Register Data															
A7-A0 in hex	D15	D14	D13	D12	D11	D10	D9	D8	D7	D6	D5	D4	D3	D2	D1	D0
2	0	1	1	0	0	Over-range threshold			0	0	0	0	0	0	0	0

**D14** Read back 1.

**D13** Read back 1.

**D10-D7 Over-range threshold**

The over-range detection is triggered 12 output clock cycles after the overload condition occurs. The threshold at which the OVR is triggered =  $1.0V \times [\text{decimal value of } \langle \text{Over-range threshold} \rangle / 16]$ . After power up or reset, the default value is 15 (decimal) which corresponds to a OVR threshold of 0.56dB below fullscale ( $20 \cdot \log(15/16)$ ). This OVR threshold is applicable to both channels.

Default 1111

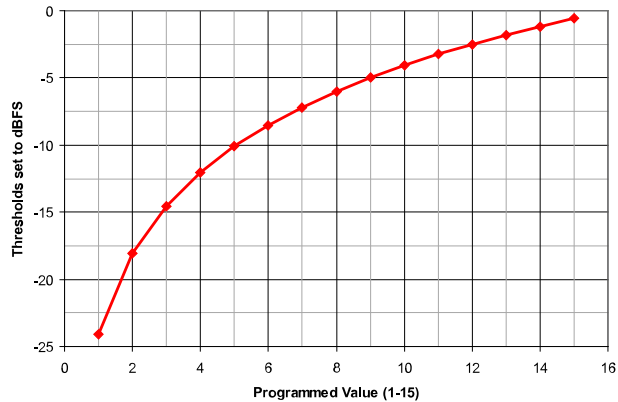

**图 8-22. Over-range Threshold vs. Programmed Value**

Register Address	Register Data															
A7-A0 in hex	D15	D14	D13	D12	D11	D10	D9	D8	D7	D6	D5	D4	D3	D2	D1	D0
3	0	DC Offset Coff	0	0	1	0	1	1	0	0	0	1	1	0	0	0

**D14 DC Offset Corr** Starts DC offset correction loop  
Default 1

- 0 Starts offset correction loop
- 1 DC offset correction loop is cleared

**D11, 9, 8, 4, 3** Must be set to 1 for maximum performance  
Default 1

Register Address	Register Data															
A7-A0 in hex	D15	D14	D13	D12	D11	D10	D9	D8	D7	D6	D5	D4	D3	D2	D1	D0
E	Sync Select														0	0

D15-D2      **Sync Select**      Sync selection for the clock generator block (also need to see address  
 Default 1010 1010 1010 10      0x0F)

0000 0000 0000 00      Sync is disabled

0101 0101 0101 01      Sync is set to one shot (one time synchronization only)

1010 1010 1010 10      Sync is derived from SYNC input pins

1111 1111 1111 11      not supported

Register Address	Register Data															
A7-A0 in hex	D15	D14	D13	D12	D11	D10	D9	D8	D7	D6	D5	D4	D3	D2	D1	D0
F	Sync Select				0	0	0	0	0	VREF Sel			0	0	0	0

D15-D12      **Sync Select**      Sync selection for the clock generator block  
 Default 1010 1010 1010 10

0000      Sync is disabled

0101      Sync is set to one shot (one time synchronization only)

1010      Sync is derived from SYNC input pins

1111      not supported

D6-D4      **VREF SEL**      Internal voltage reference selection  
 Default 000

000      1.0 V

001      1.25 V

010      0.9 V

011      0.8 V

100      1.15 V

Others      external reference

Register Address	Register Data															
A7-A0 in hex	D15	D14	D13	D12	D11	D10	D9	D8	D7	D6	D5	D4	D3	D2	D1	D0
1A	0	0	0	0	1	0	1	1	0	0	0	1	1	0	0	0

D14, 11, 9, 8, 4, 3      Must be set to 1 for maximum performance  
 Default 1

Register Address	Register Data															
A7-A0 in hex	D15	D14	D13	D12	D11	D10	D9	D8	D7	D6	D5	D4	D3	D2	D1	D0
2B	0	0	0	0	0	0	0	Temp Sensor								

D8-D0      **Temp Sensor**      Internal temperature sensor value - read only

Register Address	Register Data															
A7-A0 in hex	D15	D14	D13	D12	D11	D10	D9	D8	D7	D6	D5	D4	D3	D2	D1	D0
2C	Reset															

D15-D0      **Reset**      This is a software reset to reset all SPI registers to their default value. Self clears to 0.  
 Default 0000

1101001011110000      Perform software reset

Register Address	Register Data																
A7-A0 in hex	D15	D14	D13	D12	D11	D10	D9	D8	D7	D6	D5	D4	D3	D2	D1	D0	
34	0	0	Burst Mode N				0	0	0	0	0	0	0	0	0	0	0

D13-D10     **Burst Mode N**     This is the parameter that sets the amount of high resolution samples in burst mode  
Default 0000

0000     N = 10

0001     N = 11

...     ...

1111     N = 25

Register Address	Register Data															
A7-A0 in hex	D15	D14	D13	D12	D11	D10	D9	D8	D7	D6	D5	D4	D3	D2	D1	D0
37	Sleep Modes							0	0	0	0	0	0	0	0	0

D15-D14     **Sleep Modes**     Sleep mode selection which is controlled by the ENABLE pin. Sleep modes are active when ENABLE pin goes low.  
Default 00

000000     Complete shut down     Wake up time 2.5 ms

100000     Standby mode     Wake up time 100  $\mu$ s

110000     Deep sleep mode     Wake up time 20  $\mu$ s

110101     Light sleep mode     Wake up time 2  $\mu$ s

Register Address	Register Data															
A7-A0 in hex	D15	D14	D13	D12	D11	D10	D9	D8	D7	D6	D5	D4	D3	D2	D1	D0
38	HP Mode 2							LP Mode	TEMP EN	FUSE Bias EN	SYNC EN	TRIG EN	1	1	1	1

D15-D9     **HP Mode 2**     Default 1111111111

1     Set to 1 for normal operation

D8     **LP Mode**     Low power mode  
Default 1

0     Set to 0 to turn off unused output buffers

D7     **TEMP EN**     Temperature sensor enable  
Default 1

1     Set to 1 to enable the temperature sensor

D6     **FUSE BIAS EN**     Enables internal bias voltages. Can be disabled after power up for power savings.  
Default 1

0     Internal fuse bias powered down

1     Internal fuse bias enabled

D5     **SYNC EN**     Enables the SYNC input buffer.  
Default 1

0     SYNC input buffer disabled

1     SYNC input bffer enabled

D4     **TRIG EN**     Enables the TRIGGER input buffer.  
Default 1

0     TRIGGER input buffer disabled

1     TRIGGER input bffer enabled

D3-D0     Read back 1

**ADS54T01**

ZHCSAM3B - DECEMBER 2012 - REVISED APRIL 2022

Register Address	Register Data															
A7-A0 in hex	D15	D14	D13	D12	D11	D10	D9	D8	D7	D6	D5	D4	D3	D2	D1	D0
3A	LVDS Current Strength			LVDS SW		Internal LVDS Termination		0	0	0	0	DACLK EN	0	0	OVRA EN	0

D15-D13	<b>LVDS Current Strength</b> Default 000	LVDS output current strength.	
000	2 mA	100	3 mA
001	2.25 mA	101	3.25 mA
010	2.5 mA	110	3.5 mA
011	2.75 mA	111	3.75 mA
D12-D11	<b>LVDS SW</b> Default 01	LVDS driver internal switch setting - correct range must be set for setting in D15-D13	
01	2 mA to 2.75 mA		
11	3mA to 3.75mA		
D10-D9	<b>Internal LVDS Termination</b> Default 00	Internal termination	
00	2 k $\Omega$		
01	200 $\Omega$		
10	200 $\Omega$		
11	100 $\Omega$		
D4	<b>DACLK EN</b> Default 1	Enable DACLK output buffer	
0	DACLK output buffer powered down		
1	DACLK output buffer enabled		
D1	<b>OVRA EN</b> Default 1	Enable OVRA output buffer	
0	OVRA output buffer powered down		
1	OVRA output buffer enabled		

Register Address	Register Data															
A7-A0 in hex	D15	D14	D13	D12	D11	D10	D9	D8	D7	D6	D5	D4	D3	D2	D1	D0
66	LVDS Output Bus EN															

D15-D0	<b>LVDS Output Bus EN</b> Default FFFF	Individual LVDS output pin power down	
0	Output is powered down		
1	Output is enabled		
D15	corresponds to TRDYP/N (pins N7, P7)		
D14	corresponds to HRESP/N (pins N6, P6)		
D13	SYNCOUTP/N (pins N5, P5)		
D12	Pins N4, P4 (no connect pins) which are not used and should be powered down for power savings		
D11-D0	corresponds to DA11-DA0		

## 9 Power Supply Recommendations

The device requires a 1.8-V nominal supply for AVDDC, AVDD18, DVDD, DVDDLVD, and IOVDD. The device also requires a 3.3-V supply for AVDD33. There are no specific sequence power-supply requirements during device power-up. AVDDC, AVDD18, DVDD, DVDDLVD, IOVDD and AVDD33 can power up in any order.

## 10 Device and Documentation Support

TI offers an extensive line of development tools. Tools and software to evaluate the performance of the device, generate code, and develop solutions are listed below.

### 10.1 接收文档更新通知

要接收文档更新通知，请导航至 [ti.com](http://ti.com) 上的器件产品文件夹。点击 [订阅更新](#) 进行注册，即可每周接收产品信息更改摘要。有关更改的详细信息，请查看任何已修订文档中包含的修订历史记录。

### 10.2 支持资源

TI E2E™ [支持论坛](#) 是工程师的重要参考资料，可直接从专家获得快速、经过验证的解答和设计帮助。搜索现有解答或提出自己的问题可获得所需的快速设计帮助。

链接的内容由各个贡献者“按原样”提供。这些内容并不构成 TI 技术规范，并且不一定反映 TI 的观点；请参阅 TI 的 [《使用条款》](#)。

### 10.3 Trademarks

TI E2E™ is a trademark of Texas Instruments.

所有商标均为其各自所有者的财产。

### 10.4 Electrostatic Discharge Caution



This integrated circuit can be damaged by ESD. Texas Instruments recommends that all integrated circuits be handled with appropriate precautions. Failure to observe proper handling and installation procedures can cause damage.

ESD damage can range from subtle performance degradation to complete device failure. Precision integrated circuits may be more susceptible to damage because very small parametric changes could cause the device not to meet its published specifications.

### 10.5 术语表

[TI 术语表](#) 本术语表列出并解释了术语、首字母缩略词和定义。

## 11 Mechanical, Packaging, and Orderable Information

The following pages include mechanical, packaging, and orderable information. This information is the most current data available for the designated devices. This data is subject to change without notice and revision of this document. For browser-based versions of this data sheet, refer to the left-hand navigation.



**PACKAGING INFORMATION**

Orderable Device	Status (1)	Package Type	Package Drawing	Pins	Package Qty	Eco Plan (2)	Lead finish/ Ball material (6)	MSL Peak Temp (3)	Op Temp (°C)	Device Marking (4/5)	Samples
ADS54T01IZAY	ACTIVE	NFBGA	ZAY	196	160	RoHS & Green	SNAGCU	Level-3-260C-168 HR	-40 to 85	ADS54T011	<a href="#">Samples</a>
ADS54T01IZAYR	ACTIVE	NFBGA	ZAY	196	1000	RoHS & Green	SNAGCU	Level-3-260C-168 HR	-40 to 85	ADS54T011	<a href="#">Samples</a>

(1) The marketing status values are defined as follows:

**ACTIVE:** Product device recommended for new designs.

**LIFEBUY:** TI has announced that the device will be discontinued, and a lifetime-buy period is in effect.

**NRND:** Not recommended for new designs. Device is in production to support existing customers, but TI does not recommend using this part in a new design.

**PREVIEW:** Device has been announced but is not in production. Samples may or may not be available.

**OBSOLETE:** TI has discontinued the production of the device.

(2) **RoHS:** TI defines "RoHS" to mean semiconductor products that are compliant with the current EU RoHS requirements for all 10 RoHS substances, including the requirement that RoHS substance do not exceed 0.1% by weight in homogeneous materials. Where designed to be soldered at high temperatures, "RoHS" products are suitable for use in specified lead-free processes. TI may reference these types of products as "Pb-Free".

**RoHS Exempt:** TI defines "RoHS Exempt" to mean products that contain lead but are compliant with EU RoHS pursuant to a specific EU RoHS exemption.

**Green:** TI defines "Green" to mean the content of Chlorine (Cl) and Bromine (Br) based flame retardants meet JS709B low halogen requirements of <=1000ppm threshold. Antimony trioxide based flame retardants must also meet the <=1000ppm threshold requirement.

(3) MSL, Peak Temp. - The Moisture Sensitivity Level rating according to the JEDEC industry standard classifications, and peak solder temperature.

(4) There may be additional marking, which relates to the logo, the lot trace code information, or the environmental category on the device.

(5) Multiple Device Markings will be inside parentheses. Only one Device Marking contained in parentheses and separated by a "~" will appear on a device. If a line is indented then it is a continuation of the previous line and the two combined represent the entire Device Marking for that device.

(6) Lead finish/Ball material - Orderable Devices may have multiple material finish options. Finish options are separated by a vertical ruled line. Lead finish/Ball material values may wrap to two lines if the finish value exceeds the maximum column width.

**Important Information and Disclaimer:**The information provided on this page represents TI's knowledge and belief as of the date that it is provided. TI bases its knowledge and belief on information provided by third parties, and makes no representation or warranty as to the accuracy of such information. Efforts are underway to better integrate information from third parties. TI has taken and continues to take reasonable steps to provide representative and accurate information but may not have conducted destructive testing or chemical analysis on incoming materials and chemicals. TI and TI suppliers consider certain information to be proprietary, and thus CAS numbers and other limited information may not be available for release.

In no event shall TI's liability arising out of such information exceed the total purchase price of the TI part(s) at issue in this document sold by TI to Customer on an annual basis.



**TAPE AND REEL INFORMATION**

**QUADRANT ASSIGNMENTS FOR PIN 1 ORIENTATION IN TAPE**

\*All dimensions are nominal

Device	Package Type	Package Drawing	Pins	SPQ	Reel Diameter (mm)	Reel Width W1 (mm)	A0 (mm)	B0 (mm)	K0 (mm)	P1 (mm)	W (mm)	Pin1 Quadrant
ADS54T01IZAYR	NFBGA	ZAY	196	1000	330.0	24.4	12.3	12.3	2.3	16.0	24.0	Q1

**TAPE AND REEL BOX DIMENSIONS**

\*All dimensions are nominal

Device	Package Type	Package Drawing	Pins	SPQ	Length (mm)	Width (mm)	Height (mm)
ADS54T01IZAYR	NFBGA	ZAY	196	1000	350.0	350.0	43.0

**TRAY**

Chamfer on Tray corner indicates Pin 1 orientation of packed units.

\*All dimensions are nominal

Device	Package Name	Package Type	Pins	SPQ	Unit array matrix	Max temperature (°C)	L (mm)	W (mm)	K0 (µm)	P1 (mm)	CL (mm)	CW (mm)
ADS54T01IZAY	ZAY	NFBGA	196	160	8 x 20	150	315	135.9	7620	15.4	11.2	19.65

# ZAY0196A

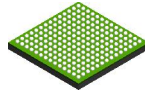

# PACKAGE OUTLINE

## NFBGA - 1.4 mm max height

PLASTIC BALL GRID ARRAY

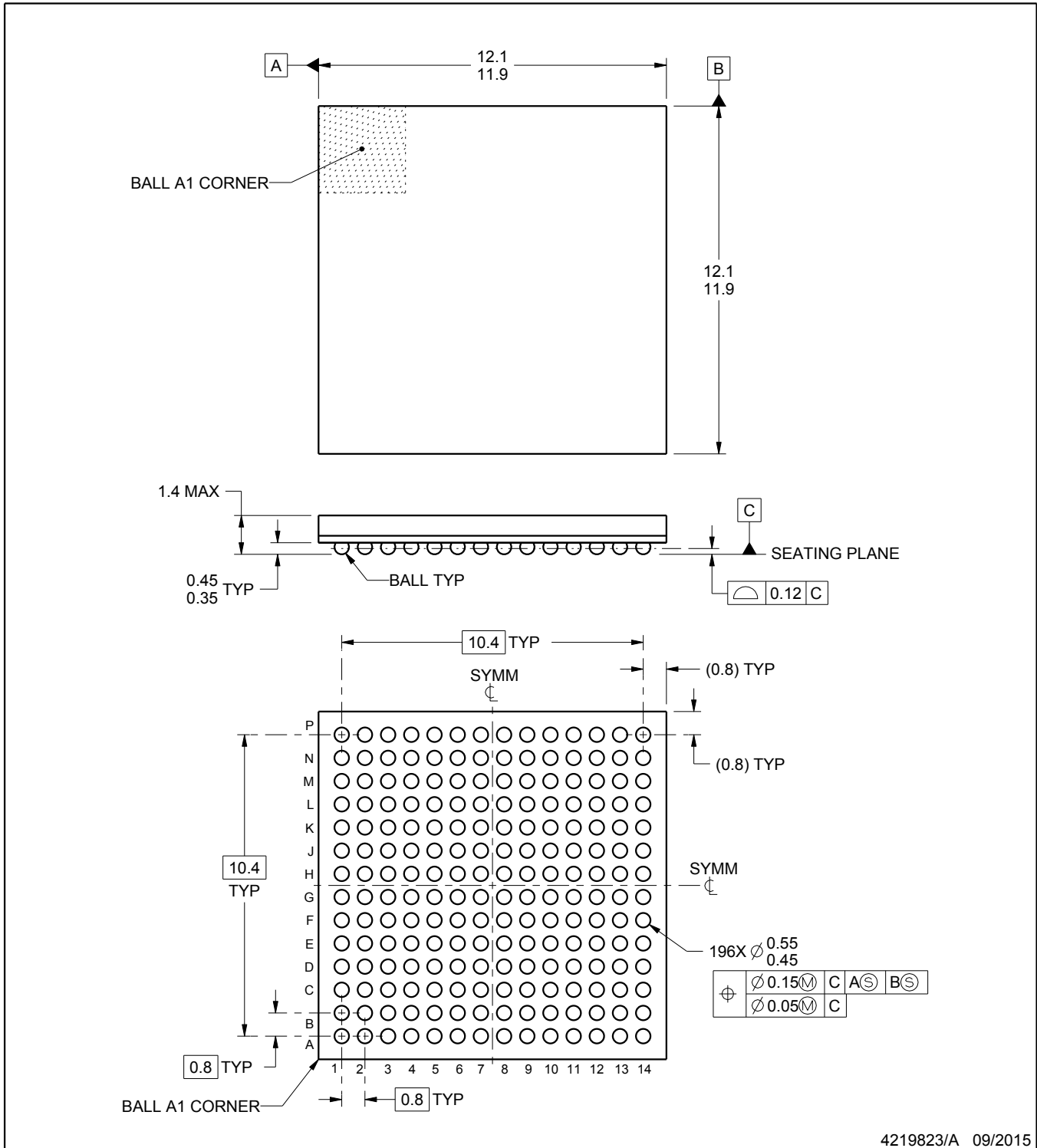

4219823/A 09/2015

**NOTES:**

1. All linear dimensions are in millimeters. Any dimensions in parenthesis are for reference only. Dimensioning and tolerancing per ASME Y14.5M.
2. This drawing is subject to change without notice.

# EXAMPLE BOARD LAYOUT

ZAY0196A

NFBGA - 1.4 mm max height

PLASTIC BALL GRID ARRAY

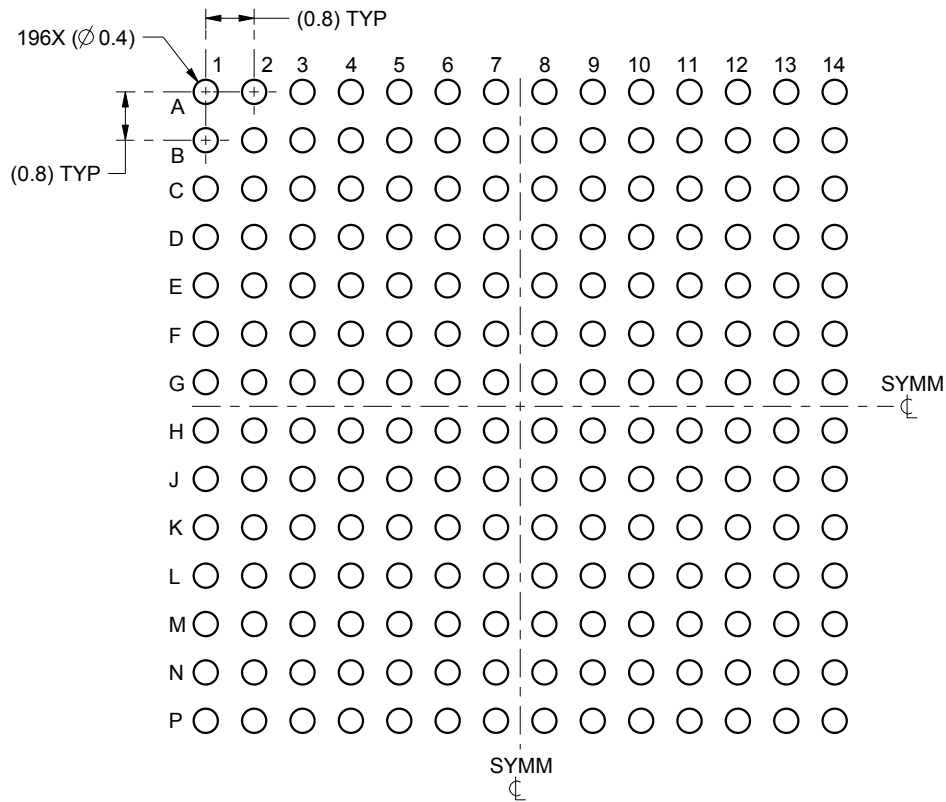

LAND PATTERN EXAMPLE  
SCALE:8X

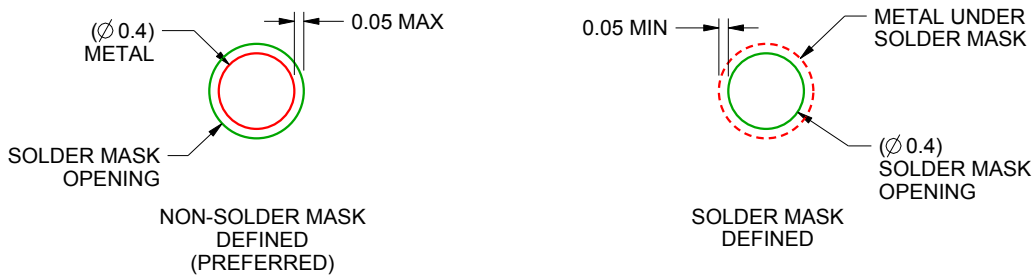

SOLDER MASK DETAILS  
NOT TO SCALE

4219823/A 09/2015

NOTES: (continued)

- Final dimensions may vary due to manufacturing tolerance considerations and also routing constraints. For information, see Texas Instruments literature number SPRAA99 ([www.ti.com/lit/spraa99](http://www.ti.com/lit/spraa99)).

# EXAMPLE STENCIL DESIGN

ZAY0196A

NFBGA - 1.4 mm max height

PLASTIC BALL GRID ARRAY

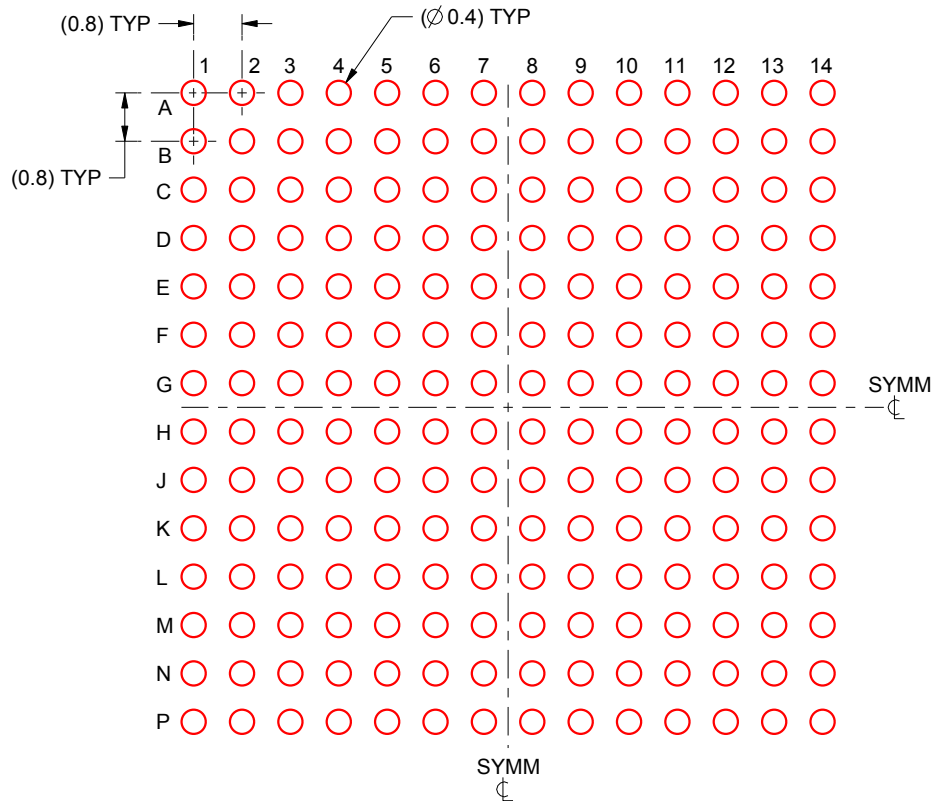

SOLDER PASTE EXAMPLE  
BASED ON 0.15 mm THICK STENCIL  
SCALE:8X

4219823/A 09/2015

NOTES: (continued)

4. Laser cutting apertures with trapezoidal walls and rounded corners may offer better paste release.



## 重要声明和免责声明

TI“按原样”提供技术和可靠性数据（包括数据表）、设计资源（包括参考设计）、应用或其他设计建议、网络工具、安全信息和其他资源，不保证没有瑕疵且不做任何明示或暗示的担保，包括但不限于对适销性、某特定用途方面的适用性或不侵犯任何第三方知识产权的暗示担保。

这些资源可供使用 TI 产品进行设计的熟练开发人员使用。您将自行承担以下全部责任：(1) 针对您的应用选择合适的 TI 产品，(2) 设计、验证并测试您的应用，(3) 确保您的应用满足相应标准以及任何其他功能安全、信息安全、监管或其他要求。

这些资源如有变更，恕不另行通知。TI 授权您仅可将这些资源用于研发本资源所述的 TI 产品的应用。严禁对这些资源进行其他复制或展示。您无权使用任何其他 TI 知识产权或任何第三方知识产权。您应全额赔偿因在这些资源的使用中对 TI 及其代表造成的任何索赔、损害、成本、损失和债务，TI 对此概不负责。

TI 提供的产品受 [TI 的销售条款](#) 或 [ti.com](#) 上其他适用条款/TI 产品随附的其他适用条款的约束。TI 提供这些资源并不会扩展或以其他方式更改 TI 针对 TI 产品发布的适用的担保或担保免责声明。

TI 反对并拒绝您可能提出的任何其他或不同的条款。

邮寄地址：Texas Instruments, Post Office Box 655303, Dallas, Texas 75265

Copyright © 2022，德州仪器 (TI) 公司