



# OPA4243



For most current data sheet and other product information, visit [www.burr-brown.com](http://www.burr-brown.com)

## Quad OPERATIONAL AMPLIFIER *MicroPOWER, Single-Supply*

### FEATURES

- MICRO-SIZE, TSSOP PACKAGE
- SINGLE-SUPPLY OPERATION
- WIDE SUPPLY RANGE: 2.2V to 36V
- LOW QUIESCENT CURRENT: 45 $\mu$ A/chan
- WIDE BANDWIDTH: 430kHz
- WIDE INPUT/OUTPUT SWING

### APPLICATIONS

- LCD DISPLAY DRIVERS
- BATTERY POWERED SYSTEMS
- PORTABLE EQUIPMENT
- PCMCIA CARDS
- BATTERY PACKS AND POWER SUPPLIES
- CONSUMER PRODUCTS

### DESCRIPTION

The OPA4243 is a four-channel op amp specifically designed for high density, space-limited applications, such as LCD bias drivers, PCMCIA cards, battery-packs and portable instruments. In addition to small size, this part features wide output swing, very low quiescent current, and low bias current. Other features include unity gain stability and the best speed power ratio available. Power supplies in the range of 2.2V to 36V ( $\pm 1.1V$  to  $\pm 18V$ ) can be used.

Each channel uses completely independent circuitry for lowest crosstalk and freedom from interaction, even when overloaded. In addition, the amplifier is free from output inversion when the inputs are driven to the rail. The OPA4243EA is supplied in the miniature TSSOP-14 surface mount package. Specifications apply from  $-40^{\circ}C$  to  $+85^{\circ}C$ . However, as the extensive typical performance curves indicate, the OPA4243 can be used over the full  $-55^{\circ}C$  to  $+125^{\circ}C$  range. A SPICE macromodel is available for design analysis.

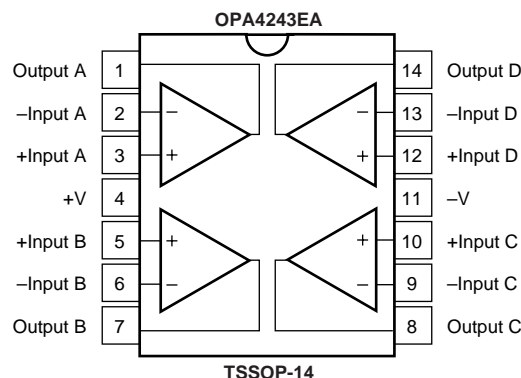

International Airport Industrial Park • Mailing Address: PO Box 11400, Tucson, AZ 85734 • Street Address: 6730 S. Tucson Blvd., Tucson, AZ 85706 • Tel: (520) 746-1111  
Twx: 910-952-1111 • Internet: <http://www.burr-brown.com/> • Cable: BBRCORP • Telex: 066-6491 • FAX: (520) 889-1510 • Immediate Product Info: (800) 548-6132

# SPECIFICATIONS: $V_S = +2.6V$ to $+36V$

**Boldface** limits apply over the specified temperature range,  $T_A = -40^\circ\text{C}$  to  $+85^\circ\text{C}$

At  $T_A = +25^\circ\text{C}$ ,  $R_L = 20\text{k}\Omega$  connected to ground, unless otherwise noted.

PARAMETER	CONDITIONS	OPA4243EA			UNITS
		MIN	TYP <sup>(1)</sup>	MAX	
<b>OFFSET VOLTAGE</b>					
Input Offset Voltage <b>Over Temperature</b>	$V_{OS} = \pm 7.5V, V_{CM} = 0$		$\pm 2$	$\pm 5$	mV
vs Temperature	$T_A = -40^\circ\text{C}$ to $+85^\circ\text{C}$		$\pm 2.5$	$\pm 6$	mV
vs Power Supply	$V_S = +2.6V$ to $+36V$		2.5	100	$\mu\text{V}/^\circ\text{C}$
<b>Over Temperature</b>	$V_S = +2.6V$ to $+36V$			<b>100</b>	$\mu\text{V}/V$
Channel Separation			140		dB
<b>INPUT BIAS CURRENT</b>					
Input Bias Current	$V_{CM} = V_S/2$		-10	-25	nA
Input Offset Current	$V_{CM} = V_S/2$		$\pm 1$	$\pm 10$	nA
<b>NOISE</b>					
Input Noise Voltage, $f = 0.1$ to $10\text{Hz}$			0.4		$\mu\text{Vp-p}$
Input Noise Voltage Density, $f = 1\text{kHz}$			22		$\text{nV}/\sqrt{\text{Hz}}$
Current Noise Density, $f = 1\text{kHz}$			40		$\text{fA}/\sqrt{\text{Hz}}$
<b>INPUT VOLTAGE RANGE</b>					
Common-Mode Voltage Range	$V_{CM}$	0		$(V+) - 0.9$	V
Common-Mode Rejection	CMRR	82	104		dB
<b>Over Temperature</b>	$V_S = \pm 18V, V_{CM} = -18V$ to $+17.1V$ $V_S = \pm 18V, V_{CM} = -18V$ to $+17.1V$	<b>82</b>			dB
<b>INPUT IMPEDANCE</b>					
Differential			$10^6 \parallel 2$		$\Omega \parallel \text{pF}$
Common-Mode			$10^9 \parallel 2$		$\Omega \parallel \text{pF}$
<b>OPEN-LOOP GAIN</b>					
Open-Loop Voltage Gain	$V_O = 0.5V$ to $(V+) - 0.9$	86	104		dB
<b>Over Temperature</b>	$V_O = 0.5V$ to $(V+) - 0.9$	<b>86</b>			dB
<b>FREQUENCY RESPONSE</b>					
Gain-Bandwidth Product	GBW		430		kHz
Slew Rate	SR		$-0.1, \pm 0.16$		$\text{V}/\mu\text{s}$
Setting Time, 0.01%			150		$\mu\text{s}$
Overload Recovery Time	$V_{IN} \bullet \text{Gain} = V_S$		8		$\mu\text{s}$
<b>OUTPUT</b>					
Voltage Output, Positive	$V_O$	$A_{OL} \geq 80\text{dB}, R_L = 20\text{k}\Omega$ to $V_S/2$	$(V+) - 0.9$	$(V+) - 0.75$	V
<b>Over Temperature</b>		$A_{OL} \geq 80\text{dB}, R_L = 20\text{k}\Omega$ to $V_S/2$	<b><math>(V+) - 0.9</math></b>	$(V+) - 0.75$	V
Voltage Output, Negative		$A_{OL} \geq 80\text{dB}, R_L = 20\text{k}\Omega$ to $V_S/2$	0.5	0.2	V
<b>Over Temperature</b>		$A_{OL} \geq 80\text{dB}, R_L = 20\text{k}\Omega$ to $V_S/2$	<b>0.5</b>	<b>0.2</b>	V
Voltage Output, Positive		$A_{OL} \geq 80\text{dB}, R_L = 20\text{k}\Omega$ to Ground		$(V+) - 0.75$	V
<b>Over Temperature</b>		$A_{OL} \geq 80\text{dB}, R_L = 20\text{k}\Omega$ to Ground		$(V+) - 0.75$	V
Voltage Output, Negative		$A_{OL} \geq 80\text{dB}, R_L = 20\text{k}\Omega$ to Ground		0.1	V
<b>Over Temperature</b>		$A_{OL} \geq 80\text{dB}, R_L = 20\text{k}\Omega$ to Ground		0.1	V
Short-Circuit Current	$I_{SC}$			-25, +12	mA
Capacitive Load Drive	$C_{LOAD}$			See Typical Curve	
<b>POWER SUPPLY</b>					
Specified Voltage Range	$V_S$	<b>Over Temperature</b>	<b>+2.6</b>		V
Minimum Operating Voltage				+2.2	V
Quiescent Current	$I_O$	$I_O = 0$		45	$\mu\text{A}$
<b>Over Temperature</b>		$I_O = 0$		<b>60</b>	$\mu\text{A}$
<b>TEMPERATURE RANGE</b>					
Specified Range			-40	85	$^\circ\text{C}$
Operating Range			-55	125	$^\circ\text{C}$
Storage Range			-65	150	$^\circ\text{C}$
Thermal Resistance	$\theta_{JA}$				
TSSOP-14 Surface Mount				100	$^\circ\text{C}/\text{W}$

NOTE: (1)  $V_S = +15V$ .

## ABSOLUTE MAXIMUM RATINGS<sup>(1)</sup>

Supply Voltage, V+ to V- .....	36V
Input Voltage Range <sup>(2)</sup> .....	(V-) - 0.3V to (V+) + 0.3V
Input Current <sup>(2)</sup> .....	10mA
Output Short-Circuit <sup>(3)</sup> .....	Continuous
Operating Temperature .....	-55°C to +125°C
Storage Temperature .....	-65°C to +150°C
Junction Temperature .....	150°C
Lead Temperature (soldering, 10s) .....	300°C
ESD Capability .....	2000V

NOTES: (1) Stresses above these ratings may cause permanent damage. Exposure to absolute maximum conditions for extended periods may degrade device reliability. (2) Inputs are diode-clamped to the supply rails and should be current-limited to 10mA or less if input voltages can exceed rails by more than 0.3V. (3) Short-circuit to ground, one amplifier per package.



## ELECTROSTATIC DISCHARGE SENSITIVITY

This integrated circuit can be damaged by ESD. Burr-Brown recommends that all integrated circuits be handled with appropriate precautions. Failure to observe proper handling and installation procedures can cause damage.

ESD damage can range from subtle performance degradation to complete device failure. Precision integrated circuits may be more susceptible to damage because very small parametric changes could cause the device not to meet its published specifications.

## PACKAGE/ORDERING INFORMATION

PRODUCT	PACKAGE	PACKAGE DRAWING NUMBER	SPECIFIED TEMPERATURE RANGE	PACKAGE MARKING	ORDERING NUMBER <sup>(1)</sup>	TRANSPORT MEDIA
OPA4243EA "	TSSOP-14 "	357 "	-40°C to +85°C "	OPA4243EA "	OPA4243EA/250 OPA4243EA/2K5	Tape and Reel Tape and Reel

NOTE: (1) Models with a slash (/) are available only in Tape and Reel in the quantities indicated (e.g., /2K5 indicates 2500 devices per reel). Ordering 2500 pieces of "OPA4243EA" will get a single 2500-piece Tape and Reel.

# TYPICAL PERFORMANCE CURVES

At  $T_A = +25^\circ\text{C}$ ,  $R_L = 20\text{k}\Omega$  connected to ground, unless otherwise noted.

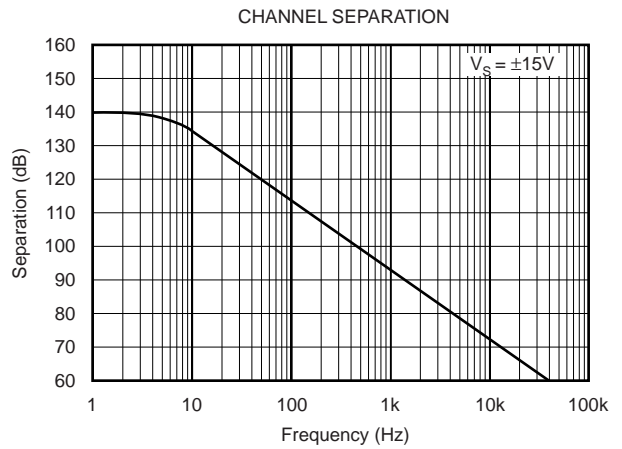
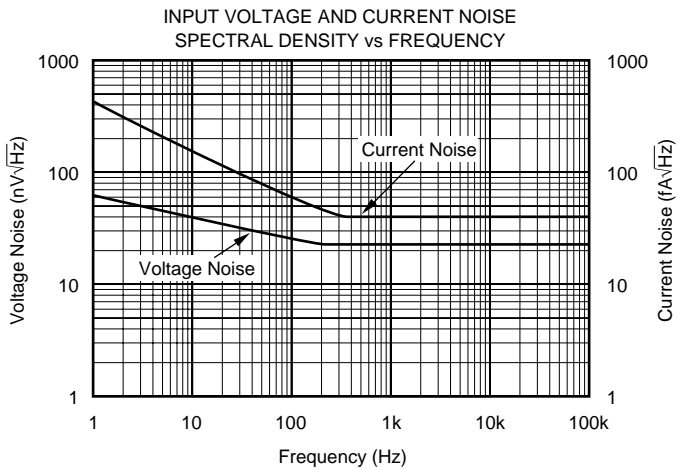
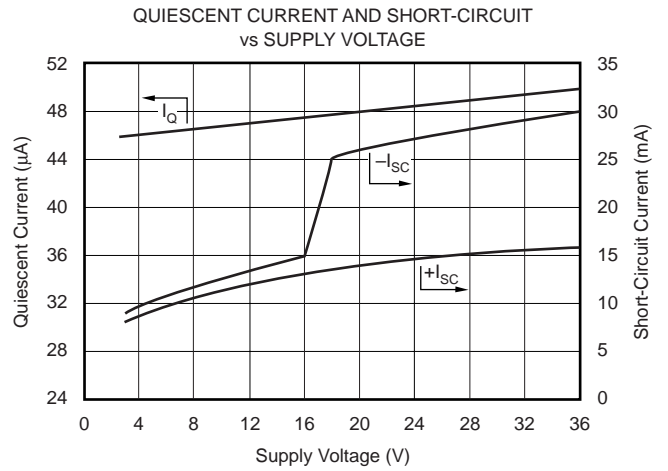
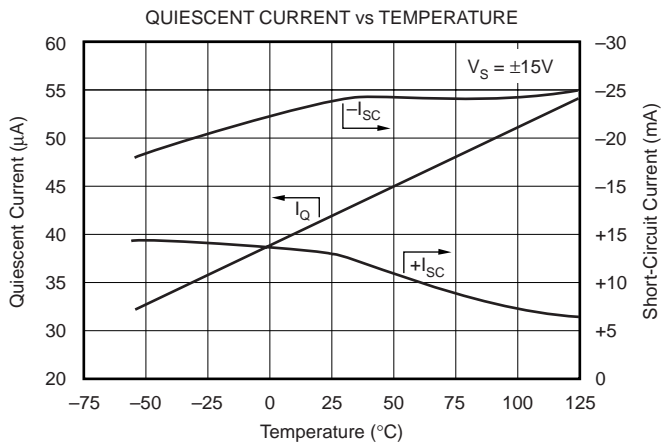
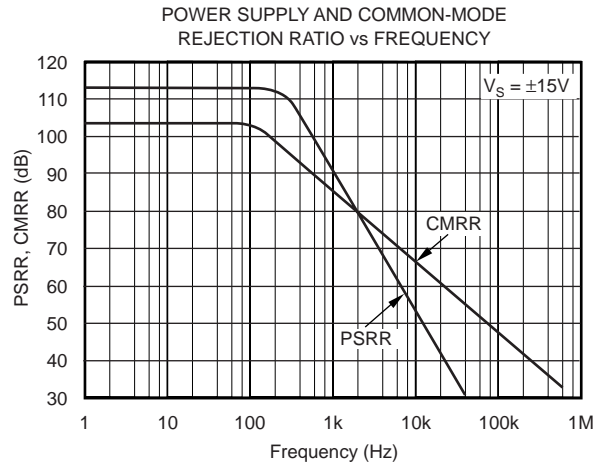
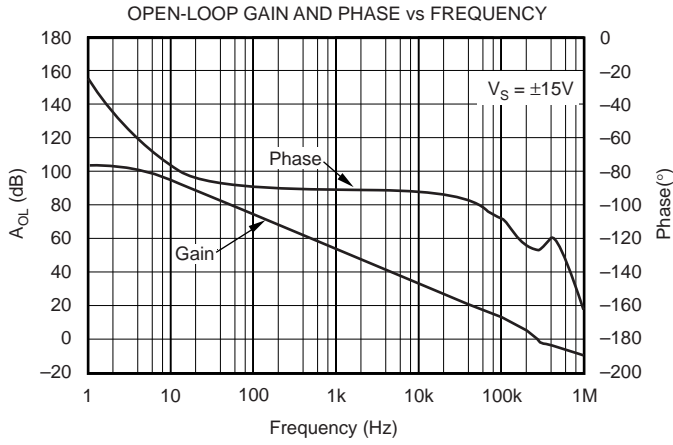

# TYPICAL PERFORMANCE CURVES (Cont.)

At  $T_A = +25^\circ\text{C}$ ,  $R_L = 20\text{k}\Omega$  connected to ground, unless otherwise noted.

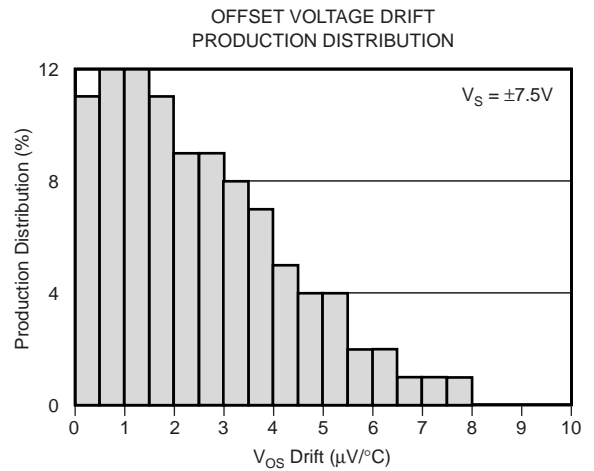
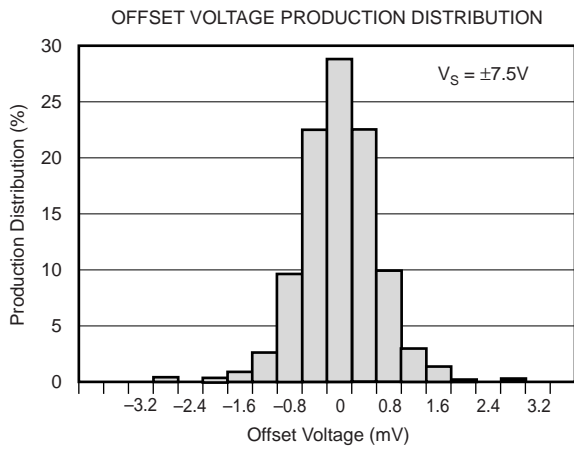
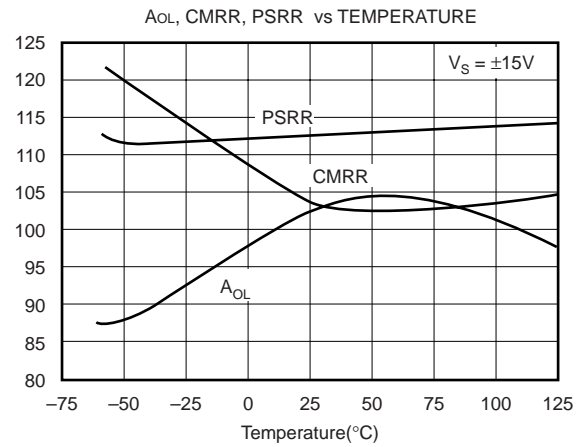
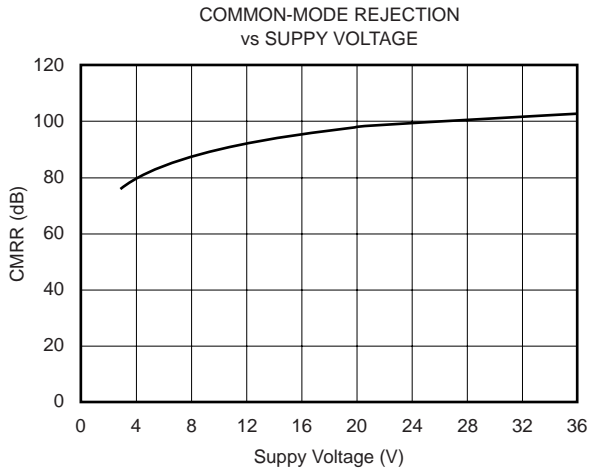
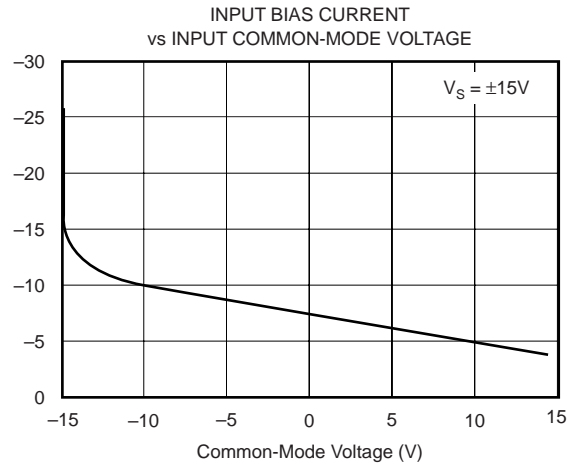
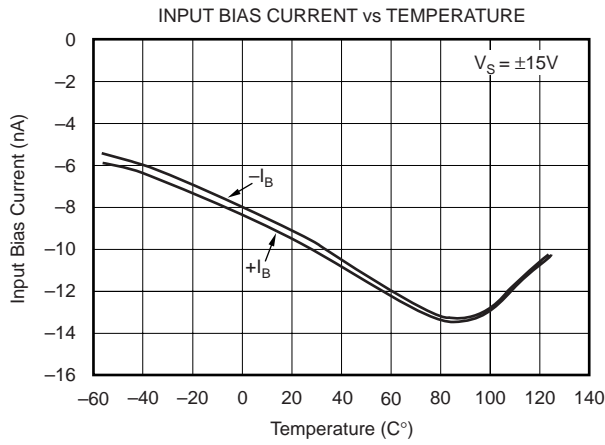

# TYPICAL PERFORMANCE CURVES (Cont.)

At  $T_A = +25^\circ\text{C}$ ,  $R_L = 20\text{k}\Omega$  connected to ground, unless otherwise noted.

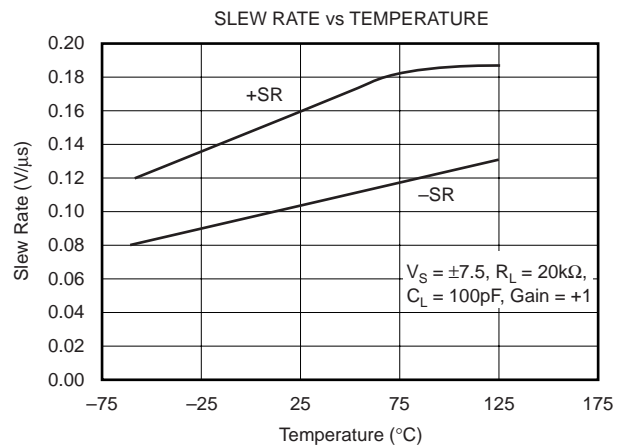
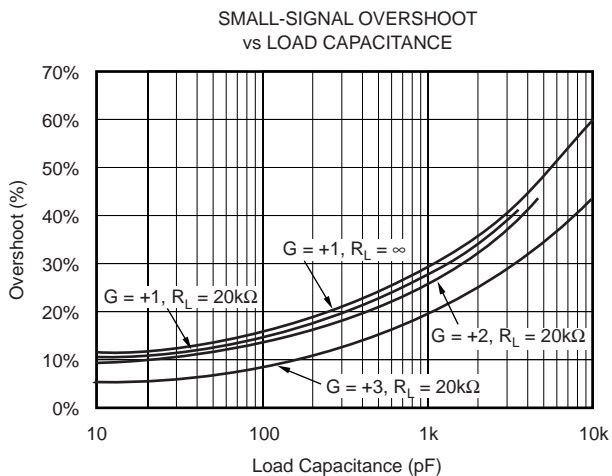
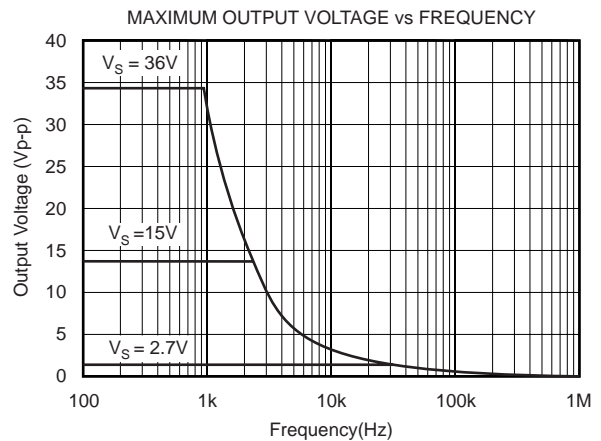
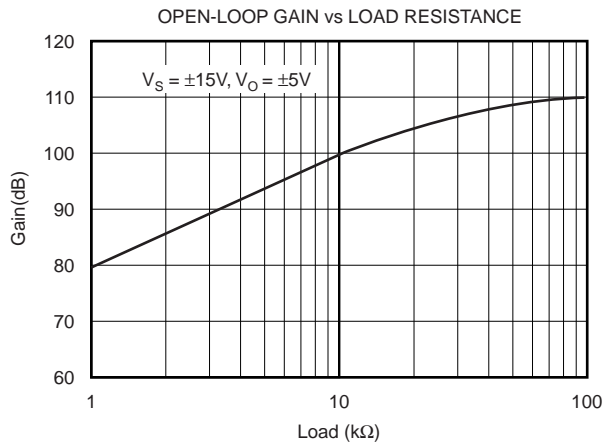
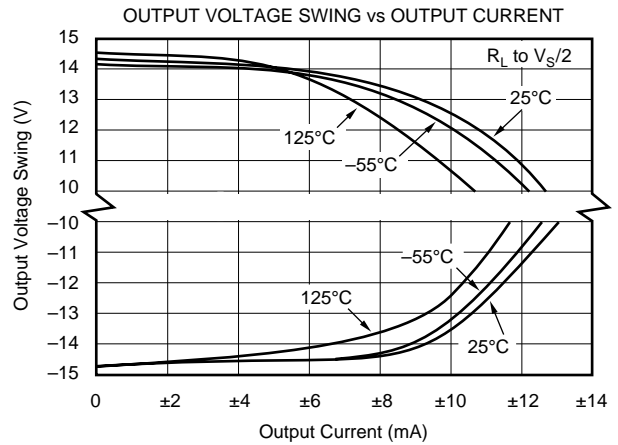
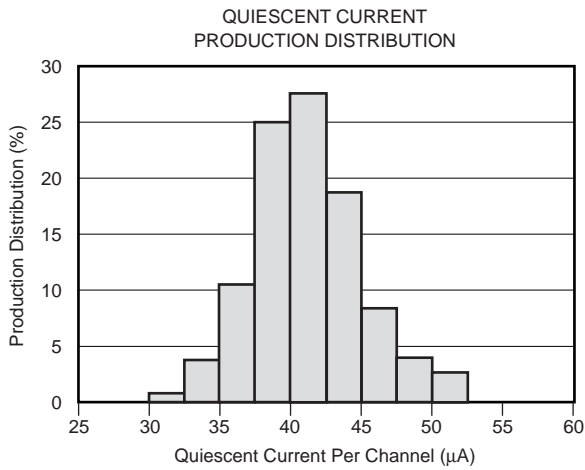

## TYPICAL PERFORMANCE CURVES (Cont.)

At  $T_A = +25^\circ\text{C}$ ,  $R_L = 20\text{k}\Omega$  connected to ground, unless otherwise noted.

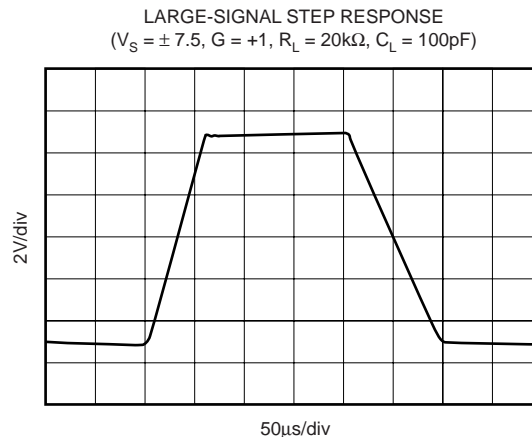
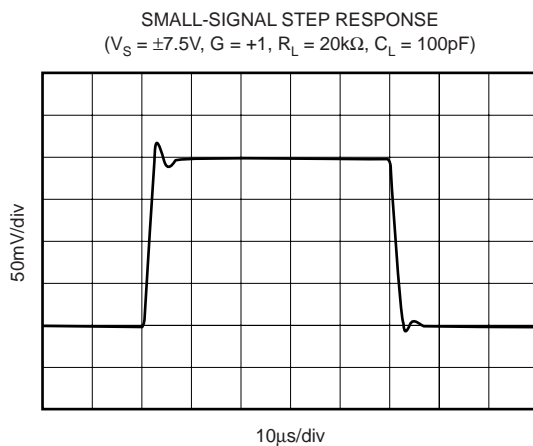

## APPLICATION INFORMATION

The OPA4243 is unity-gain stable and suitable for a wide range of general-purpose applications. The power supply pins should be bypassed with  $0.01\mu\text{F}$  ceramic capacitors.

### OPERATING VOLTAGE

The OPA4243 can operate from single supply (2.2V to 36V) or dual supplies ( $\pm 1.1\text{V}$  to  $\pm 18\text{V}$ ) with excellent performance. Unlike most op amps which are specified at only one supply voltage, the OPA4243 is specified for real world applications; a single set of specifications applies throughout the 2.6V to 36V supply range. This allows the designer to have the same assured performance at any supply voltage within this range.

In addition, many key parameters are guaranteed over the specified temperature range,  $-40^\circ\text{C}$  to  $+85^\circ\text{C}$ . Most behaviors remain unchanged throughout the full operating voltage range. Parameters, which vary significantly with operating voltage or temperature, are shown in the typical performance curves.

### PRINTED CIRCUIT BOARD LAYOUT

See Burr-Brown Application Note AB-132 for specific PC board layout recommendations.

### INPUT PROTECTION

Rail-to-rail input signals will not cause damage or invert the output of the OPA4243. To protect against ESD and excessive input voltage (beyond the supply rails) the OPA4243 includes diodes from the input terminals to the power supply rails. Normally, these diodes are reversed biased and have negligible effect on circuit operation. However, if the input voltage is allowed to exceed the supply voltages by enough to forward bias these diodes (generally, 0.3V to 0.6V) excessive input current could flow. If this condition could occur (for example, if an input signal is applied when the op amp supply voltage is zero), care should be taken to limit the input current to less than 10mA to avoid damage. An input signal beyond the supplies, with power applied, can cause an unexpected output inversion.

**PACKAGING INFORMATION**

Orderable Device	Status (1)	Package Type	Package Drawing	Pins	Package Qty	Eco Plan (2)	Lead finish/ Ball material (6)	MSL Peak Temp (3)	Op Temp (°C)	Device Marking (4/5)	Samples
OPA4243EA/250	LIFEBUY	TSSOP	PW	14	250	RoHS & Green	NIPDAU	Level-3-260C-168 HR	-40 to 85	OPA 4243EA	
OPA4243EA/2K5	ACTIVE	TSSOP	PW	14	2500	RoHS & Green	NIPDAU	Level-3-260C-168 HR	-40 to 85	OPA 4243EA	Samples

(1) The marketing status values are defined as follows:

**ACTIVE:** Product device recommended for new designs.

**LIFEBUY:** TI has announced that the device will be discontinued, and a lifetime-buy period is in effect.

**NRND:** Not recommended for new designs. Device is in production to support existing customers, but TI does not recommend using this part in a new design.

**PREVIEW:** Device has been announced but is not in production. Samples may or may not be available.

**OBsolete:** TI has discontinued the production of the device.

(2) **RoHS:** TI defines "RoHS" to mean semiconductor products that are compliant with the current EU RoHS requirements for all 10 RoHS substances, including the requirement that RoHS substance do not exceed 0.1% by weight in homogeneous materials. Where designed to be soldered at high temperatures, "RoHS" products are suitable for use in specified lead-free processes. TI may reference these types of products as "Pb-Free".

**RoHS Exempt:** TI defines "RoHS Exempt" to mean products that contain lead but are compliant with EU RoHS pursuant to a specific EU RoHS exemption.

**Green:** TI defines "Green" to mean the content of Chlorine (Cl) and Bromine (Br) based flame retardants meet JS709B low halogen requirements of <=1000ppm threshold. Antimony trioxide based flame retardants must also meet the <=1000ppm threshold requirement.

(3) MSL, Peak Temp. - The Moisture Sensitivity Level rating according to the JEDEC industry standard classifications, and peak solder temperature.

(4) There may be additional marking, which relates to the logo, the lot trace code information, or the environmental category on the device.

(5) Multiple Device Markings will be inside parentheses. Only one Device Marking contained in parentheses and separated by a "~" will appear on a device. If a line is indented then it is a continuation of the previous line and the two combined represent the entire Device Marking for that device.

(6) Lead finish/Ball material - Orderable Devices may have multiple material finish options. Finish options are separated by a vertical ruled line. Lead finish/Ball material values may wrap to two lines if the finish value exceeds the maximum column width.

**Important Information and Disclaimer:**The information provided on this page represents TI's knowledge and belief as of the date that it is provided. TI bases its knowledge and belief on information provided by third parties, and makes no representation or warranty as to the accuracy of such information. Efforts are underway to better integrate information from third parties. TI has taken and continues to take reasonable steps to provide representative and accurate information but may not have conducted destructive testing or chemical analysis on incoming materials and chemicals. TI and TI suppliers consider certain information to be proprietary, and thus CAS numbers and other limited information may not be available for release.

In no event shall TI's liability arising out of such information exceed the total purchase price of the TI part(s) at issue in this document sold by TI to Customer on an annual basis.





**TAPE AND REEL INFORMATION**

**QUADRANT ASSIGNMENTS FOR PIN 1 ORIENTATION IN TAPE**

\*All dimensions are nominal

Device	Package Type	Package Drawing	Pins	SPQ	Reel Diameter (mm)	Reel Width W1 (mm)	A0 (mm)	B0 (mm)	K0 (mm)	P1 (mm)	W (mm)	Pin1 Quadrant
OPA4243EA/250	TSSOP	PW	14	250	180.0	12.4	6.9	5.6	1.6	8.0	12.0	Q1
OPA4243EA/2K5	TSSOP	PW	14	2500	330.0	12.4	6.9	5.6	1.6	8.0	12.0	Q1

**TAPE AND REEL BOX DIMENSIONS**

\*All dimensions are nominal

Device	Package Type	Package Drawing	Pins	SPQ	Length (mm)	Width (mm)	Height (mm)
OPA4243EA/250	TSSOP	PW	14	250	210.0	185.0	35.0
OPA4243EA/2K5	TSSOP	PW	14	2500	356.0	356.0	35.0

## IMPORTANT NOTICE AND DISCLAIMER

TI PROVIDES TECHNICAL AND RELIABILITY DATA (INCLUDING DATA SHEETS), DESIGN RESOURCES (INCLUDING REFERENCE DESIGNS), APPLICATION OR OTHER DESIGN ADVICE, WEB TOOLS, SAFETY INFORMATION, AND OTHER RESOURCES "AS IS" AND WITH ALL FAULTS, AND DISCLAIMS ALL WARRANTIES, EXPRESS AND IMPLIED, INCLUDING WITHOUT LIMITATION ANY IMPLIED WARRANTIES OF MERCHANTABILITY, FITNESS FOR A PARTICULAR PURPOSE OR NON-INFRINGEMENT OF THIRD PARTY INTELLECTUAL PROPERTY RIGHTS.

These resources are intended for skilled developers designing with TI products. You are solely responsible for (1) selecting the appropriate TI products for your application, (2) designing, validating and testing your application, and (3) ensuring your application meets applicable standards, and any other safety, security, regulatory or other requirements.

These resources are subject to change without notice. TI grants you permission to use these resources only for development of an application that uses the TI products described in the resource. Other reproduction and display of these resources is prohibited. No license is granted to any other TI intellectual property right or to any third party intellectual property right. TI disclaims responsibility for, and you will fully indemnify TI and its representatives against, any claims, damages, costs, losses, and liabilities arising out of your use of these resources.

TI's products are provided subject to [TI's Terms of Sale](#) or other applicable terms available either on [ti.com](https://www.ti.com) or provided in conjunction with such TI products. TI's provision of these resources does not expand or otherwise alter TI's applicable warranties or warranty disclaimers for TI products.

TI objects to and rejects any additional or different terms you may have proposed.

Mailing Address: Texas Instruments, Post Office Box 655303, Dallas, Texas 75265  
Copyright © 2023, Texas Instruments Incorporated