

采用微封装的 TMP302-Q1 汽车级、简单易用型、低功耗温度开关

1 特性

- 符合汽车应用 要求
- 具有符合 AEC-Q100 标准的下列特性：
 - 器件温度 1 级：-40°C 至 125°C 的环境运行温度范围
 - 器件 HBM ESD 分类等级 2
 - 器件 CDM ESD 分类等级 C6
- 低功耗：15 μ A（最大值）
- SOT563 封装：1.6mm x 1.6mm x 0.6mm
- 跳闸点精度：在 40°C 至 125°C 温度范围内为 $\pm 0.2^\circ\text{C}$ （典型值）
- 引脚可选跳变点
- 开漏输出，低电平有效
- 可选滞后：5°C 或 10°C
- 低电源电压范围：1.4V 至 3.6V

2 应用

- 信息娱乐
- 汽车空调
- 引擎控制单元
- 汽车黑匣子
- 车身控制模块
- 安全气囊控制单元
- 过热监控
- 电子保护系统

3 说明

TMP302-Q1 系列器件是一款采用微封装 (SOT563) 的温度开关。TMP302-Q1 系列器件可通过引脚来选择跳闸点和迟滞，因而具有低功耗（最大 15 μ A）且简单易用的特点。

这些器件运行时无需额外组件；其功能不受微处理器或微控制器的影响。

TMP302-Q1 系列器件具有多种不同的版本，跳闸点为 50°C 至 125°C（以 5°C 为递增单位）（参阅 [器件比较表](#)）。

器件信息

器件型号	封装	
TMP302-Q1	SOT563 (6)	1.60mm x 1.20mm

- 如需了解所有可用封装，请参阅数据表末尾的可订购产品附录。

跳变阈值精度

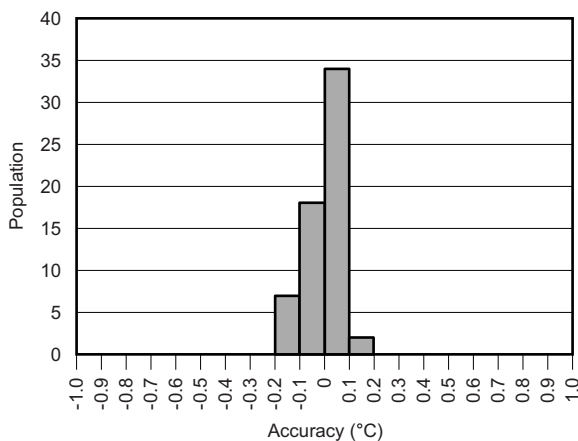

目录

<ul style="list-style-type: none"> 1 特性 1 2 应用 1 3 说明 1 4 修订历史记录 2 5 器件比较表 3 6 Pin Configuration and Functions 3 7 Specifications 4 <ul style="list-style-type: none"> 7.1 Absolute Maximum Ratings 4 7.2 ESD Ratings 4 7.3 Recommended Operating Conditions 4 7.4 Thermal Information 4 7.5 Electrical Characteristics 5 7.6 Typical Characteristics 5 8 Detailed Description 7 <ul style="list-style-type: none"> 8.1 Overview 7 8.2 Functional Block Diagram 7 	<ul style="list-style-type: none"> 8.3 Feature Description 8 8.4 Device Functional Modes 8 9 Application and Implementation 9 <ul style="list-style-type: none"> 9.1 Application Information 9 9.2 Typical Application 9 10 Power Supply Recommendations 11 11 Layout 11 <ul style="list-style-type: none"> 11.1 Layout Guidelines 11 11.2 Layout Example 11 12 器件和文档支持 12 <ul style="list-style-type: none"> 12.1 接收文档更新通知 12 12.2 社区资源 12 12.3 商标 12 12.4 静电放电警告 12 12.5 术语表 12 13 机械、封装和可订购信息 12
--	---

4 修订历史记录

Changes from Revision B (July 2015) to Revision C	Page
• Changed the supply voltage maximum value from: 3.6 V to: 4 V 4	4
• Changed the input pin supply voltage maximum value from: $V_S + 0.5$ V to: $V_S + 0.3$ and ≤ 4 V 4	4
• Changed the output pin voltage maximum value from: 3.6 V to: 4 V 4	4
• Added the specified temperature to the <i>Recommended Operating Conditions</i> table 4	4
• Updated junction-to-ambient thermal resistance from 200 to 210.3 4	4
• Updated junction-to-case (top) thermal resistance from 73.7 to 105.0 4	4
• Updated junction-to-board thermal resistance from 34.4 to 87.5 4	4
• Updated junction-to-top characterization parameter from 3.1 to 6.1 4	4
• Updated junction-to-board characterization parameter from 34.2 to 87.0 4	4
• Changed the <i>Design Requirements</i> section 10	10
• 添加了接收文档更新通知 部分 12	12

Changes from Revision A (November 2014) to Revision B	Page
• Changed the <i>Handling Ratings</i> table to <i>ESD Ratings</i> and moved storage temperature to the <i>Absolute Maximum Ratings</i> table 4	4

Changes from Original (October 2014) to Revision A	Page
• 将器件状态从“产品预览”更改为“生产” 1	1

5 器件比较表

器件	可选跳闸点 (°C) ⁽¹⁾
TMP302A-Q1	50、55、60、65
TMP302B-Q1	70、75、80、85
TMP302C-Q1	90、95、100、105
TMP302D-Q1	110、115、120、125

(1) 如需了解其他可用跳闸点，请联系 TI 代表。

6 Pin Configuration and Functions

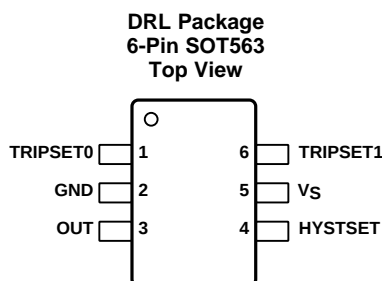

Pin Functions

NO.	PIN		TYPE	DESCRIPTION
	NAME			
1	TRIPSET0		Digital Input	Used in combination with TRIPSET1 to select the temperature at which the device trips
2	GND		Ground	Ground
3	$\overline{\text{OUT}}$		Digital Output	Open drain, active-low output
4	HYSTSET		Digital Input	Used to set amount of thermal hysteresis
5	V_S		Power Supply	Power supply
6	TRIPSET1		Digital Input	Used in combination with TRIPSET0 to select the temperature at which the device trips

7 Specifications

7.1 Absolute Maximum Ratings

over operating free-air temperature range (unless otherwise noted)⁽¹⁾

		MIN	MAX	UNIT
Voltage	Supply		4	V
	Input pin (TRIPSET0, TRIPSET1, HYSTSET)	-0.5	$V_S + 0.3$ and ≤ 4	
	Output pin ($\overline{\text{OUT}}$)	-0.5	4	
Current	Output pin ($\overline{\text{OUT}}$)		10	mA
Temperature	Operating	-55	130	°C
	Junction		150	
	Storage	-60	150	

(1) Stresses beyond those listed under *Absolute Maximum Ratings* may cause permanent damage to the device. These are stress ratings only, which do not imply functional operation of the device at these or any other conditions beyond those indicated under *Recommended Operating Conditions*. Exposure to absolute-maximum-rated conditions for extended periods may affect device reliability.

7.2 ESD Ratings

		VALUE	UNIT
V_{ESD} Electrostatic discharge	Human body model (HBM), per AEC Q100-002 ⁽¹⁾	± 2000	V
	Charged device model (CDM), per AEC Q100-011	± 1000	

(1) AEC Q100-002 indicates HBM stressing is done in accordance with the ANSI/ESDA/JEDEC JS-001 specification.

7.3 Recommended Operating Conditions

over operating free-air temperature range (unless otherwise noted)

		MIN	NOM	MAX	UNIT
V_S	Power supply voltage	1.4	3.3	3.6	V
R_{pullup}	Pullup resistor connected from $\overline{\text{OUT}}$ to V_S	10		100	k Ω
T_A	Specified temperature	-40		125	°C

7.4 Thermal Information

THERMAL METRIC ⁽¹⁾		TMP302-Q1	UNIT
		DRL (SOT563)	
		6 PINS	
$R_{\theta\text{JA}}$	Junction-to-ambient thermal resistance	210.3	°C/W
$R_{\theta\text{JC(top)}}$	Junction-to-case (top) thermal resistance	105.0	°C/W
$R_{\theta\text{JB}}$	Junction-to-board thermal resistance	87.5	°C/W
Ψ_{JT}	Junction-to-top characterization parameter	6.1	°C/W
Ψ_{JB}	Junction-to-board characterization parameter	87.0	°C/W

(1) For more information about traditional and new thermal metrics, see the [Semiconductor and IC Package Thermal Metrics](#) application report (SPRA953).

7.5 Electrical Characteristics

At $T_A = -40^{\circ}\text{C}$ to $+125^{\circ}\text{C}$, and $V_S = 1.4$ to 3.6 V (unless otherwise noted). 100% of all units are production tested at $T_A = 25^{\circ}\text{C}$; overtemperature specifications are specified by design.

PARAMETER	TEST CONDITIONS	MIN	TYP	MAX	UNIT
TEMPERATURE MEASUREMENT					
Trip point accuracy			± 0.2	± 2	$^{\circ}\text{C}$
Trip point accuracy versus supply			± 0.2	± 0.5	$^{\circ}\text{C}/\text{V}$
Trip point hysteresis	HYSTSET = GND		5		$^{\circ}\text{C}$
	HYSTSET = V_S		10		$^{\circ}\text{C}$
TEMPERATURE TRIP POINT SET					
Temperature trip point set	TRIPSET1 = GND, TRIPSET0 = GND		Default		$^{\circ}\text{C}$
	TRIPSET1 = GND, TRIPSET0 = V_S		Default + 5		$^{\circ}\text{C}$
	TRIPSET1 = V_S , TRIPSET0 = GND		Default + 10		$^{\circ}\text{C}$
	TRIPSET1 = V_S , TRIPSET0 = V_S		Default + 15		$^{\circ}\text{C}$
HYSTERESIS SET INPUT					
V_{IH} Input logic level high		$0.7 \times V_S$		V_S	V
V_{IL} Input logic level low		-0.5		$0.3 \times V_S$	V
I_I Input current	$0 < V_I < 3.6\text{ V}$			1	μA
DIGITAL OUTPUT					
V_{OL} Output logic level low	$V_S > 2\text{ V}$, $I_{OL} = 3\text{ mA}$	0		0.4	V
	$V_S < 2\text{ V}$, $I_{OL} = 3\text{ mA}$	0		$0.2 \times V_S$	V
POWER SUPPLY					
Operating Supply Range		1.4		3.6	V
I_Q Quiescent Current	$T_A = -40^{\circ}\text{C}$ to $+125^{\circ}\text{C}$		8	15	μA
	$V_S = 3.3\text{ V}$, $T_A = 50^{\circ}\text{C}$		7		μA

7.6 Typical Characteristics

At $T_A = 25^{\circ}\text{C}$ and $V_S = 3.3\text{ V}$, unless otherwise noted.

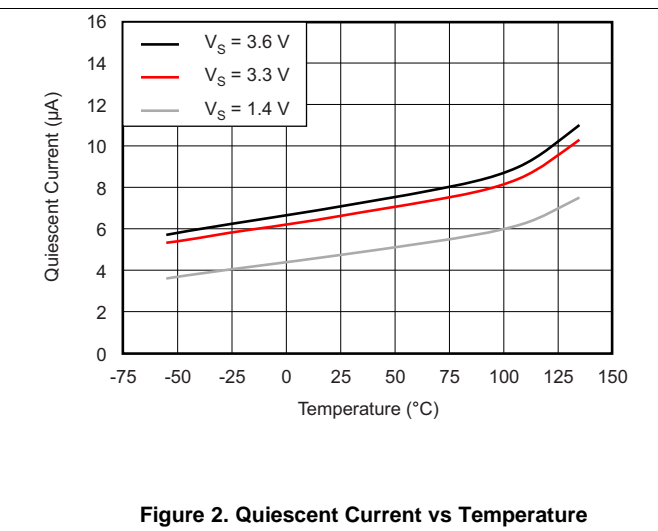
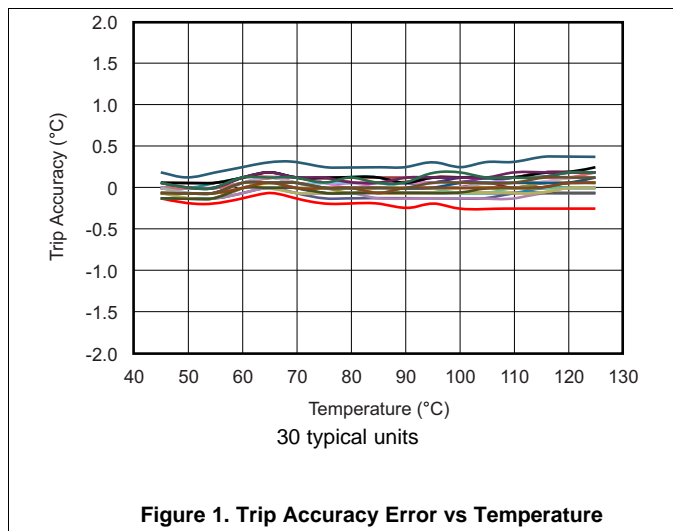

Typical Characteristics (continued)

At $T_A = 25^\circ\text{C}$ and $V_S = 3.3\text{ V}$, unless otherwise noted.

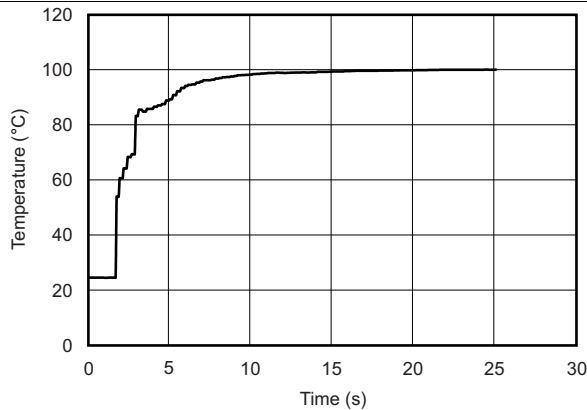

Figure 3. Temperature Step Response in Perfluorinated Fluid at 100°C vs Time

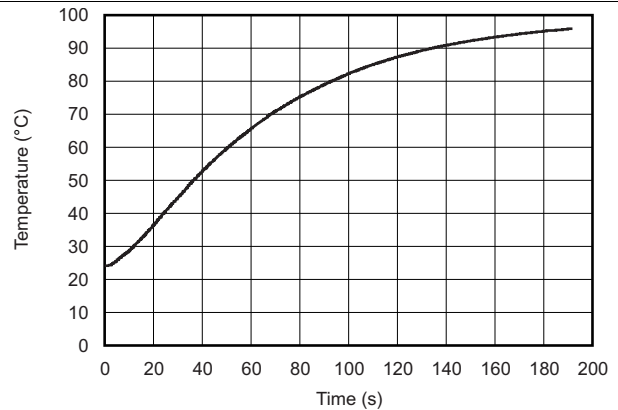

Figure 4. Thermal Step Response in Air at 100°C vs Time

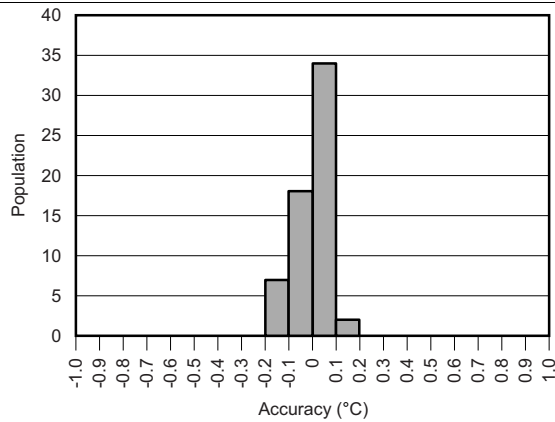

Figure 5. Trip Threshold Accuracy

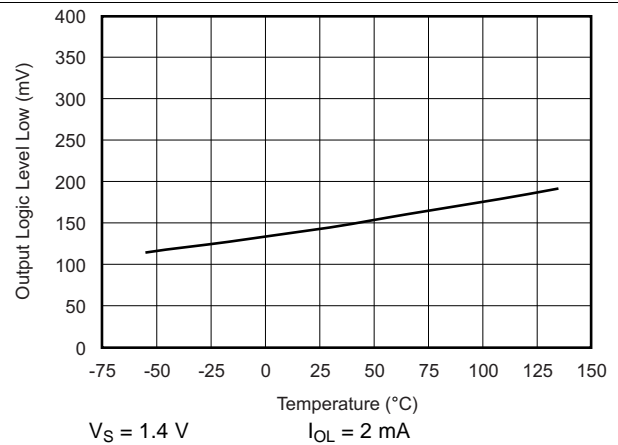

Figure 6. Output Logic-Level Low V_{OL} vs Temperature

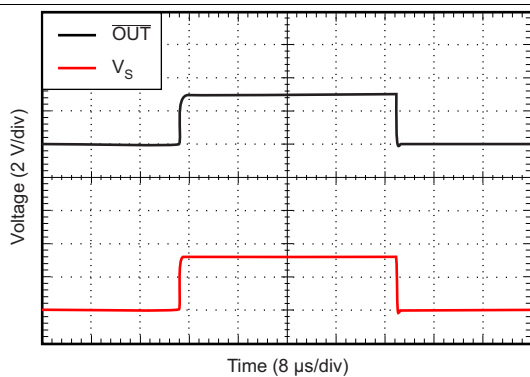

Figure 7. Power-Up and Power-Down Response

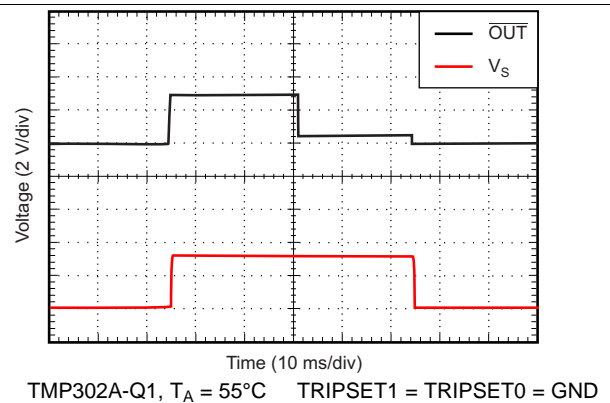

Figure 8. Power-Up, Trip, and Power-Down Response

8 Detailed Description

8.1 Overview

The TMP302-Q1 temperature switch is optimal for ultra low-power applications that require accurate trip thresholds. A temperature switch is a device that issues an alert response when a temperature threshold is reached or exceeded. The trip thresholds are programmable to four different settings using the TRIPSET1 and TRIPSET0 pins. Table 1 lists the pin settings versus trip points.

Table 1. Trip Point versus TRIPSET1 and TRIPSET0

TRIPSET1	TRIPSET0	TMP302A-Q1	TMP302B-Q1	TMP302C-Q1	TMP302D-Q1
GND	GND	50°C	70°C	90°C	110°C
GND	V _S	55°C	75°C	95°C	115°C
V _S	GND	60°C	80°C	100°C	120°C
V _S	V _S	65°C	85°C	105°C	125°C

8.2 Functional Block Diagram

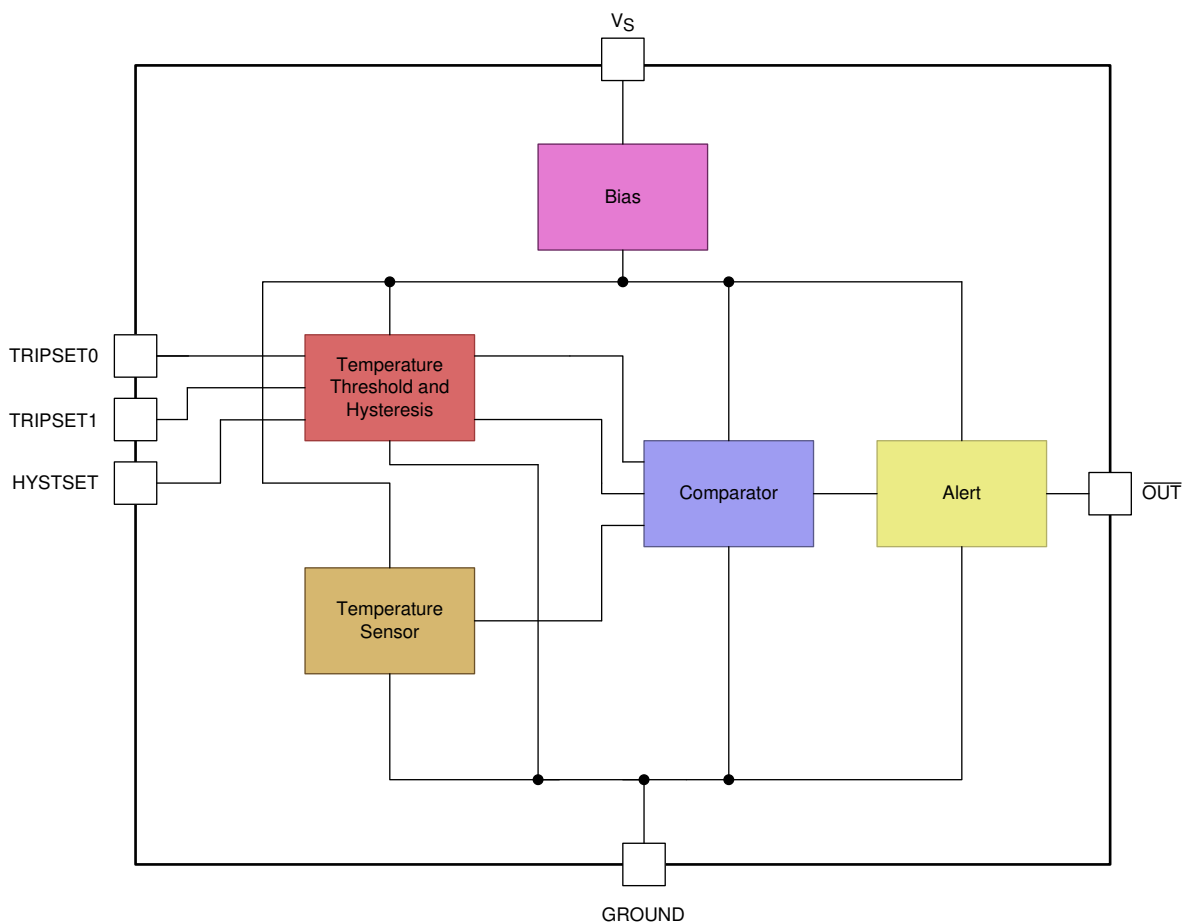

8.3 Feature Description

8.3.1 HYSTSET

If the temperature trip threshold is crossed, the open-drain, active low output ($\overline{\text{OUT}}$) goes low and does not return to the original high state (that is, V_S) until the temperature returns to a value within a hysteresis window set by the HYSTSET pin. The HYSTSET pin allows the user to choose between a 5°C and a 10°C hysteresis window. [Table 2](#) lists the hysteresis window that corresponds to the HYSTSET setting.

Table 2. HYSTSET Window

HYSTSET	THRESHOLD HYSTERESIS
GND	5°C
V_S	10°C

For the specific case of the device, if the HYSTSET pin is set to 10°C (that is, connected to V_S) and the device is configured with a 60°C trip point ($\text{TRIPSET1} = V_S$, $\text{TRIPSET0} = \text{GND}$), when this threshold is exceeded the output does not return to the original high state until it reaches 50°C. This case is more clearly shown in [Figure 9](#).

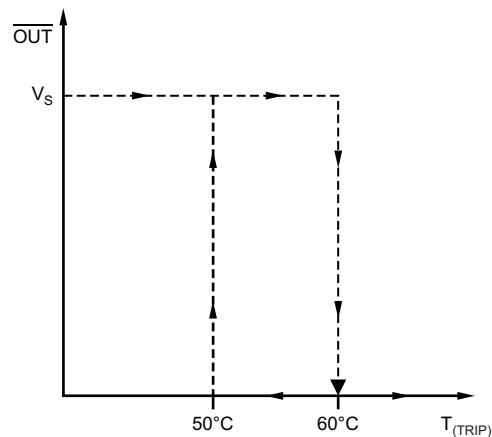

Figure 9. TMP302A-Q1: HYSTSET = V_S , TRIPSET1 = V_S , TRIPSET0 = GND

8.4 Device Functional Modes

The TMP302-Q1 family of devices has a single functional mode. Normal operation for the TMP302-Q1 family of devices occurs when the power-supply voltage applied between the V_S pin and GND is within the specified operating range of 1.4 to 3.6 V. The temperature threshold is selected by connecting the TRIPSET0 and TRIPSET1 pins to either the GND or V_S pins (see [Table 1](#)). Hysteresis is selected by connecting the HYSTSET pin to either the GND or V_S pins (see [Table 2](#)). The output pin, $\overline{\text{OUT}}$, remains high when the temperature is below the selected temperature threshold. The $\overline{\text{OUT}}$ pin remains low when the temperature is at or above the selected temperature threshold. The $\overline{\text{OUT}}$ pin returns from a low state back to the high state based upon the amount of selected hysteresis (see the [HYSTSET](#) section).

9 Application and Implementation

NOTE

Information in the following applications sections is not part of the TI component specification, and TI does not warrant its accuracy or completeness. TI's customers are responsible for determining suitability of components for their purposes. Customers should validate and test their design implementation to confirm system functionality.

9.1 Application Information

9.1.1 Configuring the TMP302-Q1

The TMP302-Q1 family of devices is simple to configure. The only external components that the device requires are a bypass capacitor and pullup resistor. Power-supply bypassing is strongly recommended. Use a 0.1- μ F capacitor placed as close as possible to the supply pin. To minimize the internal power dissipation of the TMP302-Q1 family of devices, use a pullup resistor value greater than 10 k Ω from the $\overline{\text{OUT}}$ pin to the V_S pin. Refer to Table 1 for trip-point temperature configuration. The TRIPSET pins can be toggled dynamically; however, the voltage of these pins must not exceed V_S . To ensure a proper logic high, the voltage must not drop below $0.7 \text{ V} \times V_S$.

9.2 Typical Application

Figure 10 shows the typical circuit configuration for the TMP302-Q1 family of devices. The TMP302-Q1 family of devices is configured for the default temperature threshold by connecting the TRIPSET0 and TRIPSET1 pins directly to ground. Connecting the HYSTSET pin to ground configures the device for 5°C of hysteresis. Place a 10-k Ω pullup resistor between the $\overline{\text{OUT}}$ and V_S pins. Place a 0.1- μ F bypass capacitor between the V_S pin and ground, close to the TMP302-Q1 device.

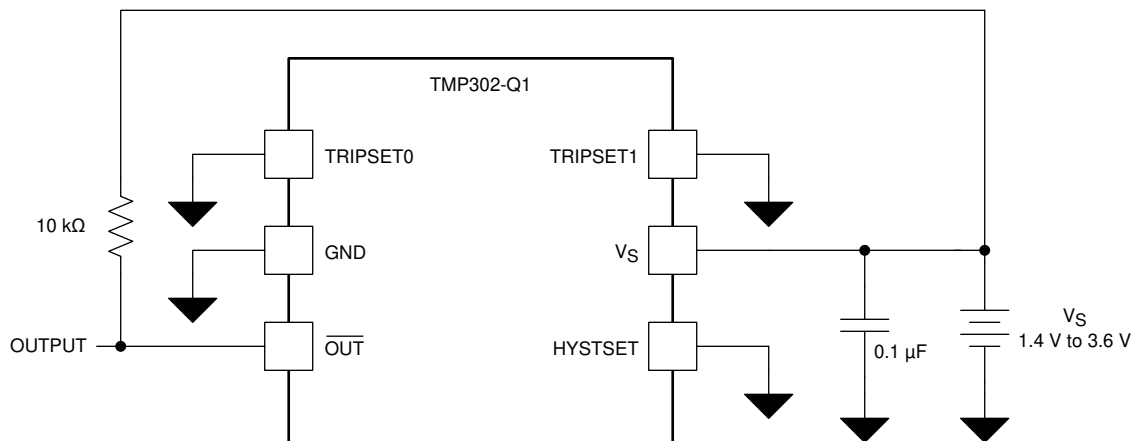

Figure 10. TMP302-Q1 Typical Application Schematic

Figure 11 shows the most generic implementation of the TMP302-Q1 family of devices. Switches are shown connecting the TMPSET0, TMPSET1 and HYSTSET pins to either V_S or ground. The use of switches is not strictly required; the switches are shown only to illustrate the various pin connection combinations. In practice, connecting the TMPSET0, TMPSET1 and HYSTSET pins to ground or directly to the V_S pin is sufficient and minimizes space and cost. If additional flexibility is desired, connections from the TMPSET0, TMPSET1 and HYSTSET pins can be made through 0- Ω resistors which can be either populated or not populated depending upon the desired connection.

Typical Application (continued)

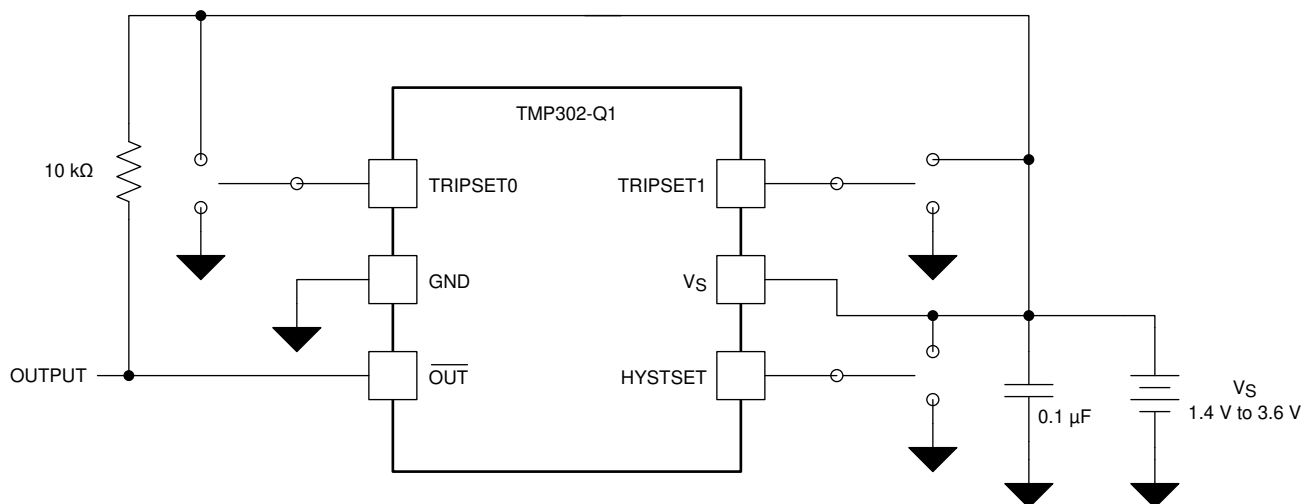

Figure 11. TMP302-Q1 Generic Application Schematic

9.2.1 Design Requirements

Designing with the TMP302-Q1 family of devices is simple. The TMP302-Q1 family of devices is a temperature switch commonly used to signal a microprocessor in the event of an over temperature condition. The temperature at which the TMP302-Q1 family of devices issues an active low alert is determined by the configuration of the TRIPSET0 and TRIPSET1 pins. These two pins are digital inputs and must be tied either high or low, according to Table 1. The TMP302-Q1 family of devices issues an active low alert when the temperature threshold is exceeded. The device has built-in hysteresis to avoid the device from signaling the microprocessor as soon as the temperature drops below the temperature threshold. The amount of hysteresis is determined by the HYSTSET pin. This pin is a digital input and must be tied either high or low, according to Table 2.

See Figure 10 and Figure 11 for typical circuit configurations.

9.2.2 Detailed Design Procedure

Determine the threshold temperature and hysteresis required for the application. Connect the TRIPSET0, TRIPSET1, and HYSTSET pins according to the design requirements. Refer to Table 1 and Table 2. Use a 10-kΩ pullup resistor from the $\overline{\text{OUT}}$ pin to the V_S pin. To minimize power, a larger-value pullup resistor can be used but must not exceed 100 kΩ. Place a 0.1-μF bypass capacitor close to the TMP302-Q1 device to reduce noise coupled from the power supply.

9.2.3 Application Curves

Figure 12 and Figure 13 show the TMP302A-Q1 power-on response with the ambient temperature less than 50°C and greater than 50°C respectively. The TMP302A-Q1 was configured with trip point set to 50°C. The TMP302B-Q1, TMP302C-Q1, and TMP302D-Q1 devices behave similarly with regards to power on response with T_A below or above the trip point. Note that the $\overline{\text{OUT}}$ signal typically requires 35 ms following power on to become valid.

Typical Application (continued)

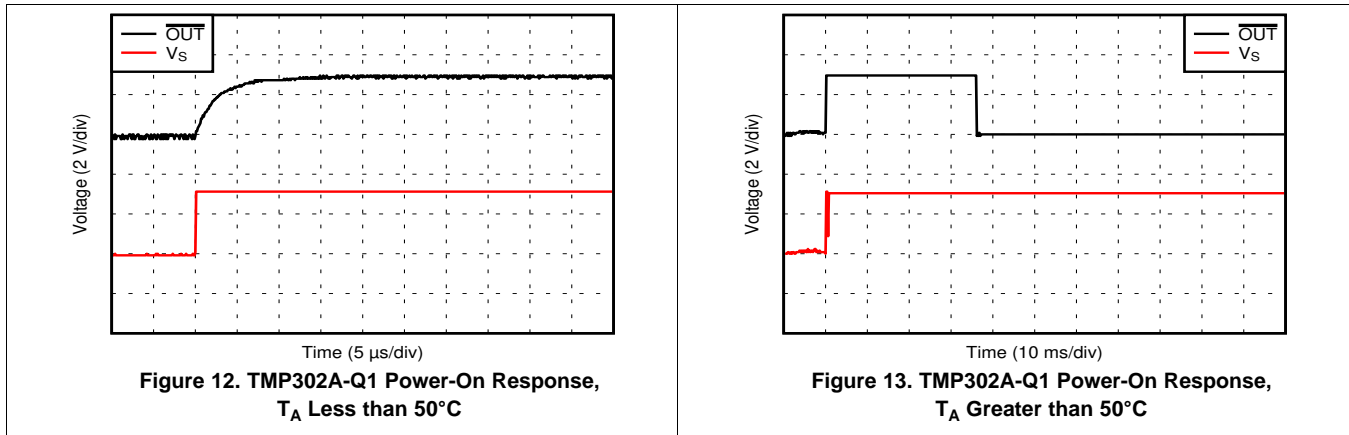

10 Power Supply Recommendations

The TMP302-Q1 family of devices is designed to operate from a single power supply within the range 1.4 V and 3.6 V. No specific power supply sequencing with respect to any of the input or output pins is required. The TMP302-Q1 family of devices is fully functional within 35 ms of the voltage at the V_S pin reaching or exceeding 1.4 V.

11 Layout

11.1 Layout Guidelines

Place the power supply bypass capacitor as close as possible to the V_S and GND pins. The recommended value for this bypass capacitor is 0.1- μF . Additional bypass capacitance can be added to compensate for noisy or high-impedance power supplies. Place a 10-k Ω pullup resistor from the open drain $\overline{\text{OUT}}$ pin to the power supply pin V_S .

11.2 Layout Example

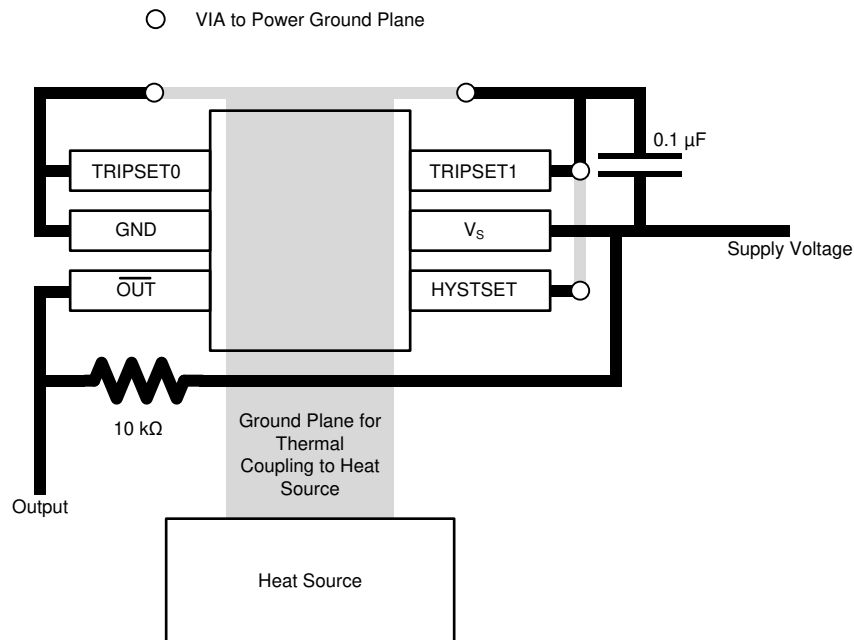

Figure 14. Layout Example

12 器件和文档支持

12.1 接收文档更新通知

要接收文档更新通知，请导航至 TI.com.cn 上的器件产品文件夹。单击右上角的通知我进行注册，即可每周接收产品信息更改摘要。有关更改的详细信息，请查阅已修订文档中包含的修订历史记录。

12.2 社区资源

下列链接提供到 TI 社区资源的连接。链接的内容由各个分销商“按照原样”提供。这些内容并不构成 TI 技术规范，并且不一定反映 TI 的观点；请参阅 TI 的《使用条款》。

TI E2E™ 在线社区 *TI 的工程师对工程师 (E2E) 社区*。此社区的创建目的在于促进工程师之间的协作。在 e2e.ti.com 中，您可以咨询问题、分享知识、拓展思路并与同行工程师一道帮助解决问题。

设计支持 *TI 参考设计支持* 可帮助您快速查找有帮助的 E2E 论坛、设计支持工具以及技术支持的联系信息。

12.3 商标

E2E is a trademark of Texas Instruments.

All other trademarks are the property of their respective owners.

12.4 静电放电警告



这些装置包含有限的内置 ESD 保护。存储或装卸时，应将导线一起截短或将装置放置于导电泡棉中，以防止 MOS 门极遭受静电损伤。

12.5 术语表

SLYZ022 — *TI 术语表*。

这份术语表列出并解释术语、缩写和定义。

13 机械、封装和可订购信息

以下页面包含机械、封装和可订购信息。这些信息是指定器件的最新可用数据。数据如有变更，恕不另行通知，且不会对此文档进行修订。如需获取此数据表的浏览器版本，请查阅左侧的导航栏。

PACKAGING INFORMATION

Orderable Device	Status (1)	Package Type	Package Drawing	Pins	Package Qty	Eco Plan (2)	Lead finish/ Ball material (6)	MSL Peak Temp (3)	Op Temp (°C)	Device Marking (4/5)	Samples
TMP302AQDRLRQ1	ACTIVE	SOT-5X3	DRL	6	4000	RoHS & Green	NIPDAUAG	Level-2-260C-1 YEAR	-40 to 125	SHQ	Samples
TMP302BQDRLRQ1	ACTIVE	SOT-5X3	DRL	6	4000	RoHS & Green	NIPDAUAG	Level-2-260C-1 YEAR	-40 to 125	SHR	Samples
TMP302CQDRLRQ1	ACTIVE	SOT-5X3	DRL	6	4000	RoHS & Green	NIPDAUAG	Level-2-260C-1 YEAR	-40 to 125	SHS	Samples
TMP302DQDRLRQ1	ACTIVE	SOT-5X3	DRL	6	4000	RoHS & Green	NIPDAUAG	Level-2-260C-1 YEAR	-40 to 125	SHT	Samples

(1) The marketing status values are defined as follows:

ACTIVE: Product device recommended for new designs.

LIFEBUY: TI has announced that the device will be discontinued, and a lifetime-buy period is in effect.

NRND: Not recommended for new designs. Device is in production to support existing customers, but TI does not recommend using this part in a new design.

PREVIEW: Device has been announced but is not in production. Samples may or may not be available.

OBSELETE: TI has discontinued the production of the device.

(2) **RoHS:** TI defines "RoHS" to mean semiconductor products that are compliant with the current EU RoHS requirements for all 10 RoHS substances, including the requirement that RoHS substance do not exceed 0.1% by weight in homogeneous materials. Where designed to be soldered at high temperatures, "RoHS" products are suitable for use in specified lead-free processes. TI may reference these types of products as "Pb-Free".

RoHS Exempt: TI defines "RoHS Exempt" to mean products that contain lead but are compliant with EU RoHS pursuant to a specific EU RoHS exemption.

Green: TI defines "Green" to mean the content of Chlorine (Cl) and Bromine (Br) based flame retardants meet JS709B low halogen requirements of <=1000ppm threshold. Antimony trioxide based flame retardants must also meet the <=1000ppm threshold requirement.

(3) MSL, Peak Temp. - The Moisture Sensitivity Level rating according to the JEDEC industry standard classifications, and peak solder temperature.

(4) There may be additional marking, which relates to the logo, the lot trace code information, or the environmental category on the device.

(5) Multiple Device Markings will be inside parentheses. Only one Device Marking contained in parentheses and separated by a "-" will appear on a device. If a line is indented then it is a continuation of the previous line and the two combined represent the entire Device Marking for that device.

(6) Lead finish/Ball material - Orderable Devices may have multiple material finish options. Finish options are separated by a vertical ruled line. Lead finish/Ball material values may wrap to two lines if the finish value exceeds the maximum column width.

Important Information and Disclaimer:The information provided on this page represents TI's knowledge and belief as of the date that it is provided. TI bases its knowledge and belief on information provided by third parties, and makes no representation or warranty as to the accuracy of such information. Efforts are underway to better integrate information from third parties. TI has taken and

continues to take reasonable steps to provide representative and accurate information but may not have conducted destructive testing or chemical analysis on incoming materials and chemicals. TI and TI suppliers consider certain information to be proprietary, and thus CAS numbers and other limited information may not be available for release.

In no event shall TI's liability arising out of such information exceed the total purchase price of the TI part(s) at issue in this document sold by TI to Customer on an annual basis.

TAPE AND REEL INFORMATION

QUADRANT ASSIGNMENTS FOR PIN 1 ORIENTATION IN TAPE

*All dimensions are nominal

Device	Package Type	Package Drawing	Pins	SPQ	Reel Diameter (mm)	Reel Width W1 (mm)	A0 (mm)	B0 (mm)	K0 (mm)	P1 (mm)	W (mm)	Pin1 Quadrant
TMP302AQDRLRQ1	SOT-5X3	DRL	6	4000	180.0	8.4	1.98	1.78	0.69	4.0	8.0	Q3
TMP302BQDRLRQ1	SOT-5X3	DRL	6	4000	180.0	8.4	1.98	1.78	0.69	4.0	8.0	Q3
TMP302CQDRLRQ1	SOT-5X3	DRL	6	4000	180.0	8.4	1.98	1.78	0.69	4.0	8.0	Q3
TMP302DQDRLRQ1	SOT-5X3	DRL	6	4000	180.0	8.4	1.98	1.78	0.69	4.0	8.0	Q3

TAPE AND REEL BOX DIMENSIONS

*All dimensions are nominal

Device	Package Type	Package Drawing	Pins	SPQ	Length (mm)	Width (mm)	Height (mm)
TMP302AQDRLRQ1	SOT-5X3	DRL	6	4000	223.0	270.0	35.0
TMP302BQDRLRQ1	SOT-5X3	DRL	6	4000	223.0	270.0	35.0
TMP302CQDRLRQ1	SOT-5X3	DRL	6	4000	223.0	270.0	35.0
TMP302DQDRLRQ1	SOT-5X3	DRL	6	4000	223.0	270.0	35.0

DRL0006A

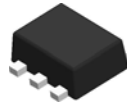

PACKAGE OUTLINE

SOT - 0.6 mm max height

PLASTIC SMALL OUTLINE

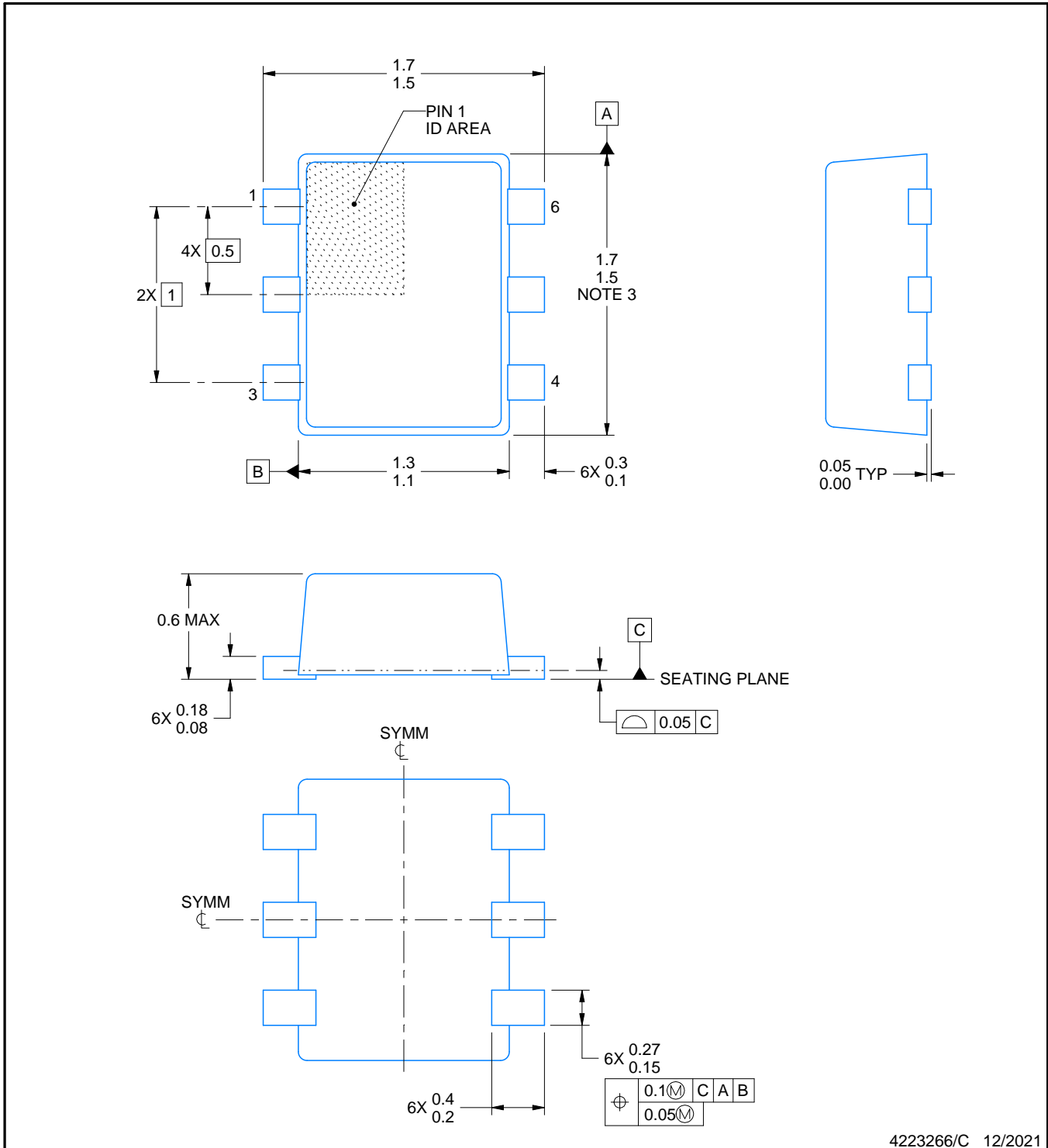

NOTES:

1. All linear dimensions are in millimeters. Any dimensions in parenthesis are for reference only. Dimensioning and tolerancing per ASME Y14.5M.
2. This drawing is subject to change without notice.
3. This dimension does not include mold flash, protrusions, or gate burrs. Mold flash, protrusions, or gate burrs shall not exceed 0.15 mm per side.
4. Reference JEDEC registration MO-293 Variation UAAD

EXAMPLE BOARD LAYOUT

DRL0006A

SOT - 0.6 mm max height

PLASTIC SMALL OUTLINE

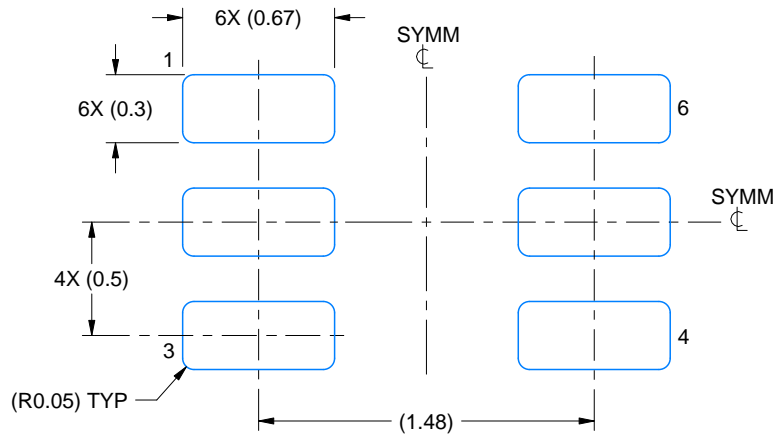

LAND PATTERN EXAMPLE
SCALE:30X

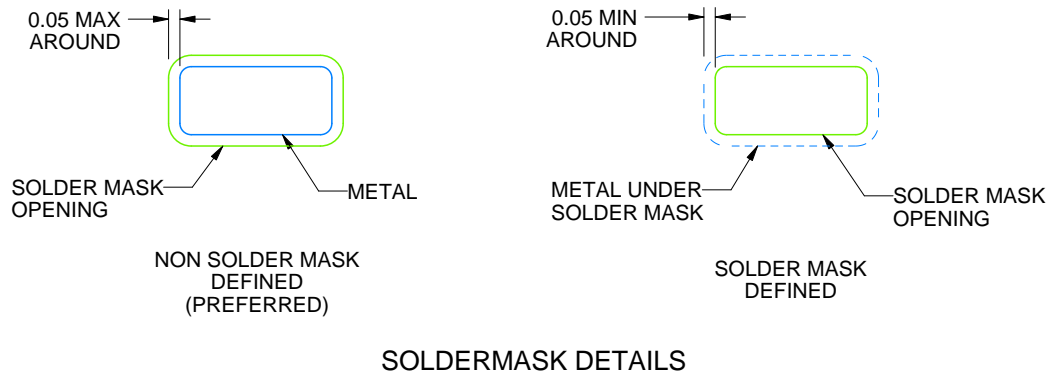

SOLDERMASK DETAILS

4223266/C 12/2021

NOTES: (continued)

5. Publication IPC-7351 may have alternate designs.
6. Solder mask tolerances between and around signal pads can vary based on board fabrication site.
7. Land pattern design aligns to IPC-610, Bottom Termination Component (BTC) solder joint inspection criteria.

EXAMPLE STENCIL DESIGN

DRL0006A

SOT - 0.6 mm max height

PLASTIC SMALL OUTLINE

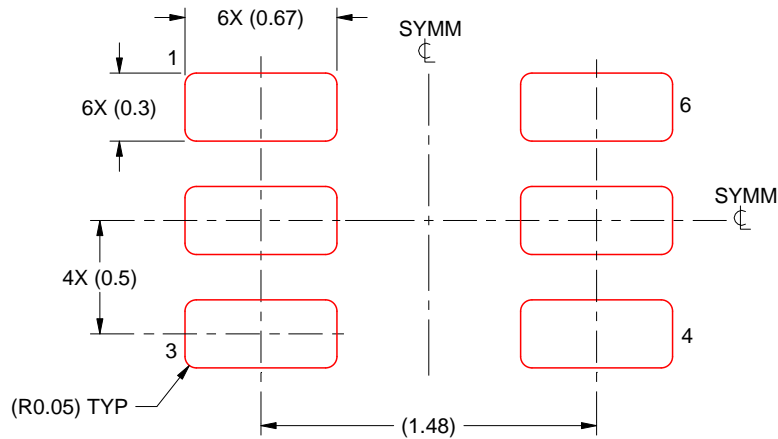

SOLDER PASTE EXAMPLE
BASED ON 0.1 mm THICK STENCIL
SCALE:30X

4223266/C 12/2021

NOTES: (continued)

8. Laser cutting apertures with trapezoidal walls and rounded corners may offer better paste release. IPC-7525 may have alternate design recommendations.
9. Board assembly site may have different recommendations for stencil design.

重要声明和免责声明

TI“按原样”提供技术和可靠性数据（包括数据表）、设计资源（包括参考设计）、应用或其他设计建议、网络工具、安全信息和其他资源，不保证没有瑕疵且不做任何明示或暗示的担保，包括但不限于对适销性、某特定用途方面的适用性或不侵犯任何第三方知识产权的暗示担保。

这些资源可供使用 TI 产品进行设计的熟练开发人员使用。您将自行承担以下全部责任：(1) 针对您的应用选择合适的 TI 产品，(2) 设计、验证并测试您的应用，(3) 确保您的应用满足相应标准以及任何其他功能安全、信息安全、监管或其他要求。

这些资源如有变更，恕不另行通知。TI 授权您仅可将这些资源用于研发本资源所述的 TI 产品的应用。严禁对这些资源进行其他复制或展示。您无权使用任何其他 TI 知识产权或任何第三方知识产权。您应全额赔偿因在这些资源的使用中对 TI 及其代表造成的任何索赔、损害、成本、损失和债务，TI 对此概不负责。

TI 提供的产品受 [TI 的销售条款](#) 或 [ti.com](#) 上其他适用条款/TI 产品随附的其他适用条款的约束。TI 提供这些资源并不会扩展或以其他方式更改 TI 针对 TI 产品发布的适用的担保或担保免责声明。

TI 反对并拒绝您可能提出的任何其他或不同的条款。

邮寄地址：Texas Instruments, Post Office Box 655303, Dallas, Texas 75265

Copyright © 2022，德州仪器 (TI) 公司