

TPD3S0x4 针对 USB 主机端口的限流开关和 D+/D- ESD 保护

1 特性

- 连续额定电流为 0.5A 和 1.5A
- 恒定电流限制固定为 0.85A 和 2.15A（典型值）
- 快速过流响应 – 2 μ s
- 集成输出放电
- 反向电流阻断
- 短路保护功能
- 过热保护，支持自动重启
- 内置软启动
- 环境温度范围：-40°C 至 85°C
- 产品遵从规范
 - UL 认证元件（UL 2367, 固态过流保护器标准）
 - CB 文件号 E169910 至 IEC 60950-1，信息技术设备
- IEC 61000-4-2 4 级静电放电 (ESD) 保护（外部引脚）
 - \pm 12kV 接触放电 (IEC 61000-4-2)
 - \pm 15kV 空气间隙放电 (IEC 61000-4-2)

2 应用

- USB 端口/集线器
- 便携式计算机，台式机
- 高清数字电视
- 机顶盒

4 简化电路原理图

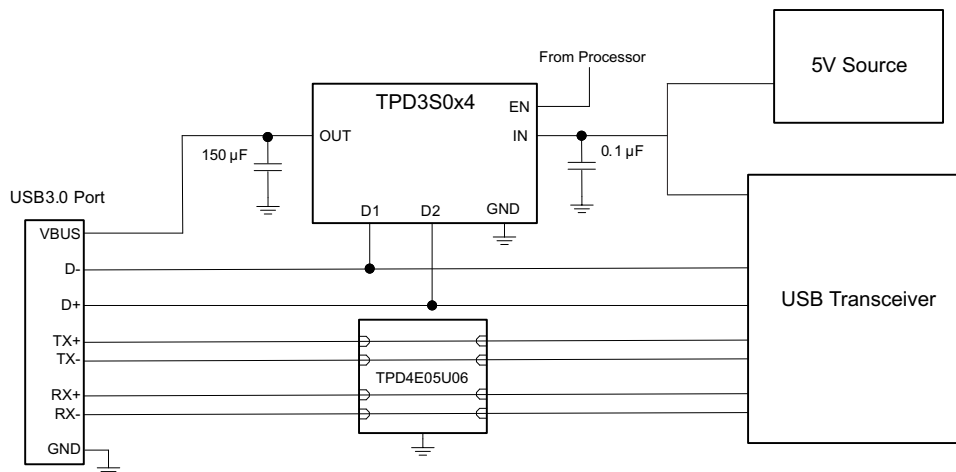

3 说明

TPD3S0x4 集成器件配有一个限流负载开关和一个基于双通道瞬态电压抑制器 (TVS) 的静电放电 (ESD) 保护二极管阵列，适用于 USB 接口。

TPD3S0x4 器件适用于可能出现大电容负载和短路的应用（如 USB 接口）；TPD3S0x4 可提供短路保护和过流保护。当输出负载超过电流限制阈值时，TPD3S0x4 通过在恒定电流模式下运行即可将输出电流限制到安全水平。快速过载响应特性有助于减轻 5V 主电源的负担，当输出短路时可以快速调节电源。电流限制开关的上升和下降此时受到控制，力求尽量减小器件开关过程中的浪涌电流。

TPD3S014 和 TPD3S044 的连续电流分别为 0.5A 和 1.5A。TVS 二极管阵列的额定 ESD 冲击消散值高于 IEC 61000-4-2 国际标准中规定的最高水平。此器件高度集成，并且采用易于布线的 DBV 封装，可对便携式计算机、高清数字 TV 和机顶盒等应用中的 USB 接口提供强力的电路保护。

器件信息⁽¹⁾

器件型号	封装	封装尺寸（标称值）
TPD3S0x4	DBV (6)	2.90mm x 2.80mm

(1) 要了解所有可用封装，请见数据表末尾的可订购产品附录。



目录

<ul style="list-style-type: none"> 1 特性 1 2 应用 1 3 说明 1 4 简化电路原理图 1 5 修订历史记录 2 6 Device Comparison 3 7 Pin Configuration and Functions 3 8 Specifications 4 <ul style="list-style-type: none"> 8.1 Absolute Maximum Ratings 4 8.2 ESD Ratings 4 8.3 Recommended Operating Conditions 4 8.4 Thermal Information 5 8.5 Electrical Characteristics: $T_J = T_A = 25^\circ\text{C}$ 5 8.6 Electrical Characteristics: $-40^\circ\text{C} \leq T_J \leq 125^\circ\text{C}$ 6 8.7 Typical Characteristics 7 9 Detailed Description 12 	<ul style="list-style-type: none"> 9.1 Overview 12 9.2 Functional Block Diagram 12 9.3 Feature Description 12 9.4 Device Functional Modes 16 10 Application and Implementation 17 <ul style="list-style-type: none"> 10.1 Application Information 17 10.2 Typical Application 17 11 Power Supply Recommendations 21 12 Layout 21 <ul style="list-style-type: none"> 12.1 Layout Guidelines 21 12.2 Layout Examples 21 13 器件和文档支持 23 <ul style="list-style-type: none"> 13.1 相关链接 23 13.2 商标 23 13.3 静电放电警告 23 13.4 术语表 23 14 机械封装和可订购信息 23
--	---

5 修订历史记录

Changes from Original (October 2014) to Revision A

Page

<ul style="list-style-type: none"> • 已将文档更新为完整版。 1 	1
---	---

6 Device Comparison

PART NUMBER	MAXIMUM OPERATING CURRENT	OUTPUT DISCHARGE	ENABLE	PACKAGED DEVICE AND MARKING SOT23-6 (DBV)
TPD3S014	0.5 A	Y	High	SII
TPD3S044	1.5 A	Y	High	SIJ

7 Pin Configuration and Functions

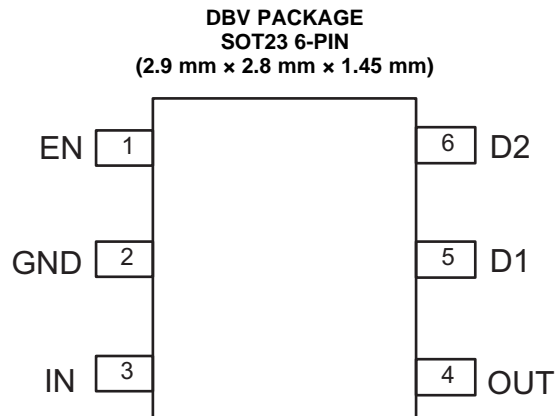

Pin Functions

PIN		DESCRIPTION
NAME	NO.	
D1	5	USB data+ or USB data-
D2	6	
EN	1	Enable input, logic high turns on power switch
GND	2	Ground
IN	3	Input voltage and power-switch drain; Connect a 0.1 μ F or greater ceramic capacitor from IN to GND close to the IC
OUT	4	Power-switch output, connect to load

8 Specifications

8.1 Absolute Maximum Ratings

 over operating free-air temperature (unless otherwise noted)⁽¹⁾⁽²⁾

		MIN	MAX	UNIT
Input voltage ⁽³⁾	V _{IN}	-0.3	6	V
	V _{OUT}	-0.3	6	
	EN	-0.3	6	
	D1	-0.3	6	
	D2	-0.3	6	
Voltage range from V _{IN} to V _{OUT}		-6	6	V
Junction temperature, T _J		Internally limited		
Storage temperature range, T _{stg}		-65	150	°C

- (1) Stresses beyond those listed under *Absolute Maximum Ratings* may cause permanent damage to the device. These are stress ratings only, which do not imply functional operation of the device at these or any other conditions beyond those indicated under *Recommended Operating Conditions*. Exposure to absolute-maximum-rated conditions for extended periods may affect device reliability.
- (2) Voltages are with respect to GND unless otherwise noted.
- (3) See the *Input and Output Capacitance* section.

8.2 ESD Ratings

			VALUE	UNIT
V _(ESD)	Electrostatic discharge	Human body model (HBM), per ANSI/ESDA/JEDEC JS-001 ⁽¹⁾	All pins	±2000
		Charged device model (CDM), per JEDEC specification JESD22-C101 ⁽²⁾	All pins	±500
		IEC 61000-4-2 Contact Discharge ⁽³⁾	V _{OUT} , Dx pins	±12000
		IEC 61000-4-2 Air-Gap Discharge ⁽³⁾	V _{OUT} , Dx pins	±15000

- (1) JEDEC document JEP155 states that 500-V HBM allows safe manufacturing with a standard ESD control process. Pins listed as ±2000 V may actually have higher performance.
- (2) JEDEC document JEP157 states that 250-V CDM allows safe manufacturing with a standard ESD control process. Pins listed as ±500 V may actually have higher performance.
- (3) V_{OUT} was tested on a PCB with input and output bypassing capacitors of 0.1 μF and 120 μF, respectively.

8.3 Recommended Operating Conditions

over operating free-air temperature range (unless otherwise noted)

		MIN	NOM	MAX	UNIT
V _{IN}	Input voltage	4.5		5.5	V
V _{EN}	Input voltage, EN	0		5.5	V
V _{IH}	High-level Input voltage, EN	2			V
V _{IL}	Low-level Input voltage, EN			0.7	V
C _{IN}	Input de-coupling capacitance, IN to GND	0.1			μF
I _{OUT} ⁽¹⁾	Continuous output current (TPD3S014)			0.5	A
	Continuous output current (TPD3S044)			1.5	
T _J	Operating junction temperature	-40		125	°C

- (1) Package and current ratings may require an ambient temperature derating of 85°C

8.4 Thermal Information

THERMAL METRIC ⁽¹⁾⁽²⁾		TPD3S0x4		UNIT
		DBV		
		6 PINS		
R _{θJA}	Junction-to-ambient thermal resistance	185.8		°C/W
R _{θJC(top)}	Junction-to-case (top) thermal resistance	124.7		
R _{θJB}	Junction-to-board thermal resistance	32.0		
Ψ _{JT}	Junction-to-top characterization parameter	23.7		
Ψ _{JB}	Junction-to-board characterization parameter	31.5		
R _{θJC(bot)}	Junction-to-case (bottom) thermal resistance	N/A		
R _{θJA(Custom)}	See the Power Dissipation and Junction Temperature section	120.3		

(1) For more information about traditional and new thermal metrics, see the *IC Package Thermal Metrics* application report, [SPRA953](#).

(2) See Device Comparison Table.

8.5 Electrical Characteristics: T_J = T_A = 25°C

Unless otherwise noted: V_{IN} = 5 V, V_{EN} = V_{IN}, I_{OUT} = 0 A. See [Device Comparison](#) for the rated current of each part number. Parametrics over a wider operational range are shown in the second [Electrical Characteristics: -40°C ≤ T_J ≤ 125°C](#) table.

PARAMETER		TEST CONDITIONS ⁽¹⁾	MIN	TYP	MAX	UNIT
POWER SWITCH						
R _{DS(on)}	Input – Output resistance	TPD3S014		97	110	mΩ
		TPD3S014: -40°C ≤ (T _J , T _A) ≤ 85°C		96	130	
		TPD3S044		74	91	
		TPD3S044: -40°C ≤ (T _J , T _A) ≤ 85°C		74	106	
CURRENT LIMIT						
I _{OS} ⁽²⁾	Current limit, see Figure 27	TPD3S014	0.67	0.85	1.01	A
		TPD3S044	1.70	2.15	2.50	
SUPPLY CURRENT						
I _{SD}	Supply current, switch disabled	I _{OUT} = 0 A		0.02	1	μA
		-40°C ≤ (T _J , T _A) ≤ 85°C, V _{IN} = 5.5 V, I _{OUT} = 0 A			2	
I _{SE}	Supply current, switch enabled	I _{OUT} = 0 A		66	74	μA
		-40°C ≤ (T _J , T _A) ≤ 85°C, V _{IN} = 5.5 V, I _{OUT} = 0 A			85	
I _{REV}	Reverse leakage current	V _{OUT} = 5 V, V _{IN} = 0 V, Measure I _{VOUT}		0.2	1	μA
		-40°C ≤ (T _J , T _A) ≤ 85°C, V _{OUT} = 5 V, V _{IN} = 0 V, measure I _{VOUT}			5	
OUTPUT DISCHARGE						
R _{PD}	Output pull-down resistance ⁽³⁾	V _{IN} = V _{OUT} = 5 V, disabled	400	456	600	Ω
ESD PROTECTION						
ΔC _{IO}	Differential capacitance between the D1, D2 lines	f = 1 MHz, V _{IO} = 2.5 V		0.02		pF
C _{IO}	(D1, D2 to GND)	f = 1 MHz, V _{IO} = 2.5 V		1.4		pF
R _{DYN}	Dynamic on-resistance D1, D2 IEC clamps ⁽⁴⁾	Dx to GND		0.2		Ω
		GND to Dx				

(1) Pulsed testing techniques maintain junction temperature approximately equal to ambient temperature

(2) See [Current Limit](#) for explanation of this parameter.

(3) These Parameters are provided for reference only, and do not constitute a part of TI's published device specifications for purposes of TI's product warranty.

(4) RDYN was extracted using the least squares first of the TLP characteristics between I = 20A and I = 30A.

8.6 Electrical Characteristics: $-40^{\circ}\text{C} \leq T_J \leq 125^{\circ}\text{C}$

Unless otherwise noted: $4.5\text{ V} \leq V_{\text{IN}} \leq 5.5\text{ V}$, $V_{\text{EN}} = V_{\text{IN}}$, $I_{\text{OUT}} = 0\text{ A}$, typical values are at 5 V and 25°C . See the [Device Comparison](#) for the rated current of each part number.

PARAMETER		TEST CONDITIONS ⁽¹⁾	MIN	TYP	MAX	UNIT
POWER SWITCH						
$R_{\text{DS(on)}}$	Input – output resistance	TPD3S014		97	154	m Ω
		TPD3S044		74	121	
ENABLE INPUT (EN)						
	Threshold	Input rising	1	1.45	2	V
	Hysteresis			0.13		V
	Leakage current	$V_{\text{EN}} = 0\text{ V}$	-1	0	1	μA
t_{ON}	Turn on time	$V_{\text{IN}} = 5\text{ V}$, $C_L = 1\text{ }\mu\text{F}$, $R_L = 100\text{ }\Omega$, EN \uparrow See Figure 26	1	1.6	2.2	ms
t_{OFF}	Turn off time	$V_{\text{IN}} = 5\text{ V}$, $C_L = 1\text{ }\mu\text{F}$, $R_L = 100\text{ }\Omega$, EN \downarrow See Figure 26	1.7	2.1	2.7	ms
t_{R}	Rise time, output	$C_L = 1\text{ }\mu\text{F}$, $R_L = 100\text{ }\Omega$, $V_{\text{IN}} = 5\text{ V}$, See Figure 25	0.4	0.64	0.9	ms
t_{F}	Fall time, output	$C_L = 1\text{ }\mu\text{F}$, $R_L = 100\text{ }\Omega$, $V_{\text{IN}} = 5\text{ V}$, See Figure 25	0.25	0.4	0.8	ms
CURRENT LIMIT						
$I_{\text{OS}}^{(2)}$	Current limit, see Figure 27	TPD3S014	0.65	0.85	1.05	A
		TPD3S044	1.60	2.15	2.70	
t_{IOS}	Short-circuit response time ⁽³⁾	$V_{\text{IN}} = 5\text{ V}$ (see Figure 27) One Half full load $\rightarrow R_{\text{SHORT}} = 50\text{ m}\Omega$ Measure from application to when current falls below 120% of final value		2		μs
SUPPLY CURRENT						
I_{SD}	Supply current, switch disabled	$I_{\text{OUT}} = 0\text{ A}$		0.02	10	μA
I_{SE}	Supply current, switch enabled	$I_{\text{OUT}} = 0\text{ A}$		66	94	μA
I_{REV}	Reverse leakage current	$V_{\text{OUT}} = 5.5\text{ V}$, $V_{\text{IN}} = 0\text{ V}$, Measure I_{VOUT}		0.2	20	μA
UNDERVOLTAGE LOCKOUT						
V_{UVLO}	Rising threshold	$V_{\text{IN}}\uparrow$	3.5	3.77	4	V
	Hysteresis	$V_{\text{IN}}\downarrow$		0.14		V
OUTPUT DISCHARGE						
R_{PD}	Output pull-down resistance	$V_{\text{IN}} = 4\text{ V}$, $V_{\text{OUT}} = 5\text{ V}$, Disabled	350	545	1200	Ω
		$V_{\text{IN}} = 5\text{ V}$, $V_{\text{OUT}} = 5\text{ V}$, Disabled	300	456	800	
THERMAL SHUTDOWN						
T_{SHDN}	Rising threshold (T_J)	In current limit	135			$^{\circ}\text{C}$
		Not in current limit	155			
	Hysteresis ⁽³⁾			20		$^{\circ}\text{C}$
ESD PROTECTION						
I_{I}	Input leakage current (D1, D2)	$V_{\text{I}} = 3.3\text{ V}$		0.02	1	μA
V_{D}	Diode forward voltage (D1, D2); Lower clamp diode	$I_{\text{O}} = 8\text{ mA}$			0.95	V
V_{BR}	Breakdown voltage (D1, D2)	$I_{\text{BR}} = 1\text{ mA}$	6			V

(1) Pulsed testing techniques maintain junction temperature approximately equal to ambient temperature

(2) See [Current Limit](#) section for explanation of this parameter.

(3) These parameters are provided for reference only, and do not constitute part of TI's published device specifications for purposes of TI's product warranty.

8.7 Typical Characteristics

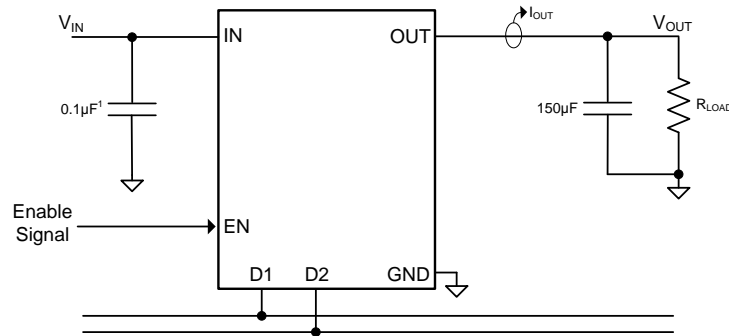

(1) During the short applied tests, 300µF is used because of the use of an external supply.

Figure 1. Test Circuit for System Operation in Typical Characteristics

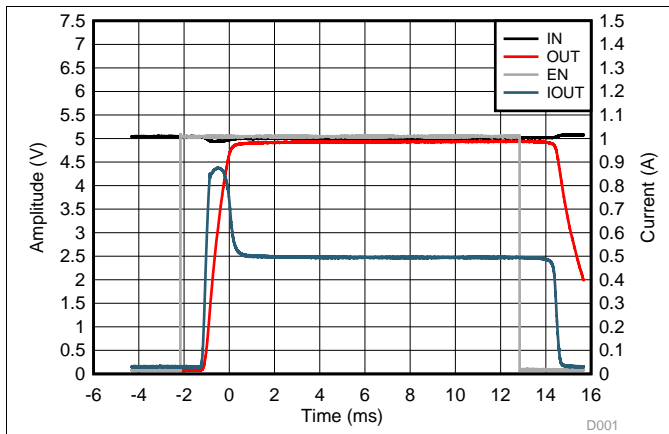

Figure 2. TPD3S014 Turn ON Into 10Ω

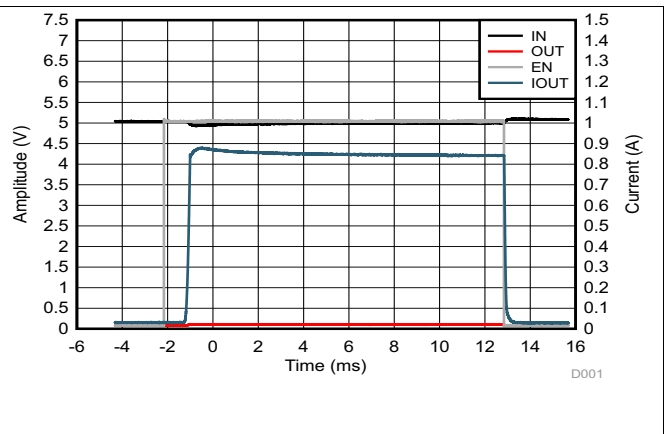

Figure 3. TPD3S014 Enable into Short

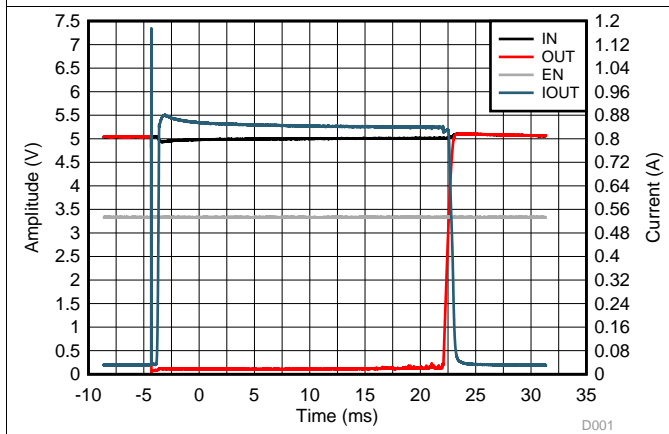

Figure 4. TPD3S014 Pulsed Output Short

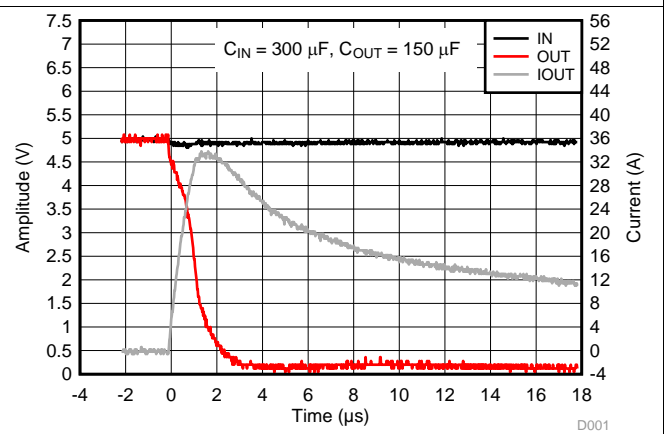

Figure 5. TPD3S014 Short Applied

Typical Characteristics (continued)

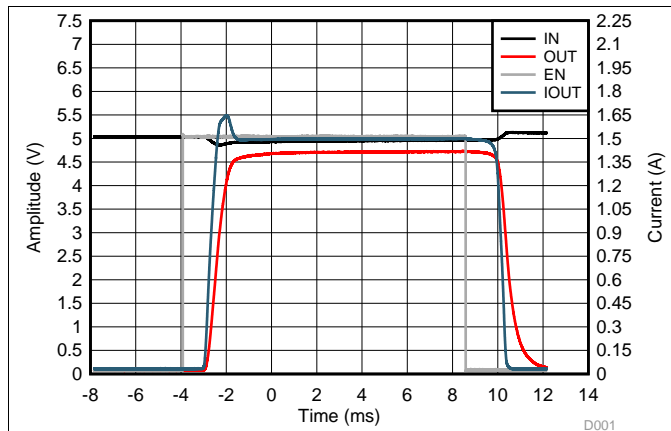

Figure 6. TPD3S044 Turn ON Into 3.3Ω

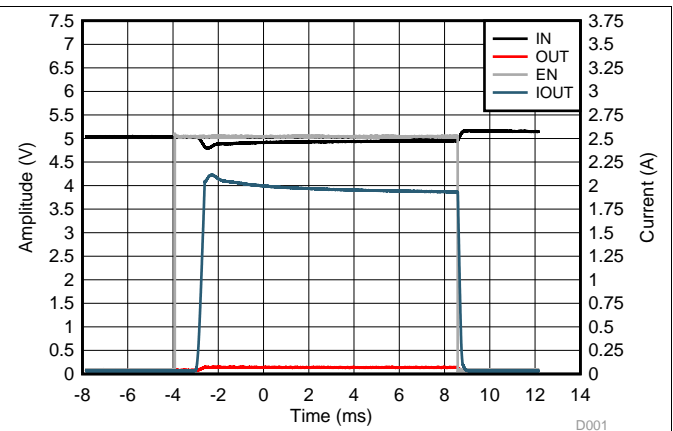

Figure 7. TPD3S044 Enable Into Short

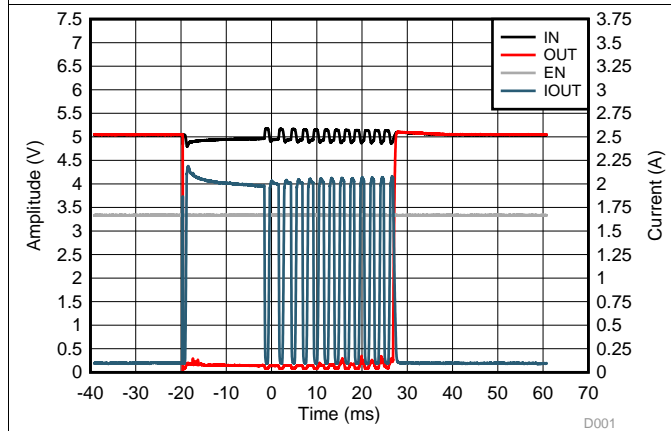

Figure 8. TPD3S044 Pulsed Output Short

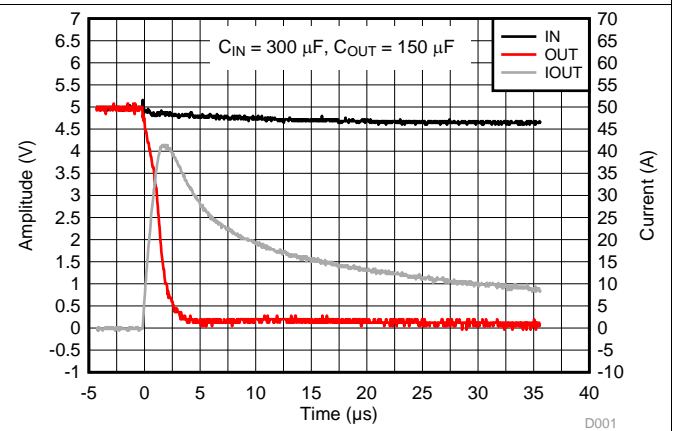

Figure 9. TPD3S044 Short Applied

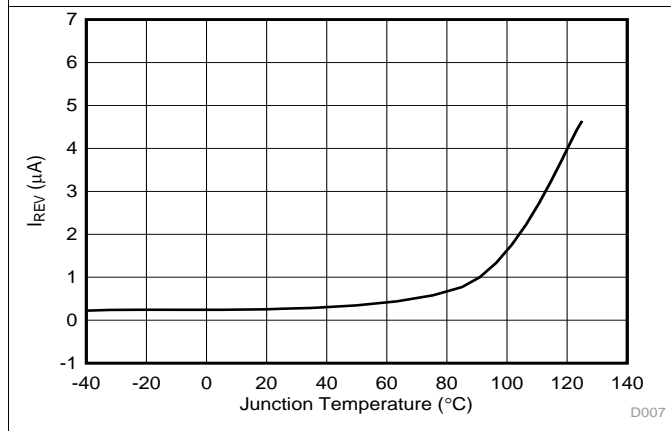

Figure 10. Reverse Leakage Current (I_{REV}) vs Temperature

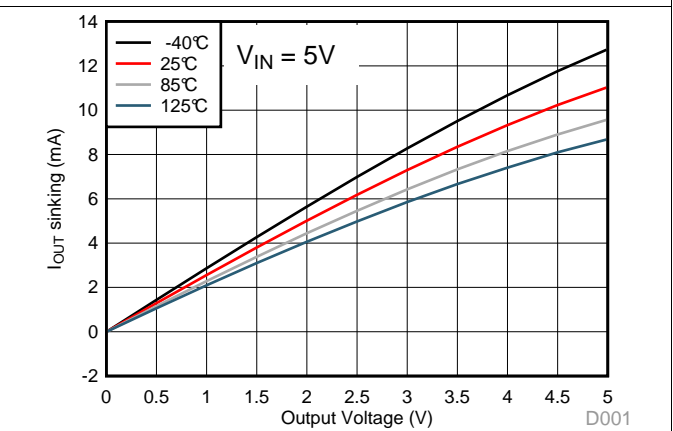

Figure 11. Output Discharge Current vs Output Voltage

Typical Characteristics (continued)

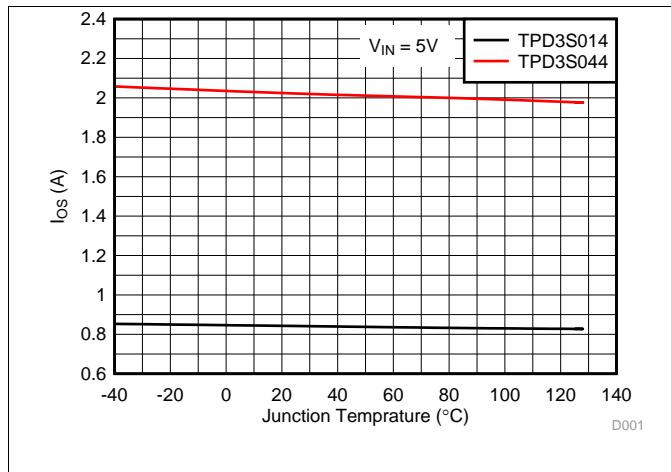

Figure 12. Short Circuit Current (I_{OS}) vs Temperature

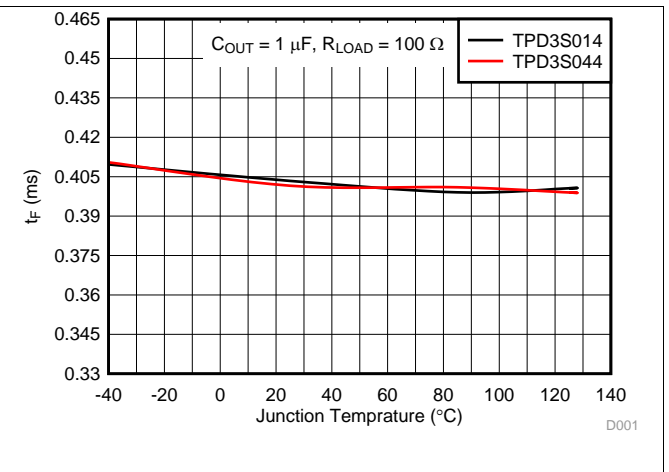

Figure 13. Output Fall Time (t_F) vs Temperature

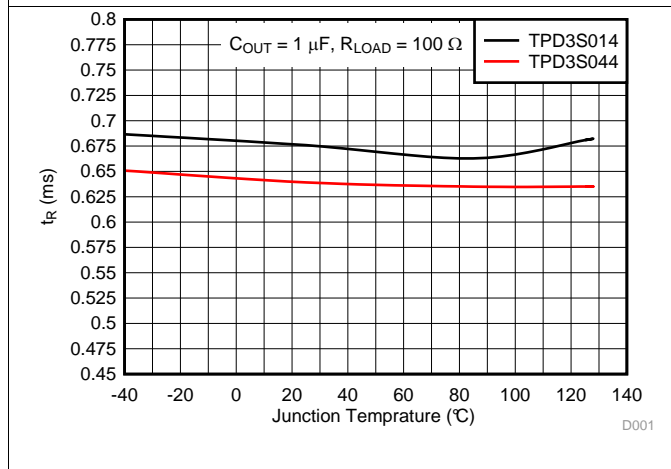

Figure 14. Output Rise Time (t_R) vs Temperature

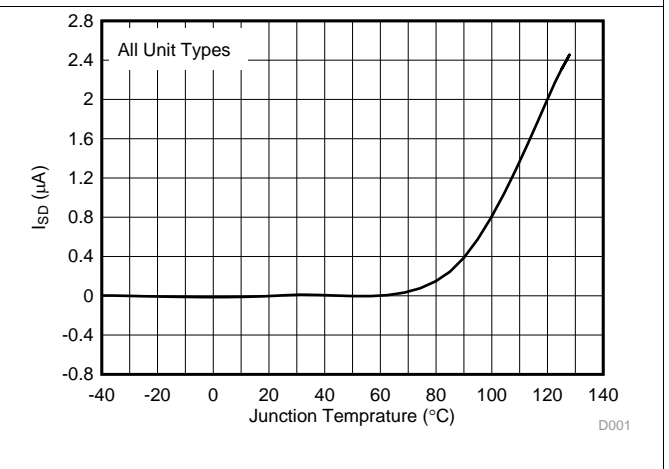

Figure 15. Disabled Supply Current (I_{SD}) vs Temperature

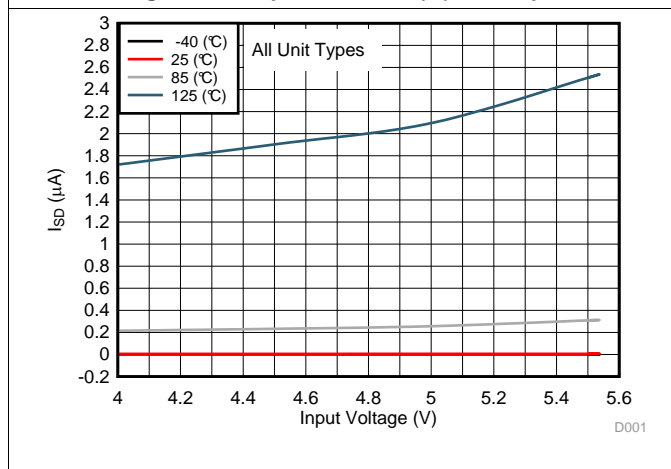

Figure 16. Disabled Supply Current (I_{SD}) vs Input Voltage

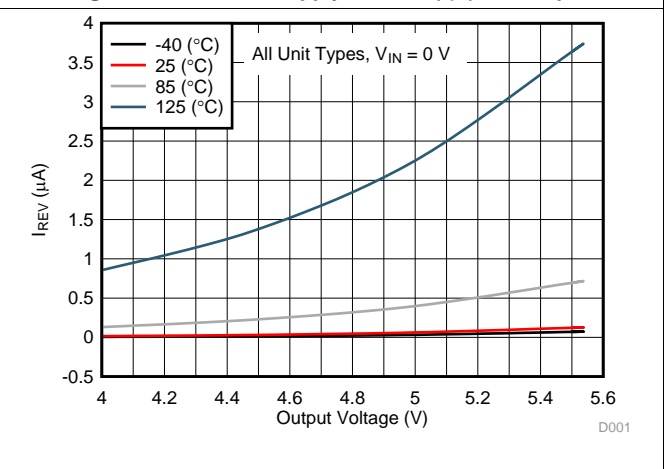

Figure 17. Reverse Leakage Current (I_{REV}) vs Output Voltage

Typical Characteristics (continued)

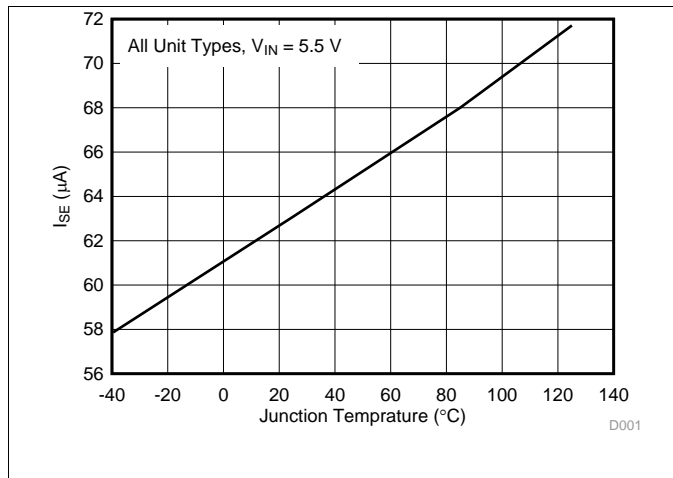

Figure 18. Enabled Supply Current (I_{SE}) vs Temperature

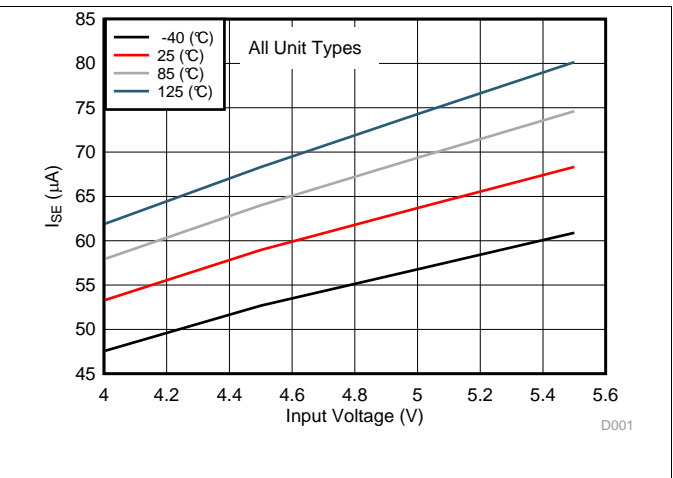

Figure 19. Enabled Supply Current (I_{SE}) vs Input Voltage

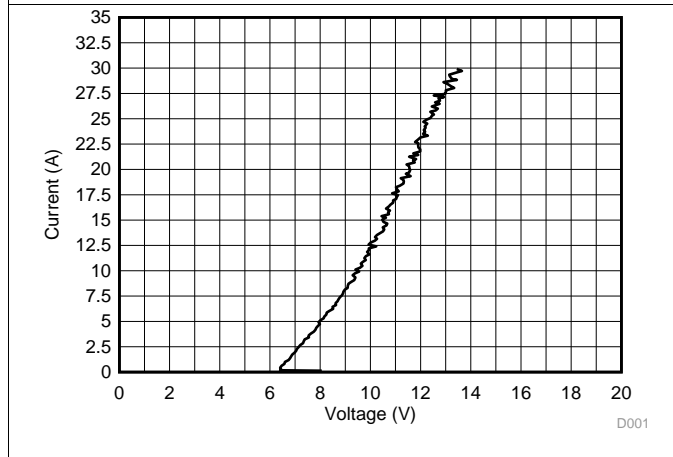

Figure 20. TPD3S044 D1/D2 Positive TLP Curve

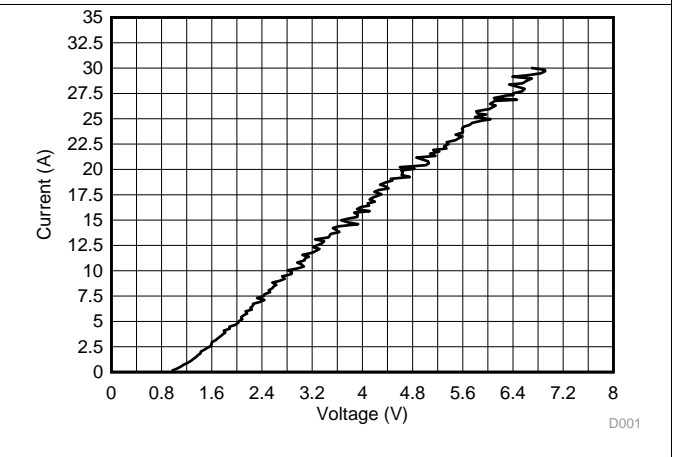

Figure 21. TPD3S044 D1/D2 Negative TLP Curve

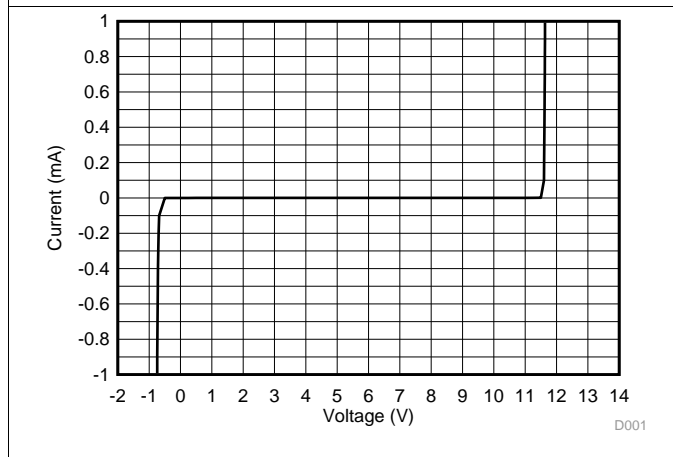

Figure 22. D1/D2 I-V Curve

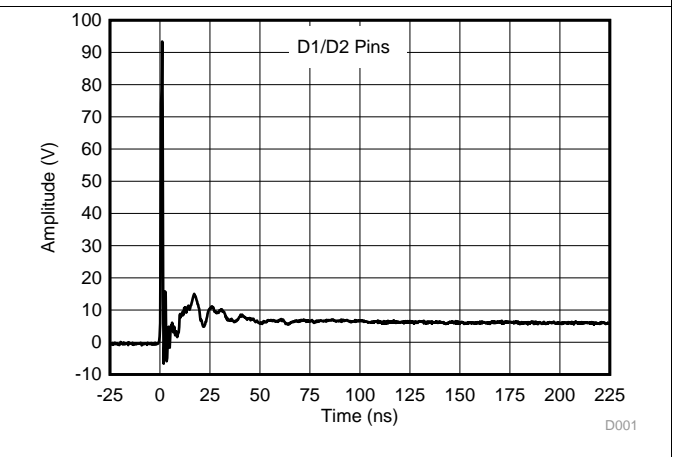

Figure 23. D1/D2 IEC61000-4-2 +8-kV Contact

Typical Characteristics (continued)

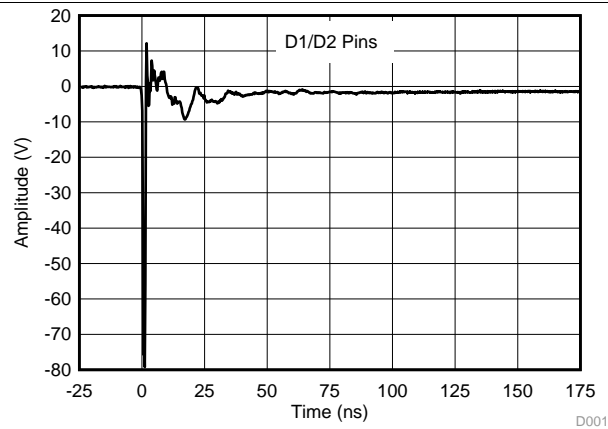

Figure 24. D1/D2 IEC61000-4-2 –8-kV Contact

9 Detailed Description

9.1 Overview

The TPD3S0x4 are highly integrated devices that feature a current limited load switch and a two channel Transient Voltage Suppressor (TVS) based Electrostatic Discharge (ESD) protection diode array for USB interfaces. The TPD3S014 and TPD3S044 provide 0.5 A and 1.5 A, respectively, of continuous load current in 5-V circuits. These parts use N-channel MOSFETs for low resistance, maintaining voltage regulation to the load. It is designed for applications where short circuits or heavy capacitive loads will be encountered. Device features include enable, reverse blocking when disabled, output discharge pull-down, over-current protection, and over-temperature protection. Finally, with two channels of TVS ESD protection diodes integrated, TPD3S0x4s provide system level ESD protection to all the pins of the USB port.

9.2 Functional Block Diagram

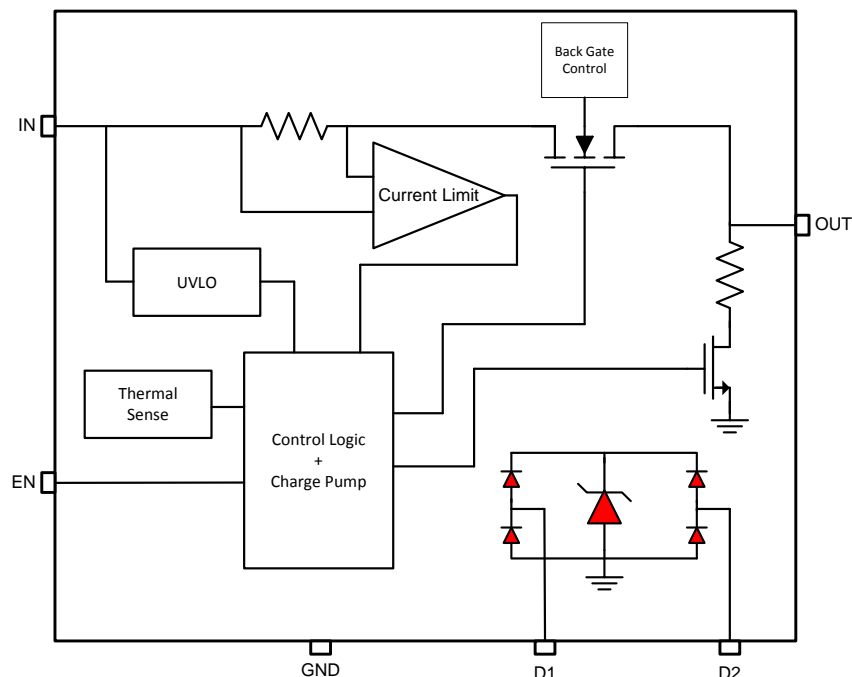

9.3 Feature Description

9.3.1 Undervoltage Lockout (UVLO)

The UVLO circuit disables the power switch until the input voltage reaches the UVLO turn-on threshold. Built-in hysteresis prevents unwanted on/off cycling due to input voltage drop from large current surges.

9.3.2 Enable

The logic enable input (EN) controls the power switch, bias for the charge pump, driver, and other circuits. The supply current is reduced to less than 1 μA when the TPD3S0x4s are disabled. The enable input is compatible with both TTL and CMOS logic levels.

The turn on and turn off times (t_{ON} , t_{OFF}) are composed of a delay and a rise or fall time (t_{R} , t_{F}). The delay times are internally controlled. The rise time is controlled by both the TPD3S0x4s and the external loading (especially capacitance). TPD3S0x4s fall time is controlled by the loading (R and C), and the output discharge (R_{PD}). An output load consisting of only a resistor will experience a fall time set by the TPD3S0x4s. An output load with parallel R and C elements will experience a fall time determined by the (R \times C) time constant if it is longer than the TPD3S0x4's t_{F} . Please see [Figure 25](#) and [Figure 26](#) for a pictorial description of t_{R} , t_{F} , t_{ON} , and t_{OFF} . The enable should not be left open; it may be tied to VIN.

Feature Description (continued)

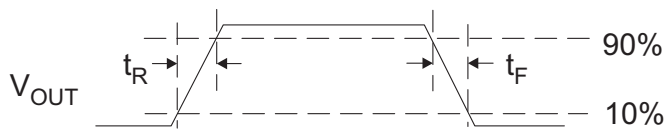

Figure 25. Power-On and Power-Off Timing

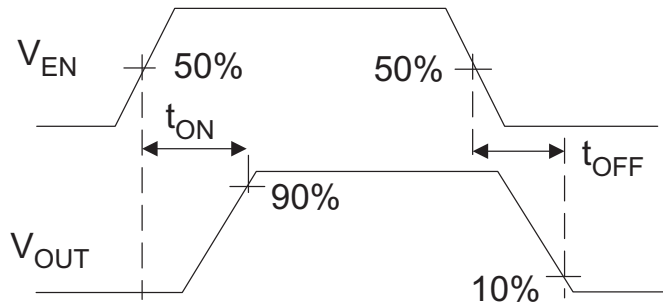

Figure 26. Enable Timing, Active-High Enable

9.3.3 Internal Charge Pump

The device incorporates an internal charge pump and gate drive circuitry necessary to drive the N-channel MOSFET. The charge pump supplies power to the gate driver circuit and provides the necessary voltage to pull the gate of the MOSFET above the source. The driver incorporates circuitry that controls the rise and fall times of the output voltage to limit large current and voltage surges on the input supply, and provides built-in soft-start functionality. The MOSFET power switch will block current from OUT to IN when turned off by the UVLO or disabled.

9.3.4 Current Limit

The TPD3S0x4s respond to overloads by limiting output current to the static current-limit (IOS) levels shown in the *Electrical Characteristics: T_J = T_A = 25°C* table. When an overload condition is present, the device maintains a constant output current, with the output voltage determined by (I_{OS} × R_{LOAD}). Two possible overload conditions can occur.

The first overload condition occurs when either:

1. The input voltage is first applied, enable is true, and a short circuit is present (load which draws I_{OUT} > I_{OS}) or
2. The input voltage is present and the TPD3S0x4s are enabled into a short circuit.

The output voltage is held near zero potential with respect to ground and the TPD3S0x4s ramp the output current to I_{OS}. The TPD3S0x4s will limit the current to I_{OS} until the overload condition is removed or the device begins to thermal cycle. The device subsequently cycles current off and on as the thermal protection engages.

The second condition is when an overload occurs while the device is enabled and fully turned on. The device responds to the overload condition within t_{IOS} (Figure 27 and Figure 28) when the specified overload (per Electrical Characteristics table) is applied. The response speed and shape will vary with the overload level, input circuit, and rate of application. The current-limit response will vary between simply settling to I_{OS}, or turnoff and controlled return to I_{OS}. Similar to the previous case, the TPD3S0x4s will limit the current to I_{OS} until the overload condition is removed or the device begins to thermal cycle.

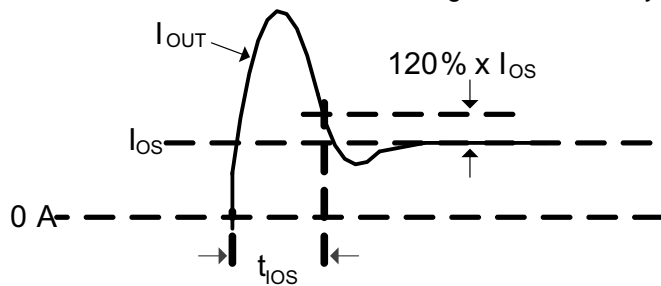

Figure 27. Output Short Circuit Parameters

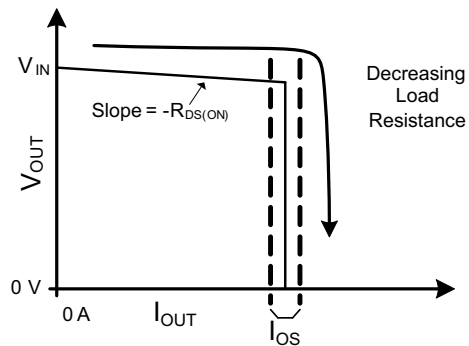

Figure 28. Output Characteristic Showing Current Limit

Feature Description (continued)

The TPD3S0x4s thermal cycle if an overload condition is present long enough to activate thermal limiting in any of the above cases. This is due to the relatively large power dissipation $[(V_{IN} - V_{OUT}) \times I_{OS}]$ driving the junction temperature up. The devices turn off when the junction temperature exceeds 135°C (min) while in current limit. The devices remains off until the junction temperature cools 20°C and then restarts.

There are two kinds of current limit profiles typically available in TI switch products similar to the TPD3S0x4s. Many older designs have an output I vs V characteristic similar to the plot labeled "Current Limit with Peaking" in Figure 29. This type of limiting can be characterized by two parameters, the current limit corner (I_{OC}), and the short circuit current (I_{OS}). I_{OC} is often specified as a maximum value. The TPD3S0x4 parts do not present noticeable peaking in the current limit, corresponding to the characteristic labeled "Flat Current Limit" in Figure 29. This is why the I_{OC} parameter is not present in the *Electrical Characteristics* tables.

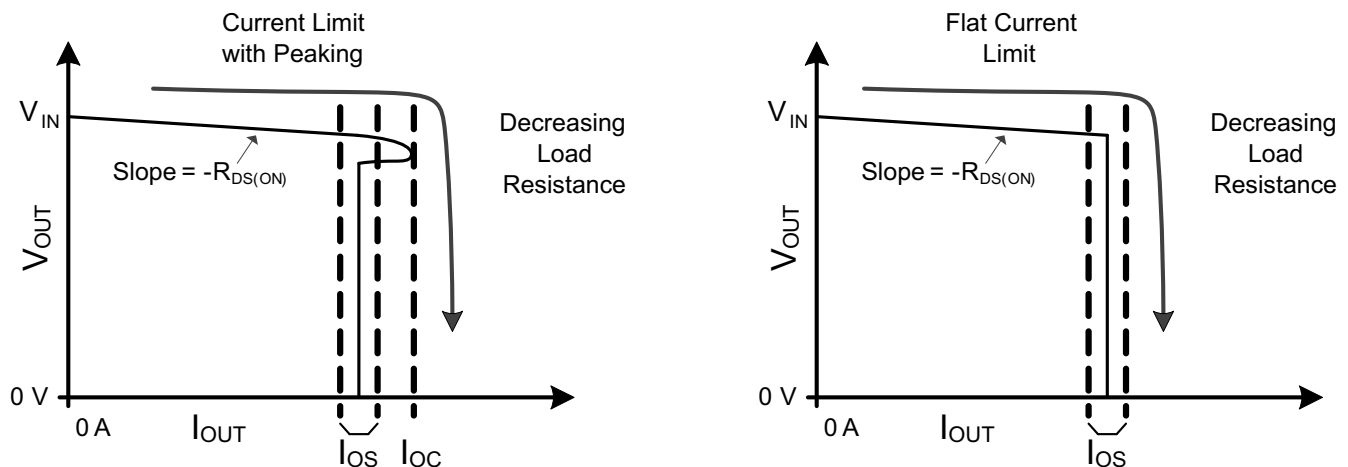

Figure 29. Current Limit Profiles

9.3.5 Output Discharge

A 470- Ω (typical) output discharge resistance will dissipate stored charge and leakage current on OUT when the TPD3S0x4s are in UVLO or disabled. The pull-down circuit will lose bias gradually as V_{IN} decreases, causing a rise in the discharge resistance as V_{IN} falls towards 0 V.

9.3.6 Input and Output Capacitance

Input and output capacitance improves the performance of the device; the actual capacitance should be optimized for the particular application. For all applications, a 0.1 μF or greater ceramic bypass capacitor between IN and GND is recommended as close to the device as possible for local noise decoupling.

All protection circuits such as the TPD3S0x4s will have the potential for input voltage overshoots and output voltage undershoots.

Input voltage overshoots can be caused by either of two effects. The first cause is an abrupt application of input voltage in conjunction with input power bus inductance and input capacitance when the IN terminal is high impedance (before turn on). Theoretically, the peak voltage is 2 times the applied. The second cause is due to the abrupt reduction of output short circuit current when the TPD3S0x4s turn off and energy stored in the input inductance drives the input voltage high. Input voltage droops may also occur with large load steps and as the TPD3S0x4s outputs are shorted. Applications with large input inductance (for example, connecting the evaluation board to the bench power-supply through long cables) may require large input capacitance reduce the voltage overshoot from exceeding the absolute maximum voltage of the device. The fast current-limit speed of the TPD3S0x4s to hard output short circuits isolates the input bus from faults. However, ceramic input capacitance in the range of 1 to 22 μF adjacent to the TPD3S0x4s inputs aids in both speeding the response time and limiting the transient seen on the input power bus. Momentary input transients to 6.5 V are permitted.

Feature Description (continued)

Output voltage undershoot is caused by the inductance of the output power bus just after a short has occurred and the TPD3S0x4s have abruptly reduced OUT current. Energy stored in the inductance will drive the OUT voltage down and potentially negative as it discharges. Applications with large output inductance (such as from a cable) benefit from use of a high-value output capacitor to control the voltage undershoot. When implementing USB standard applications, a 120 µF minimum output capacitance is required. Typically a 150-µF electrolytic capacitor is used, which is sufficient to control voltage undershoots. However, if the application does not require 120 µF of capacitance, and there is potential to drive the output negative, a minimum of 10-µF ceramic capacitance on the output is recommended. The voltage undershoot should be controlled to less than 1.5 V for 10 µs.

9.3.7 Power Dissipation and Junction Temperature

It is good design practice to estimate power dissipation and maximum expected junction temperature of the TPD3S0x4s. The system designer can control choices of the devices proximity to other power dissipating devices and printed circuit board (PCB) design based on these calculations. These have a direct influence on maximum junction temperature. Other factors, such as airflow and maximum ambient temperature, are often determined by system considerations. It is important to remember that these calculations do not include the effects of adjacent heat sources, and enhanced or restricted air flow. Addition of extra PCB copper area around these devices is recommended to reduce the thermal impedance and maintain the junction temperature as low as practical. In particular, connect the GND pin to a large ground plane for the best thermal dissipation. The following PCB layout example [Figure 30](#) was used to determine the $R_{\theta JA}$. Custom thermal impedances noted in the [Thermal Information](#) table. It is based on the use of the JEDEC high-k circuit board construction with 4, 1 oz. copper weight layers (2 signal and 2 plane).

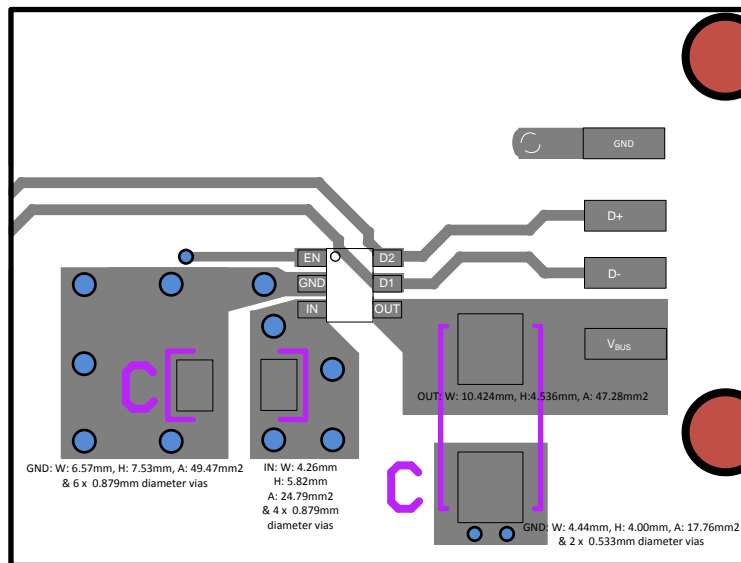

Figure 30. PCB Layout Example

The following procedure requires iteration because power loss is due to the internal MOSFET $I^2 \times R_{DS(ON)}$, and $R_{DS(ON)}$ is a function of the junction temperature. As an initial estimate, use the $R_{DS(ON)}$ at 125°C from the [Typical Characteristics](#), and the preferred package thermal resistance for the preferred board construction from the [Thermal Information](#) table.

$$T_J = T_A + [(I_{OUT}^2 \times R_{DS(ON)}) \times R_{\theta JA}]$$

where

- I_{OUT} = rated OUT pin current (A)
- $R_{DS(ON)}$ = Power switch on-resistance at an assumed T_J (Ω)
- T_A = Maximum ambient temperature ($^{\circ}\text{C}$)
- T_J = Maximum junction temperature ($^{\circ}\text{C}$)
- $R_{\theta JA}$ = Thermal resistance ($^{\circ}\text{C}/\text{W}$)

(1)

Feature Description (continued)

If the calculated T_J is substantially different from the original assumption, estimate a new value of $R_{DS(ON)}$ using the typical characteristic plot and recalculate.

If the resulting T_J is not less than 125°C, try a PCB construction with a lower $R_{\theta JA}$. Please find the junction temperature derating curve based on the TI standard reliability duration in [Figure 31](#).

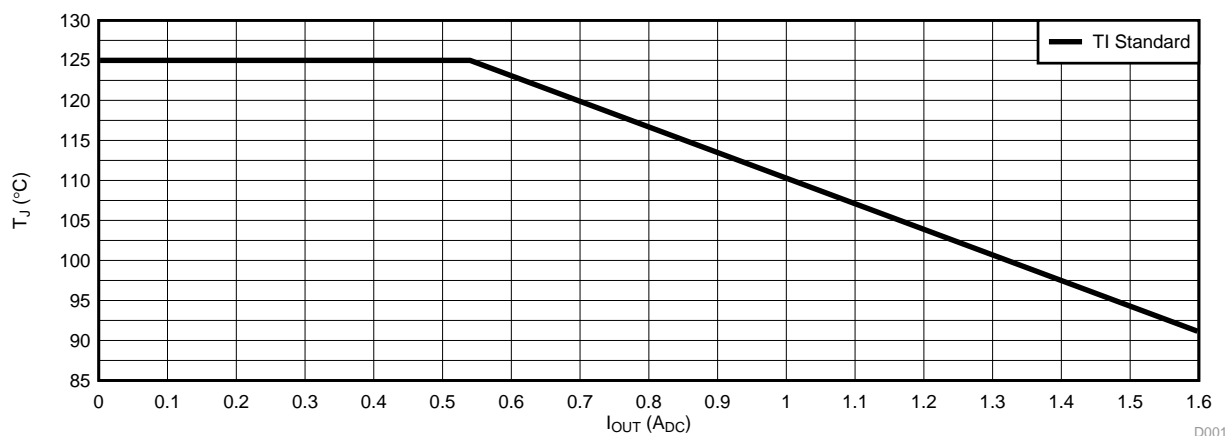

Figure 31. Junction Temperature Derating Curve

9.4 Device Functional Modes

9.4.1 Operation with $V_{IN} < 4$ V (Minimum V_{IN})

These devices operate with input voltages above 4V. The maximum UVLO voltage on IN is 4V and the devices will operate at input voltages above 4 V. Any voltage below 4 V may not work with these devices. The minimum UVLO is 3.5 V, so some devices may work between 3.5 V and 4 V. At input voltages below the actual UVLO voltage, these devices will not operate.

9.4.2 Operation With EN Control

The enable rising edge threshold voltage is 1.45 V typical and 2 V maximum. With EN held below that voltage the device is disabled and the load switch will be open. The IC quiescent current is reduced in this state. When the EN pin is above its rising edge threshold and the input voltage on the IN pin is above its UVLO threshold, the device becomes active. The load switch is closed, and the current limit feature is enabled. The output voltage on OUT will ramp up with the soft start value T_{ON} in order to prevent large inrush current surges on V_{BUS} due to a heavy capacitive load. When EN voltage is lowered below its falling edge threshold, the device output voltage will also ramp down with soft turn off value T_{OFF} to prevent large inductive voltages being presented to the system in the case a large load current is following through the device.

9.4.3 Operation of Level 4 IEC61000-4-2 ESD Protection

Regardless of which functional mode the devices are in, TPD3S0x4 will provide Level 4 IEC61000-4-2 ESD Protection on the pins of the USB connector.

10 Application and Implementation

NOTE

Information in the following applications sections is not part of the TI component specification, and TI does not warrant its accuracy or completeness. TI's customers are responsible for determining suitability of components for their purposes. Customers should validate and test their design implementation to confirm system functionality.

10.1 Application Information

TPD3S0x4 are devices that feature a current limited load switch and a two channel Transient Voltage Suppressor (TVS) based Electrostatic Discharge (ESD) protection diode array. They are typically used to provide a complete protection solution for USB host ports. USB host ports are required by the USB specification to provide a current limit on the VBUS path in order to protect the system from over-current conditions on the port that could lead to system damage and user injury. Additionally, USB ports typically require system level IEC ESD protection due to direct end-user interaction. The following design procedure can be used to determine how to properly implement TPD3S0x4s in your systems to provide a complete, one-chip solution for your USB ports.

10.2 Typical Application

10.2.1 USB2.0 Application

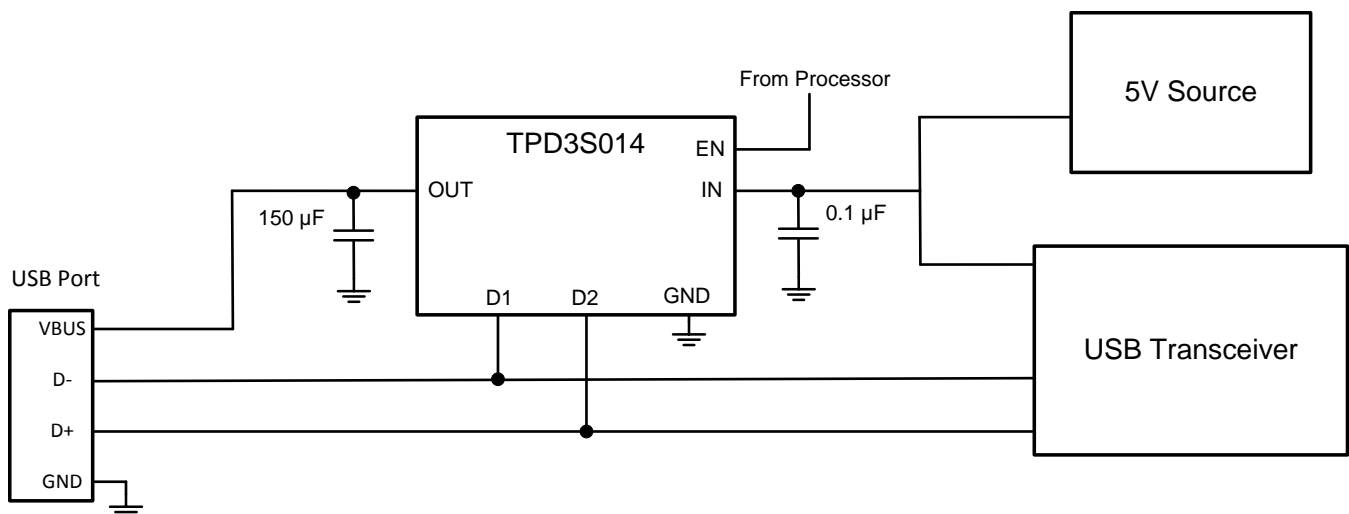

Figure 32. USB2.0 Application Schematic

10.2.1.1 Design Requirements

For this design example, use the following as the system parameters.

DESIGN PARAMETER	VALUE
USB Port Type	Standard Downstream Port
Signal Voltage Range on V _{BUS}	0 V to 5.25 V
Current Range on V _{BUS}	0 mA to 500 mA
Maximum Voltage Droop Allowed on Adjacent USB Port	330 mV
Maximum Data Rate	480 Mbps

10.2.1.2 Detailed Design Procedure

To properly implement your USB port with TPD3S0x4s, the first step is to determine what type of USB port you are implementing in your system, whether it be a Standard Downstream Port (SDP), Charging Downstream Port (CDP), or Dedicated Charging Port (DCP); this will inform you what your maximum continuous operating current will be on VBUS. In our example, we are implementing an SDP port, so the maximum continuous current allowed to be pulled by a device is 500mA. Therefore, we need to choose a current limit switch that is 5.25V tolerant, can handle 500mA continuous DC current, and has a current limit point is above 500 mA so it will not current limit during normal operation. TPD3S014 is therefore the best choice for this application, as it has these features, and in fact was specifically designed for this application.

The next decision point is choosing your input and output capacitors for your current limit switch. A minimum of 0.1 μF is always recommended on the IN pin. For the OUT pin on VBUS, USB standard requires a minimum of 120 μF ; typically a 150 μF capacitor is used. The purpose of the capacitance requirement on the VBUS line in the USB specification is to prevent the adjacent USB port's VBUS voltage from dropping more than 330 mV during a hot-plug or fault occurrence on the VBUS pin of one USB port. Hot-plugs and fault conditions on one USB port should not disturb the normal operation of an adjacent USB port; therefore, it is possible to use an output capacitance lower than 120 μF if your system is able to keep voltage droops on adjacent USB ports less than or equal to 330 mV. For example, if the DC/DC powering VBUS has a fast transient response, 120 μF may not be required.

If your USB port is powered from a shared system 5V rail, a system designer may desire to use large than 0.1 μF for the input capacitor on the IN pin. This is largely dependent on your PCB layout and parasitics, as well as your maximum tolerated voltage droop on the shared rail during transients. For more information on choosing input and output capacitors, please see [Input and Output Capacitance](#) in the Detailed Description section.

The EN pin controls the on and off state of the device, and typically is connected to the system processor for power sequencing. However, the EN pin can also be shorted to the IN pin to always have the TPD3S014 on when 5V power supply on; this also saves a GPIO pin on your processor.

For a USB port with High-Speed 480Mbps operation, low capacitance TVS ESD protection diodes are required to protect the D+ and D- lines in the event of system level ESD event. TPD3S014 has 2-channels of low capacitance TVS ESD protection diodes integrated. When placed near the USB connector, TPD3S014 offers little or no signal distortion during normal operation. TPD3S014 also ensures that the core system circuitry is protected in the event of an ESD strike. PCB Layout is critical when implementing TVS ESD protection diodes in your system; please read the [Layout](#) section for proper guidelines on routing your USB lines with TPD3S014.

10.2.1.3 Application Curves

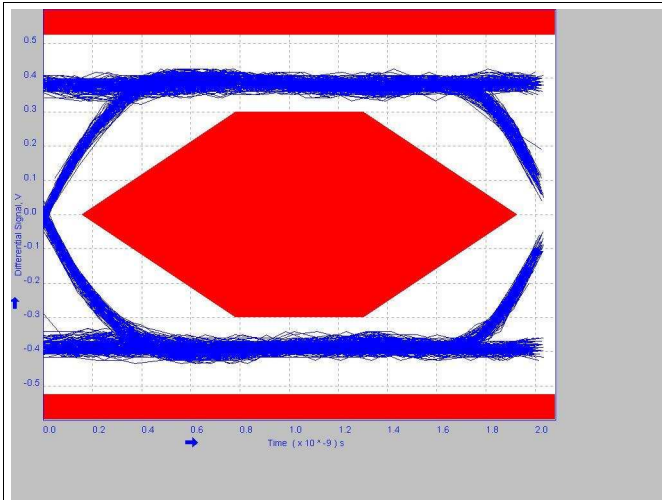

Figure 33. Eye-Diagram Without EVM

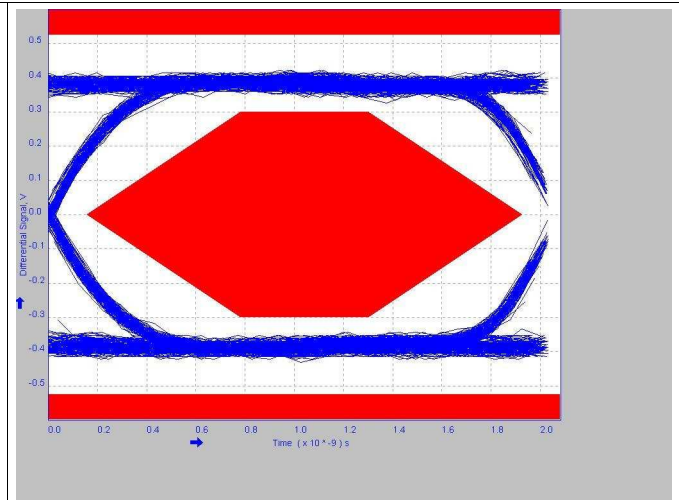

Figure 34. Eye-Diagram With EVM, Without TPD3S0x4

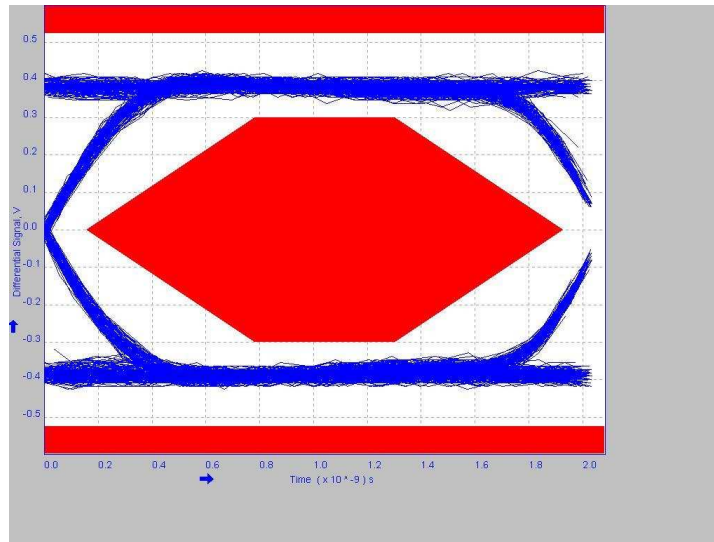

Figure 35. Eye-Diagram of TPD3S0x4 on EVM

10.2.2 USB3.0 Application

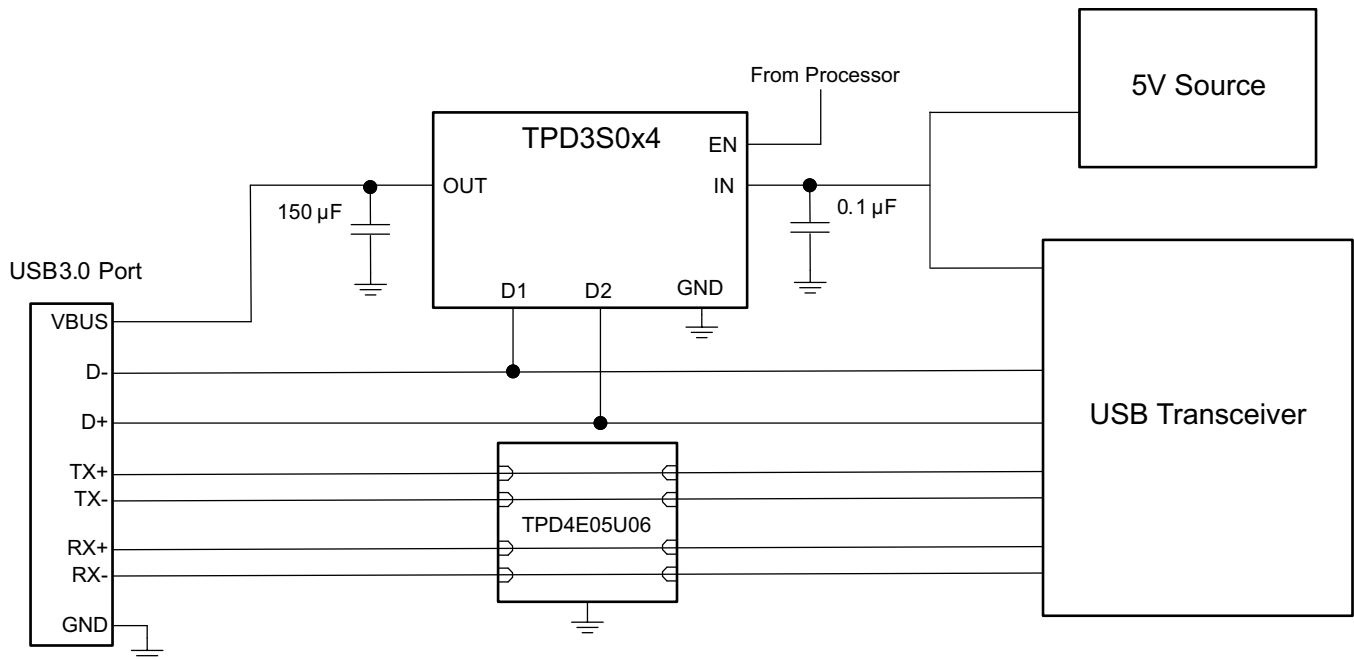

Figure 36. USB3.0 Application Schematic

10.2.2.1 Design Requirements

For this design example, use the following as the system parameters.

DESIGN PARAMETER	VALUE
USB Port Type	Standard Downstream Port
Signal Voltage Range on V_{BUS}	0 V to 5.25 V
Current Range on V_{BUS}	0 mA to 900 mA
Maximum Voltage Droop Allowed on Adjacent USB Port	330 mV
Maximum Data Rate D+, D- Lines	480 Mbps
Maximum Data Rate TX+/-, RX+/- Lines	5 Gbps

10.2.2.2 Detailed Design Procedure

The implementation of the USB3.0 port with TPD3S0x4s is identical to the USB2.0 port, except that in this use case we must use TPD3S044 because USB3.0 SDP has a maximum V_{BUS} current 900 mA. TPD3S014 current limit level is too low for USB3.0 operation. In addition to using TPD3S044, USB3.0 has four more Super-Speed Lines for transferring data 5 Gbps, and these lines also typically require Level 4 IEC61000-4-2 ESD Protection. With a data rate of 5 Gbps, ultra-low capacitance TVS ESD protection diodes are required to protect the TX+/- and RX+/- lines in the event of system level ESD event. TPD4E05U06 provides 4-channels of ultra-low capacitance TVS ESD protection diodes for USB3.0 Super-Speed lines, and can be coupled with TPD3S044 to provide a two-chip total protection solution for the USB3.0 Host Port. Please refer to the [Layout](#) section of the datasheet for guidelines on the PCB Layout of this two-chip solution.

The rest of the design procedure is identical to the [USB2.0 Application](#) section, so please refer to it for the rest of the design procedure.

10.2.2.3 Application Curves

See [Application Curves](#) for TPD3S0x4 Eye-Diagram performance. Please refer to the [TPD4E05U06](#) datasheet on ti.com to see its specifications and Eye-Diagram performance.

11 Power Supply Recommendations

These devices are designed to operate from a 5 V input voltage supply. This input should be well regulated. If the input supply is located more than a few inches away from the TPD3S0x4, additional bulk capacitance may be required in addition to the recommended minimum 0.1 μF bypass capacitor on the IN pin to keep the input rail stable during fault events.

12 Layout

12.1 Layout Guidelines

- The optimum placement is as close to the connector as possible.
 - EMI during an ESD event can couple from the trace being struck to other nearby unprotected traces, resulting in early system failures.
 - The PCB designer needs to minimize the possibility of EMI coupling by keeping any unprotected traces away from the protected traces which are between the TVS and the connector.
- Route the protected traces as straight as possible.
- Eliminate any sharp corners on the protected traces between the TVS and the connector by using rounded corners with the largest radii possible.
 - Electric fields tend to build up on corners, increasing EMI coupling.

12.2 Layout Examples

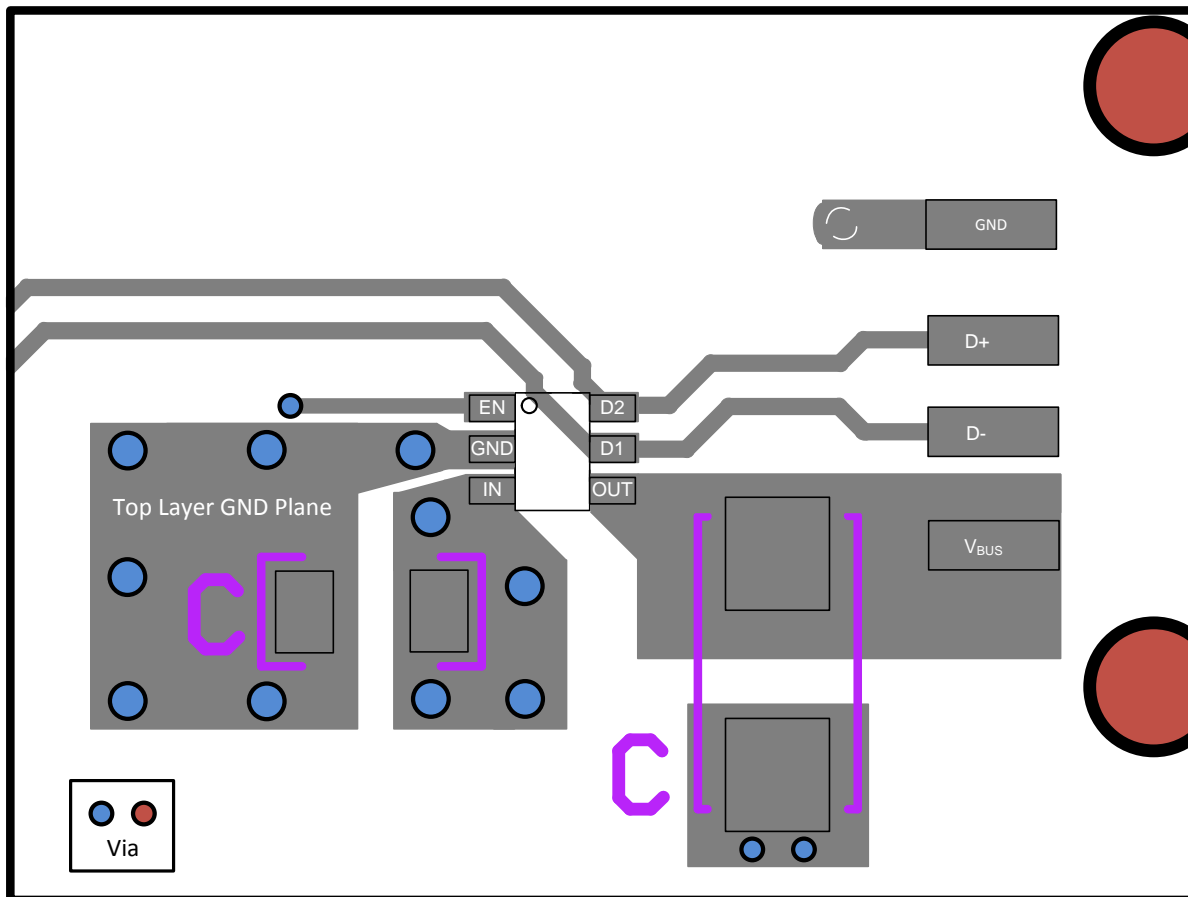

Figure 37. USB2.0 Type A TPD3S0x4 Board Layout

Layout Examples (continued)

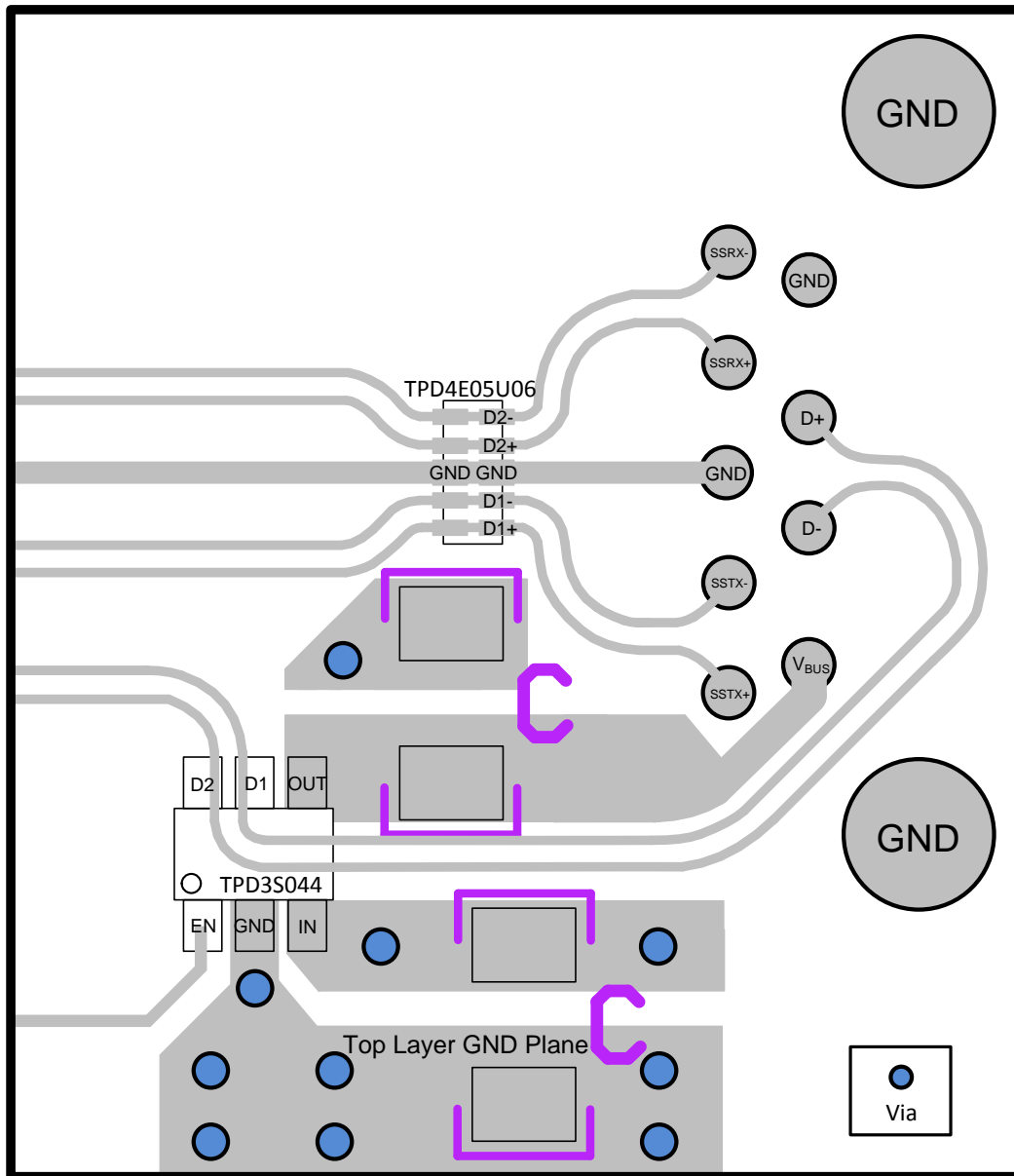

Figure 38. USB3.0 Type A TPD3S044 Board Layout

13 器件和文档支持

13.1 相关链接

以下表格列出了快速访问链接。范围包括技术文档、支持与社区资源、工具和软件，并且可以快速访问样片或购买链接。

表 1. 相关链接

器件	产品文件夹	样片与购买	技术文档	工具与软件	支持与社区
TPD3S014	请单击此处	请单击此处	请单击此处	请单击此处	请单击此处
TPD3S044	请单击此处	请单击此处	请单击此处	请单击此处	请单击此处
TPD4E05U06	请单击此处	请单击此处	请单击此处	请单击此处	请单击此处

13.2 商标

13.3 静电放电警告



这些装置包含有限的内置 ESD 保护。存储或装卸时，应将导线一起截短或将装置放置于导电泡棉中，以防止 MOS 门极遭受静电损伤。

13.4 术语表

[SLYZ022](#) — TI 术语表。

这份术语表列出并解释术语、首字母缩略词和定义。

14 机械封装和可订购信息

以下页中包括机械封装和可订购信息。这些信息是针对指定器件可提供的最新数据。这些数据会在无通知且不对本文档进行修订的情况下发生改变。欲获得该数据表的浏览器版本，请查阅左侧的导航栏。

PACKAGING INFORMATION

Orderable Device	Status (1)	Package Type	Package Drawing	Pins	Package Qty	Eco Plan (2)	Lead finish/ Ball material (6)	MSL Peak Temp (3)	Op Temp (°C)	Device Marking (4/5)	Samples
TPD3S014DBVR	ACTIVE	SOT-23	DBV	6	3000	RoHS & Green	SN	Level-1-260C-UNLIM	-40 to 85	SII	Samples
TPD3S044DBVR	ACTIVE	SOT-23	DBV	6	3000	RoHS & Green	SN	Level-1-260C-UNLIM	-40 to 85	SIJ	Samples

(1) The marketing status values are defined as follows:

ACTIVE: Product device recommended for new designs.

LIFEBUY: TI has announced that the device will be discontinued, and a lifetime-buy period is in effect.

NRND: Not recommended for new designs. Device is in production to support existing customers, but TI does not recommend using this part in a new design.

PREVIEW: Device has been announced but is not in production. Samples may or may not be available.

OBSOLETE: TI has discontinued the production of the device.

(2) **RoHS:** TI defines "RoHS" to mean semiconductor products that are compliant with the current EU RoHS requirements for all 10 RoHS substances, including the requirement that RoHS substance do not exceed 0.1% by weight in homogeneous materials. Where designed to be soldered at high temperatures, "RoHS" products are suitable for use in specified lead-free processes. TI may reference these types of products as "Pb-Free".

RoHS Exempt: TI defines "RoHS Exempt" to mean products that contain lead but are compliant with EU RoHS pursuant to a specific EU RoHS exemption.

Green: TI defines "Green" to mean the content of Chlorine (Cl) and Bromine (Br) based flame retardants meet JS709B low halogen requirements of <=1000ppm threshold. Antimony trioxide based flame retardants must also meet the <=1000ppm threshold requirement.

(3) MSL, Peak Temp. - The Moisture Sensitivity Level rating according to the JEDEC industry standard classifications, and peak solder temperature.

(4) There may be additional marking, which relates to the logo, the lot trace code information, or the environmental category on the device.

(5) Multiple Device Markings will be inside parentheses. Only one Device Marking contained in parentheses and separated by a "~" will appear on a device. If a line is indented then it is a continuation of the previous line and the two combined represent the entire Device Marking for that device.

(6) Lead finish/Ball material - Orderable Devices may have multiple material finish options. Finish options are separated by a vertical ruled line. Lead finish/Ball material values may wrap to two lines if the finish value exceeds the maximum column width.

Important Information and Disclaimer:The information provided on this page represents TI's knowledge and belief as of the date that it is provided. TI bases its knowledge and belief on information provided by third parties, and makes no representation or warranty as to the accuracy of such information. Efforts are underway to better integrate information from third parties. TI has taken and continues to take reasonable steps to provide representative and accurate information but may not have conducted destructive testing or chemical analysis on incoming materials and chemicals. TI and TI suppliers consider certain information to be proprietary, and thus CAS numbers and other limited information may not be available for release.

In no event shall TI's liability arising out of such information exceed the total purchase price of the TI part(s) at issue in this document sold by TI to Customer on an annual basis.

TAPE AND REEL INFORMATION

QUADRANT ASSIGNMENTS FOR PIN 1 ORIENTATION IN TAPE

*All dimensions are nominal

Device	Package Type	Package Drawing	Pins	SPQ	Reel Diameter (mm)	Reel Width W1 (mm)	A0 (mm)	B0 (mm)	K0 (mm)	P1 (mm)	W (mm)	Pin1 Quadrant
TPD3S014DBVR	SOT-23	DBV	6	3000	178.0	9.0	3.23	3.17	1.37	4.0	8.0	Q3
TPD3S044DBVR	SOT-23	DBV	6	3000	178.0	9.0	3.23	3.17	1.37	4.0	8.0	Q3

TAPE AND REEL BOX DIMENSIONS

*All dimensions are nominal

Device	Package Type	Package Drawing	Pins	SPQ	Length (mm)	Width (mm)	Height (mm)
TPD3S014DBVR	SOT-23	DBV	6	3000	180.0	180.0	18.0
TPD3S044DBVR	SOT-23	DBV	6	3000	180.0	180.0	18.0

EXAMPLE BOARD LAYOUT

DBV0006A

SOT-23 - 1.45 mm max height

SMALL OUTLINE TRANSISTOR



LAND PATTERN EXAMPLE
EXPOSED METAL SHOWN
SCALE:15X



SOLDER MASK DETAILS

4214840/C 06/2021

NOTES: (continued)

- 6. Publication IPC-7351 may have alternate designs.
- 7. Solder mask tolerances between and around signal pads can vary based on board fabrication site.

EXAMPLE STENCIL DESIGN

DBV0006A

SOT-23 - 1.45 mm max height

SMALL OUTLINE TRANSISTOR



SOLDER PASTE EXAMPLE
BASED ON 0.125 mm THICK STENCIL
SCALE:15X

4214840/C 06/2021

NOTES: (continued)

8. Laser cutting apertures with trapezoidal walls and rounded corners may offer better paste release. IPC-7525 may have alternate design recommendations.
9. Board assembly site may have different recommendations for stencil design.

重要声明和免责声明

TI 提供技术和可靠性数据（包括数据表）、设计资源（包括参考设计）、应用或其他设计建议、网络工具、安全信息和其他资源，不保证没有瑕疵且不做任何明示或暗示的担保，包括但不限于对适销性、某特定用途方面的适用性或不侵犯任何第三方知识产权的暗示担保。

这些资源可供使用 TI 产品进行设计的熟练开发人员使用。您将自行承担以下全部责任：(1) 针对您的应用选择合适的 TI 产品，(2) 设计、验证并测试您的应用，(3) 确保您的应用满足相应标准以及任何其他安全、安保或其他要求。这些资源如有变更，恕不另行通知。TI 授权您仅可将这些资源用于研发本资源所述的 TI 产品的应用。严禁对这些资源进行其他复制或展示。您无权使用任何其他 TI 知识产权或任何第三方知识产权。您应全额赔偿因在这些资源的使用中对 TI 及其代表造成的任何索赔、损害、成本、损失和债务，TI 对此概不负责。

TI 提供的产品受 TI 的销售条款 (<https://www.ti.com.cn/zh-cn/legal/termsofsale.html>) 或 [ti.com.cn](https://www.ti.com.cn) 上其他适用条款/TI 产品随附的其他适用条款的约束。TI 提供这些资源并不会扩展或以其他方式更改 TI 针对 TI 产品发布的适用的担保或担保免责声明。

邮寄地址：上海市浦东新区世纪大道 1568 号中建大厦 32 楼，邮政编码：200122
Copyright © 2021 德州仪器半导体技术（上海）有限公司